

Eidg. Institut für Reaktorforschung Würenlingen
Schweiz

A Survey of the Underground Siting of Nuclear Power Plants

S. Pinto



Würenlingen, Dezember 1979

A SURVEY OF THE UNDERGROUND
SITING OF NUCLEAR POWER PLANTS

S. PINTO

Swiss Federal Institute for Reactor Research
Würenlingen, December 1979

INTRODUCTION

1. The idea of locating nuclear power plants underground is not new, since in the period of time between the late fifties and the early sixties, four small nuclear plants have been built in Europe in rock cavities.

Safety has been, in general, the main motivation for such a siting solution.

Infact, the feeling of insecurity and inadequacy of the knowledge of the nuclear phenomena that, at that time, was common in the nuclear field led to build these four plants, and to design many others, underground to achieve a safety level higher than that considered possible for a surface plant.

Since then, the interest in the underground siting has been decreasing having been possible to show that the consequences of conceivable accidents in surface plants could be kept within acceptable limits.

In the last years, however, several factors such as increasing power transmission costs, decreasing number of suitable sites above ground, increased difficulties in obtaining site approval by the licensing authorities, increasing opposition to nuclear power, increasing concern for extreme - but highly improbable - accidents, together with the possibility of utilizing the waste heat and the urban siting concept have renewed the interest for the underground siting as an alternative to surface siting.

For these reasons, a large number of studies aimed at assessing the feasibility of the underground siting and at evalua-

ting advantages, disadvantages and costs of the concept have been undertaken in various european countries and in USA.

2. The main alternatives of the underground siting concept, usually taken into account in studies on the subject, are the following:

- surface mounded

in this alternative the plant is constructed above grade and the outside surfaces of vital structures are back-filled with soil and/or special materials

- pit siting

in this alternative, also known as cut-and-cover or cut-and-fill, the plant is constructed below grade in an open cut excavation and then covered with soil and/or special material

- deep in rock

in this concept variation often referred to as rock cavity alternative, the plant is constructed in caverns excavated at depth in a rock mass.

Within these three main alternatives, several variations are possible. The plant may be totally or partially underground, the buildings may have all the same elevation as in surface plants or a different elevation, the rock cavities may be excavated in the side of a hill or deep below the surface, the excavations for the pit siting may be in soil or in rock, access to the plant may be through tunnels or vertical shafts etc.

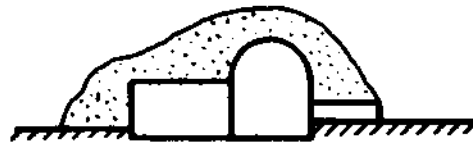

SURFACE MOUNDED

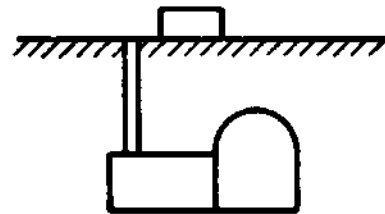
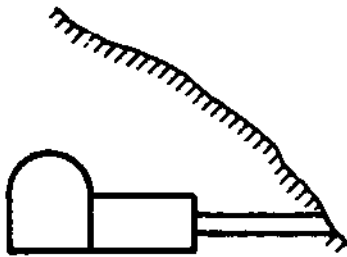

ROCK CAVITY CONCEPTS

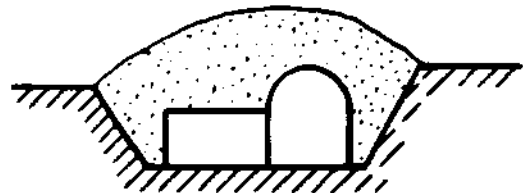
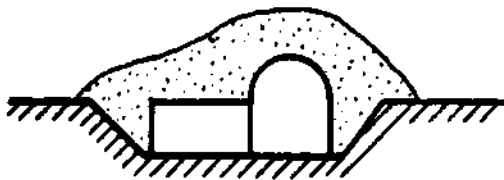

PIT SITING CONCEPTS

Fig. 1 - 1 Main underground siting concepts

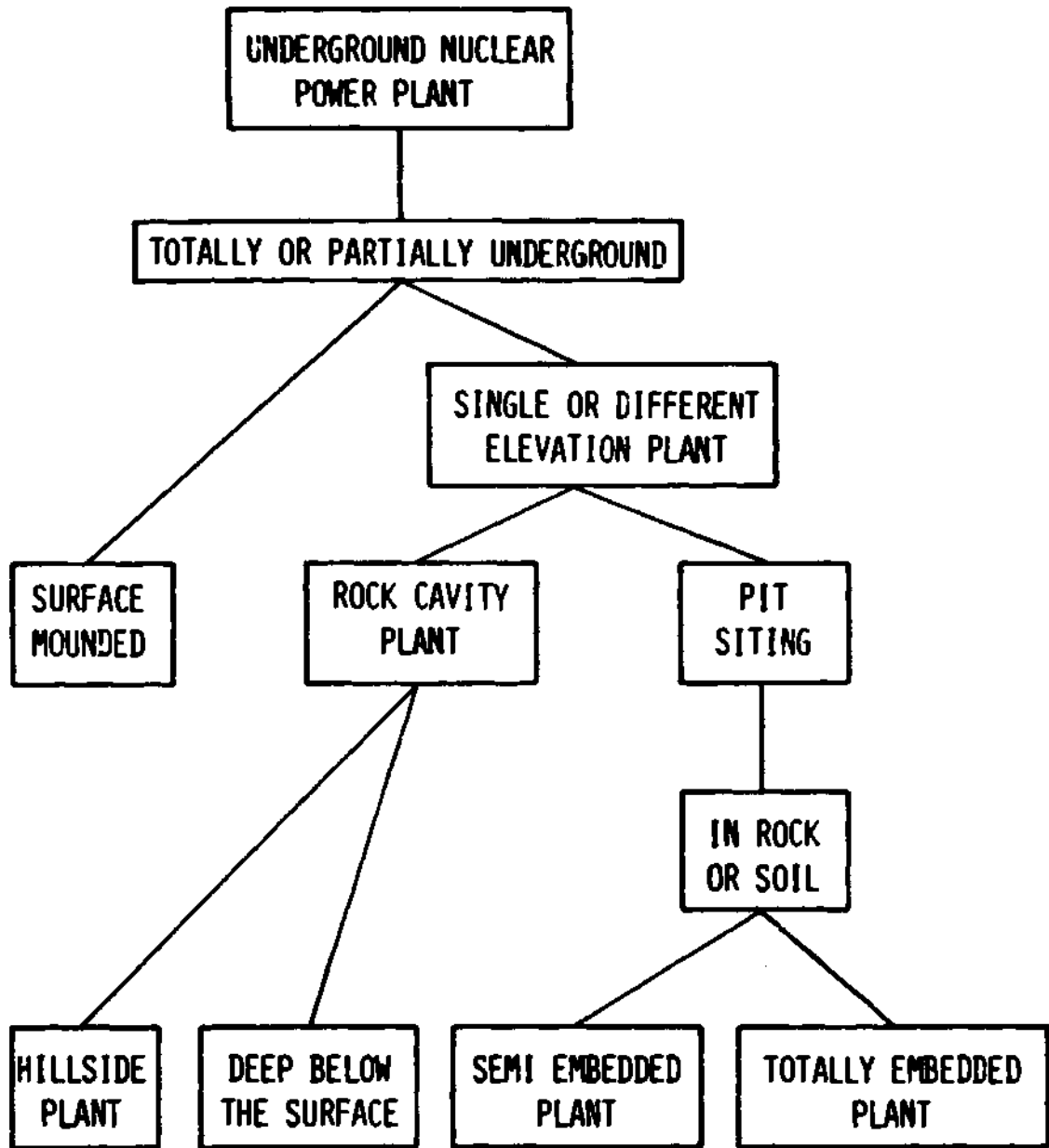

Fig. 1 - 2 Main variations of the underground siting concepts

Each variation is expected to influence both the technical and economical feasibility of the plant. However, the optimum combination of possibilities is strictly dependent on local conditions and on the aims to be achieved.

3. The existing underground nuclear facilities - Halden, a 25 MW_{th} boiling water reactor (BWR) built in Norway, Ågesta, a 80 MW_{th} pressurized heavy water reactor (PHWR) in Sweden, Chooz, a 266 MWe PWR in France, and Lucens, a 30 MW_{th} heavy water moderated, CO₂ cooled, pressure tube reactor (GHR) in Switzerland - are all rock cavity plants and have been built partially underground in hillsides in one or more cavities with access through tunnels.

The main reason for building these plants underground was to mitigate the consequences of extreme accidents.

This safety consideration, however, has not been the unique motivation. Protection against acts of war and the possibility of locating the plants in populated areas have also been major considerations in the choice of this type of siting together with economical motivations as savings in the costs of the structures and in the elimination of the conventional containment building.

4. Studies on the underground siting of nuclear power plants have been carried out in Europe and in USA since the late fifties.

In Europe, the majority of the studies performed between 1955 and 1960 were aimed at achieving, with the underground siting, a safety level higher than that considered possible,

at the time, for a surface plant. Furthermore, plant protection against acts of war was considered an important issue.

The underground location was therefore seen as a solution to those problems.

As a consequence, all the early studies (chapter 3) have investigated the rock cavity alternative with its two main variations, hillside and deep below the surface, taking advantage of the containment and protection offered by the rock.

A distinctive peculiarity of these studies is their character of preliminary project. Infact, some of the studies have actually contributed to the construction of the Lucens experimental station and of the ^CAgesta plant.

In USA, the main motivation for the studies performed in the same period of time was plant protection against enemy nuclear attack.

For a few years after the decision of building the four existing underground nuclear plants, due to a better understanding of the nuclear phenomena and to the increased level of safety of surface plants, very little interest has been shown for the underground siting concept and, as a consequence, very few studies on the subject were made.

In the last years, instead, a large number of investigations of the underground siting have been carried out. This type of siting has been infact taken into consideration as a real alternative to surface siting and also as a possible solution to problems like opposition to nuclear power, licensing difficulties, urban siting etc.

Therefore, in these last studies importance has been given,

besides to the safety potential offered by the inherent characteristics of the siting, to the technical feasibility, to the economical aspects and to identify any possible advantage and disadvantage of the concept.

In Europe, importance has also been given to power production and plant protection during wartime taking also into consideration sabotage and terrorism.

All the main alternatives of the underground siting with their main variations have been investigated. The majority of the studies however has dealt with the rock cavity alternative and the pit siting.

5. Practically all the studies have been performed basing on the same assumptions:

- the underground plant should have at least the same safety level of an equivalent surface plant
- the underground plant should satisfy the same safety standards of above ground plants

Other assumptions usually taken into account are that the underground plants should be better protected against external events (sometimes including acts of war) and that the design of the underground plant should take advantage of the inherent properties of the siting to improve safety.

The assumptions, together with the desire to maintain at least a theoretical plant licensability, have led to avoid major redesign of the reference plants.

Therefore, practically in every case, the suggested underground nuclear power plants are nothing more than a duplicate of surface nuclear power plants.

There are, however, some exceptions. For instance, an attempt of modifying the philosophy of above ground plants to better adapt them to the underground siting has been made in the studies of the Aerospace Corporation (chapter 5) where a BWR has been reconfigured eliminating the pressure suppression containment system typical of surface boiling water reactors reducing the cavern span and excavation volume relying, at the same time, on the rock for containment

Other studies as, for instance the EIR studies (chapter 6) or the California Energy Commission studies (chapter 5), have instead modified the containment philosophy proposing systems based on the pressure relief concept.

It is worthwhile to note however, that no real attempt has been made to develop an underground nuclear power plant concept capable of entirely exploiting the possibilities offered by the siting.

6. The following chapters, based on notes made by the author within the scope of a project on the underground siting of nuclear power plants he was leading at the Swiss Federal Institute for Reactor Research, highlight some of the characteristics both of the realized underground plants and of the main studies carried out on the subject.

Emphasis has been given to motivations, layout characteristics and peculiarities, plant safety features and to the main findings of the investigations.

CHAPTER 1

THE EXISTING PLANTS

<u>Contents</u>	<u>Page</u>
1.1 Introduction	1-5
1.2 The Halden boiling heavy water reactor	1-7
1.3 The Ågesta reactor	1-12
1.4 The "Centrale Nucléaire des Ardennes"	1-17
1.5 The Lucens experimental nuclear power station	1-24
1.6 Comparison among the plants	1-31
1.7 The motivations	1-33
1.8 Concluding remarks	1-38

1.1. INTRODUCTION

1.1.1. The idea of locating nuclear plants underground was, at the beginning, mainly related to minimizing the consequences of major accidents.

In fact, at the time of the construction of the unique underground nuclear plants, for instance, the "nuclear explosion", now acknowledged as an impossible phenomenon, was considered as a real possibility in a reactor.

Therefore, mainly as a solution to safety problems, in the period of time between 1955 and 1962, the construction of four underground nuclear reactors had already been started or completed.

All these plants are of the rock cavity type and have been built, partially underground, in hillsides in one or more cavities with access through horizontal tunnels.

1.1.2. All four reactors have been constructed in Europe: Halden, a 25 MWth boiling heavy water reactor (BHWR) in Norway, Ågesta, a 80 MWth pressurized heavy water reactor (PHWR) in Sweden, Chooz, a 266 MWe PWR in France, and Lucens, a 30 MWth heavy water moderated, CO₂ cooled, pressure tube reactor (GHWR) in Switzerland.

With the exception of Chooz, these plants have been built for experimental purposes or / and as prototypes for new lines of nuclear reactors and not for power production as primary aim.

Halden, Agesta and Chooz have been operated successfully for a long time while Lucens, as a result of a severe accident in 1969, has been decommissioned after some months of regular operation.

At the moment only Halden and Chooz are still in operation after the decommissioning, for economical reasons, of the Agesta plant in 1974.

- 1.1.3. A summary of the most significant features of these plants is given in Tab. 1 - 1 and 1 - 2 while a short description follows in the next paragraphs.

1.2. THE HALDEN BOILING HEAVY WATER REACTOR

1.2.1. Halden, in Norway, is a boiling heavy water reactor (BHWR) rated at 25 MWth.

This reactor, built for experimental purposes and to provide steam to a paper factory after completion of the experimental work, reached criticality in June 1959 and full power operation with the second fuel charge, in October 1962. Excavations and blasting on site were started in November 1955 and all civil engineering work was completed in October 1957.

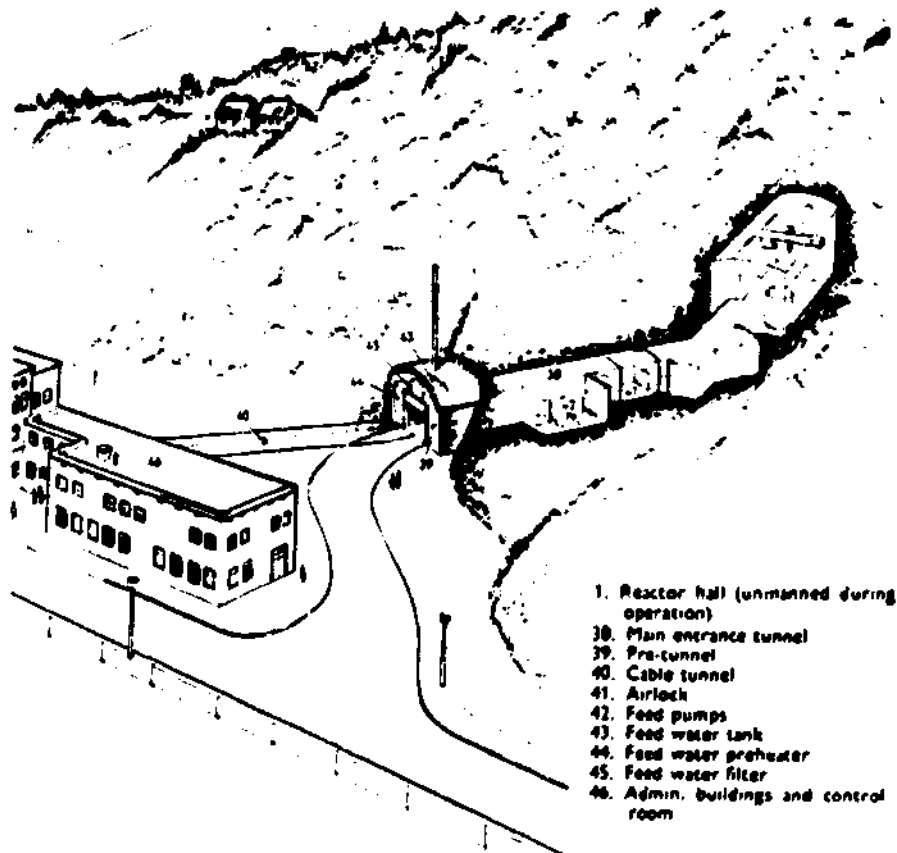

Fig. 1 - 1 Outline drawing of the Halden plant (1959)

The plant is located in Halden, a coastal town in south-east Norway, about 120 km from Oslo and close to the Swedish border, near the premises of a large paper factory, on the north bank of the river Tista. In the area of the reactor, 5500 people live within 1 km from the site and 12,000 within 1.5 km (1967 data).

1.2.2. The entire installation, with the exception of the control room and the emergency diesel engine, is contained in rock in a hill-side. The reactor is located in a cavern, rectangular in shape with an arched roof, 30 m long, 10.5 m wide and 26 m high at the center of the roof span, with a minimum rock overburden of 30 m and a maximum of 60 m.

The cavern is lined with painted concrete 15 - 30 cm thick. Concrete is also used for the flooring and foundations for the reactor. The height from the floor level to the roof is 12.5 m and from the floor level to the lowest sump is about 15.5 m (Fig. 1 - 2).

To simplify the construction, and also to meet space requirements under the main floor level, the rock walls have been stepped by 2.5 m into the plant, directly under the floor level.

The foundations contain three large pits, one for the reactor, one for the auxiliary equipment (D₂O storage tank, pumps etc.) and one for the storage of large contaminated components. A smaller pit is also provided for the fuel elements storage.

In the reactor hall there is a 50 ton crane utilized during the erection period and for servicing and refueling.

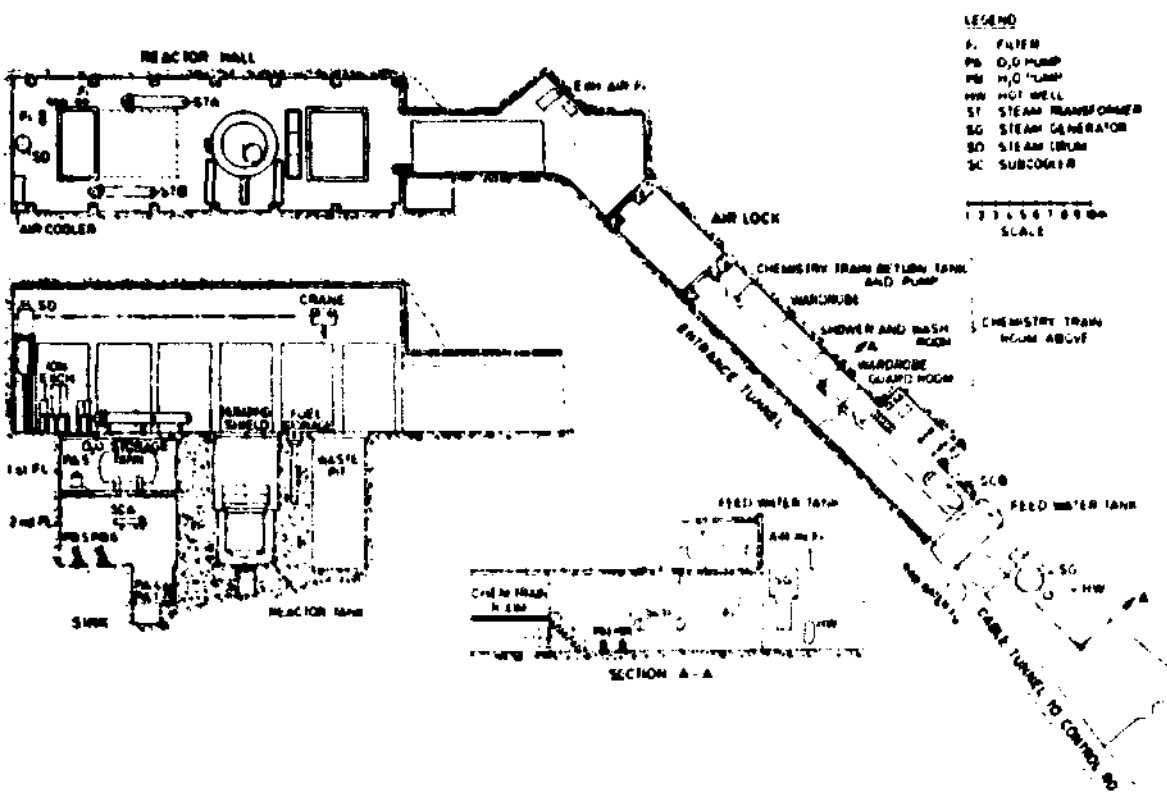

Fig. 1 - 2 Halden plant layout

The reactor hall is not accessible during plant operation.

- 1.2.3. Connection to the outside is through a 59.5 m long tunnel (including a concrete "pretunnel" section) fitted with two pressure-tight doors, 7 m apart, to provide an airlock between the reactor hall and the entrance of the tunnel. The steel doors, electrically interlocked, are designed to withstand an overpressure of 3 kg/cm^2 .

The tunnel is built with an angle in the horizontal plane, before the reactor cavern, to provide a shockwave pocket. All cables and piping to the reactor, including the ventilation system, go through this tunnel. The feedwater tank, filters and preheaters are located in the concrete pretunnel section, triplicating in that way the piping required, since the water from the feedwater tank flows to the reactor hall and, there, through the low-temperature coolers, then returns to the pretunnel section to the preheater and to the deaeration systems and then back to the reactor hall through the feedwater pumps which are located very close to the concrete section of the tunnel.

This arrangement has been chosen to save considerable amount of space in the reactor cavern and to leave the pumps, tanks, filters and preheaters outside the airlock so that they can be accessible and inspectionable at any time, since access to the reactor hall is impossible during the operation of the plant.

A cable duct, also used as a walking passage connects the plant with the basement of the control building.

1.2.4. The reactor cavern is not gas-tight. The leak rate from the reactor hall at 0.25 bar overpressure is 1 % of volume per hour. This is mainly due to the fact that, between the reactor hall and the access tunnel, the rock is cracked because of the blasting. It has been, however, recognized that, with a proper pre-planning and design of the air-lock a better leaktightness could have been achieved.

1.2.5. The excavations, for a total of about 8900 m³, are in gneiss.

Fissures formed by dislocations are distributed through the rock and are filled with stone powder and chloritic materials formed by the leaching of gneiss. About 10 % of the total material in the cracks is montmorillonite clay.

The rock quality has been the limiting factor for the maximum width of the reactor cavern, while the height has been fixed by lifting requirements.

Groundwater flows slowly but continuously through the rock into the reactor hall and is collected in a sink in the lowest part of the excavation, at a rate of about 1 m³/hr. This inleakage has been found to be independent of the weather conditions.

1.2.6. In the case of accidents, fast-acting automatic valves are provided for to block the ventilation ducts and a water spray system is installed to flush the cavern walls and ceiling to minimize the contamination of concrete surface and to quench the steam pressure.

1.3. THE AGESTA REACTOR

1.3.1. Agesta was a pressurized heavy water cooled and moderated reactor, fueled with natural uranium in oxide form, rated at 80 MWth.

This experimental installation meant to provide experience for future reactors, has been developed in 1958 from the combination of two older projects, Adam and R3.

Adam was a pressure-vessel reactor intended only for the production of heat, whereas R3 was a pressure-vessel reactor for the combined production of heat and electricity. Since it became apparent that neither of these two projects could be alone economically competitive, they were combined in one plant, Agesta or R3/Adam.

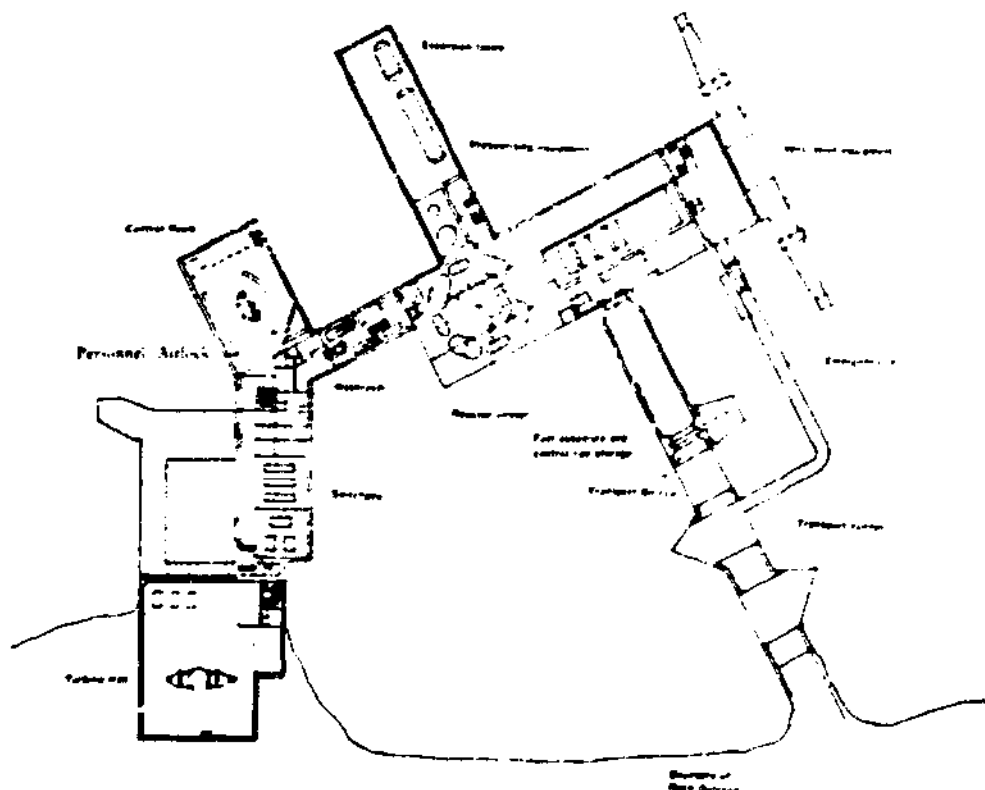

Fig. 1 - 3 Agesta plant layout

The reactor was located in Ågesta, about 14 km south of Stockholm, the site being 3 km from a populated area of 30,000 inhabitants (1961 data). The plant, which reached criticality in July 1963 and went into operation in March 1964, was producing 20 MW of electricity and providing 60 MW to the district heating system of the Stockholm suburb of Farsta.

Because of economical considerations it has been decommissioned in 1974.

- 1.3.2. The reactor, the control room and the reactor auxiliary systems were located in rock in a hillside whereas the turbine (back pressure type) was in a conventional turbine building above ground.

The dimensions of the cavern containing the reactor building were 16.5 m width, 53.5 m length and 40 m height. The minimum rock overburden above the reactor hall was about 15 m.

The reactor was situated in the northern part of the reactor building together with the main steam generators which were distributed around the reactor, outside the iron-ore concrete radiation shield. The fuel storage facilities, ion-exchange equipment and other auxiliary systems were located in the middle of the hall, while the southern area of the building was occupied by service facilities for the refueling machine, by storage tanks for D_2O , H_2O etc.

In the eastern wall, an off-shot of the main containment contained the expansion tanks of the pressure control systems.

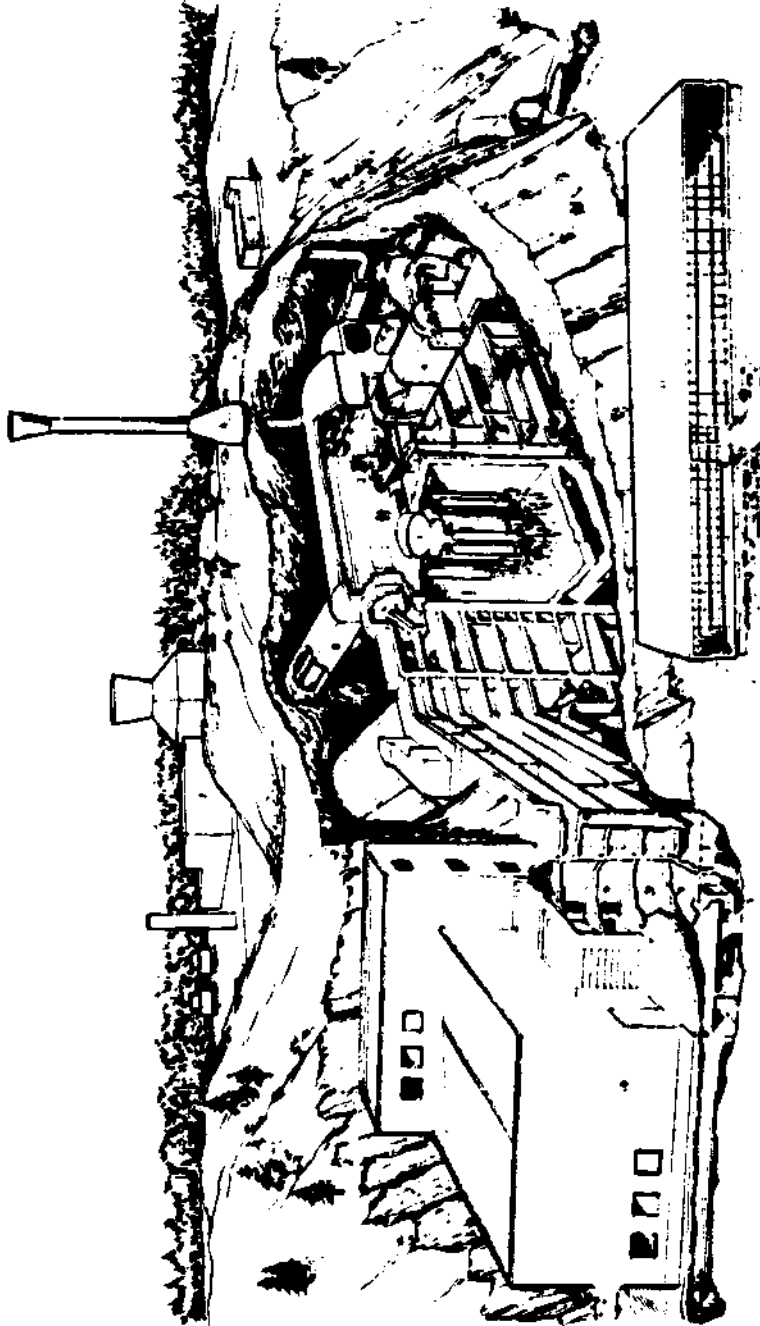

- 1 Reactor
- 2 Refuelling machine
- 3 Fuel storage facilities
- 4 Transport airlock
- 5 Inlet for ventilation air
- 6 Outlet for exhaust air
- 7 Water reservoir
- 8 Pressuriser and expansion tanks
- 9 District-heating network
- 10 Turbine hall
- 11 Offices

Fig. 1 - 4 Outline drawing of the Ågesta plant

Three vertical shafts connected the plant to the top of the hill.

One, at the northern end of the cavern was connected with the cooling towers, the other two, at the southern end, were used for the reactor cavern ventilation.

In the reactor hall, there was a 120 ton overhead crane.

1.3.3. The reactor cavern was lined with concrete and welded steel plates 4 mm thick for the walls and the ceiling and 8 mm for the floor to provide a completely gas-tight containment since the plant was very close to Stockholm. The leaktightness requirements raised a lot of problems since there were, besides three access airlocks, more than 400 cable penetrations and other ducts. However, the reactor cavern underwent pressure tests up to two atmospheres in 1962 and the leakage rate from the entire inner containment surface area of 8000 m², including doors and ducts, was found to be equivalent to that from a 4 mm diameter hole.

In case of accidents, it was possible to isolate the containment with fast-acting valves of 1 m² section, in the ventilation ducts, closing within 7/10 of a second.

1.3.4. Access to the plant was by means of three airlock tunnels, the largest permitting road transports to enter the fuel handling area in the reactor hall for removal of spent fuel flasks. In this tunnel shock-wave pockets were provided for. The other two were personnel airlocks with a capacity of 10 persons each. The one near the control room was

utilized as the normal entrance while the other one, near the transport tunnel, was used only as an emergency exit.

- 1.3.5. The underground excavations, which included also the control room, for a total of about 60,000 m³ were in gneiss and granite. It must be noted that the rock quality was such as to limit the width of the reactor hall. The site, however, was chosen because it was the only one of sufficient size within acceptable distance of Farsta.

The plant construction took five years from the first opening of the work site until final start-up and two and a half years for preconstruction planning and design. The excavation of the cavities, which started in November 1957, was completed in January 1960.

1.4 THE "CENTRALE NUCLEAIRE DES ARDENNES"

- 1.4.1. The "Centrale Nucléaire des Ardennes" owned by SENA is a Westinghouse PWR rated 266 MWe* and, until now, is the largest existing underground nuclear plant.

This plant, built for power production, reached criticality in October 1966 and full power operation in April 1967. The construction was started in February 1962. The plant is located in Chooz, France, near the Belgian border, 8 km south of Givet, on the river Meuse, where the cooling water is taken from. The existing population, within a 30 km radius from the site, is about 200,000 individuals (1966 data).

- 1.4.2. This plant is partially located in rock, in a hillside. The underground portion of the plant consists of three caverns and connecting galleries. The caverns house respectively the reactor with four primary loops, the auxiliary systems and the fuel storage and handling facilities, and the electrical equipment while the turbogenerator group, the control room, the water deperation systems etc. are above ground.

Because of this layout, the steam pipes connecting the steam generators to the turbine are, on the average, 200 m long causing then a pressure drop of about 2.4 kg/cm^2 .

- 1.4.3. The reactor cavern, which is connected to the outside through a gallery of 40 m^2 section and 120 m long, is

* the plant has been recently updated to 305 MWe

18.5 m wide, 41 m long and 42.8 m high and is lined with 3 mm thick steel plates to provide a gastight containment. This cavern, designed to withstand the maximum temperatures and pressures of a loss-of-coolant accident (140 °C and 4 kg/cm²), has been tested for leaktightness at a maximum pressure of 0.7 kg/cm².

To relieve possible hydrostatic pressures on the liner, a drainage system consisting of vertical channels in the walls and a collecting gallery below the reactor has been provided for.

The reactor cavern is not accessible during plant operation.

The cavern housing the auxiliary systems and the fuel storage and handling system is 49 m long, 15 m wide and 42 m high and has been built like a hydroelectric plant cavern, without any special leaktightness requirements. The distance that separates this cavern from the reactor cavern is about 26 m. This distance is the result of a compromise between the interest to have short connections between the two caverns and the necessity to have a suitable rock separation to avoid a collapse of the cavities.

Partially between these two caverns, there is the electrical equipment cavern. This cavern is quite small as compared to the others, the dimensions being 25 m length, 5.10 m width, 12.5 m height.

The location of this cavern has been chosen in order to keep the cables length as short as possible.

Galleries containing the fuel transfer system, ventilation ducts, electrical cables, piping etc. connect the various caverns.

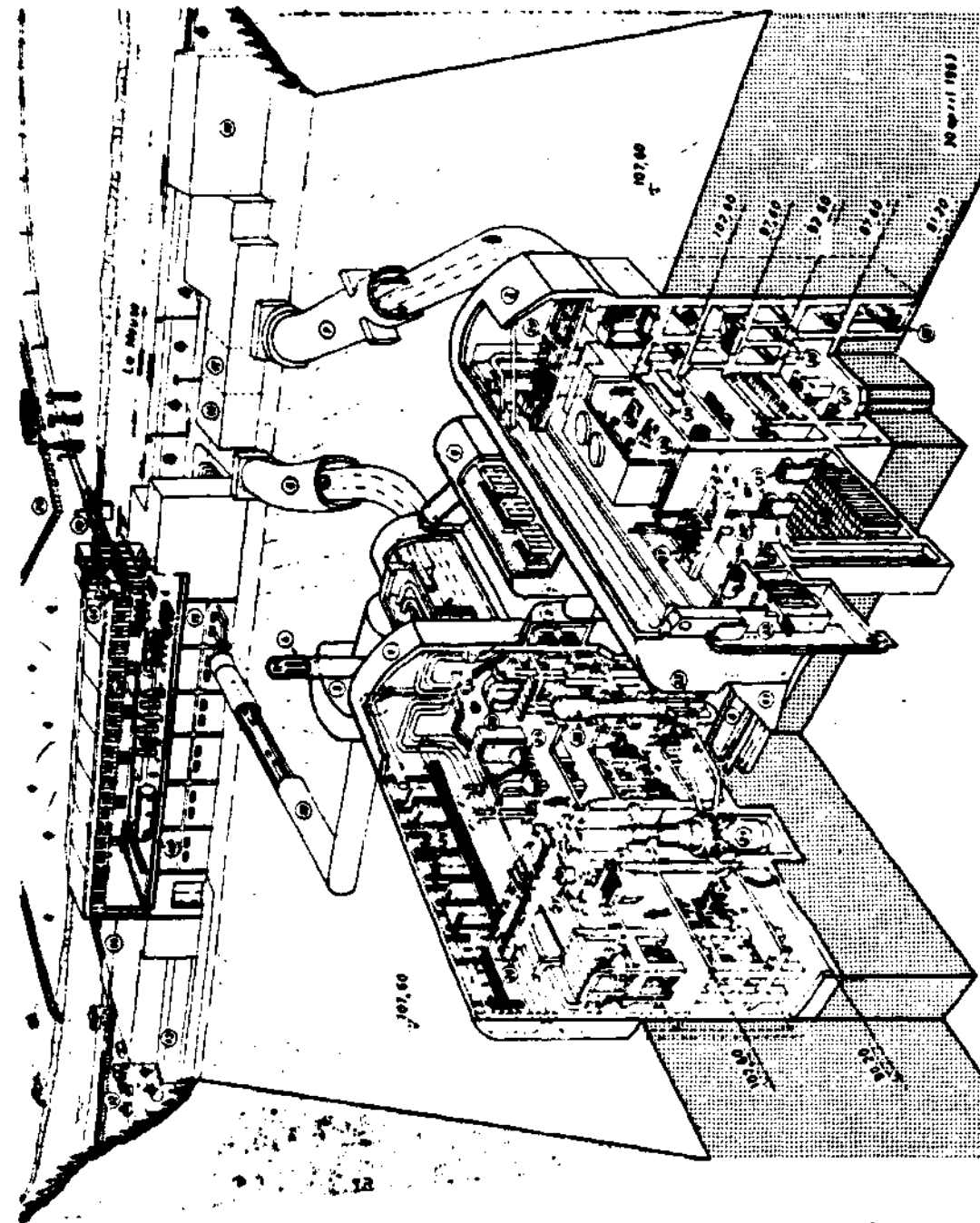

- UNDERGROUND WORKS**
- 1 Reactor cavern
 - 2 Auxiliary equipment cavern
 - 3 Steam drums
 - 4 Steam safety valves vent
 - 5 Electrical equipment cavern
 - 6 Reactor cavern access tunnel
 - 7 Auxiliary cavern access tunnel
 - 8 Fuel transfer tube gallery
 - 9 Cable gallery
 - 10 Steam piping gallery
 - 11 Ventilation gallery
- SURFACE WORKS**
- 12 Pump house
 - 13 Perforation
 - 14 Warehouses and workshops
 - 15 Turbine building
 - 16 Ventilation building
 - 17 New fuel storage building
 - 18 Waste handling building
 - 19 Access bridge
 - 20 Switchyard
- EQUIPMENT**
- 21 Reactor
 - 22 Steam generator
 - 23 Primary pump
 - 24 Pressurizer
 - 25 Ventilation
 - 26 Overhead crane
 - 27 Canteen
 - 28 Main tank
 - 29 Overhead crane
 - 30 Spent fuel pit
 - 31 Spent fuel cask
 - 32 Spent fuel rack
 - 33 Ventilation shaft
 - 34 Chemical control system
 - 35 Intermediary coolers
 - 36 Bechtel heat removal heat exchangers
 - 37 Safety injection pumps
 - 38 Drainage water tank
 - 39 Turbogroup
 - 40 Water reserve tank
 - 41 Feedwater tank

Fig. 1 - 5 The Centrale Nucléaire des Ardennes (SENA)

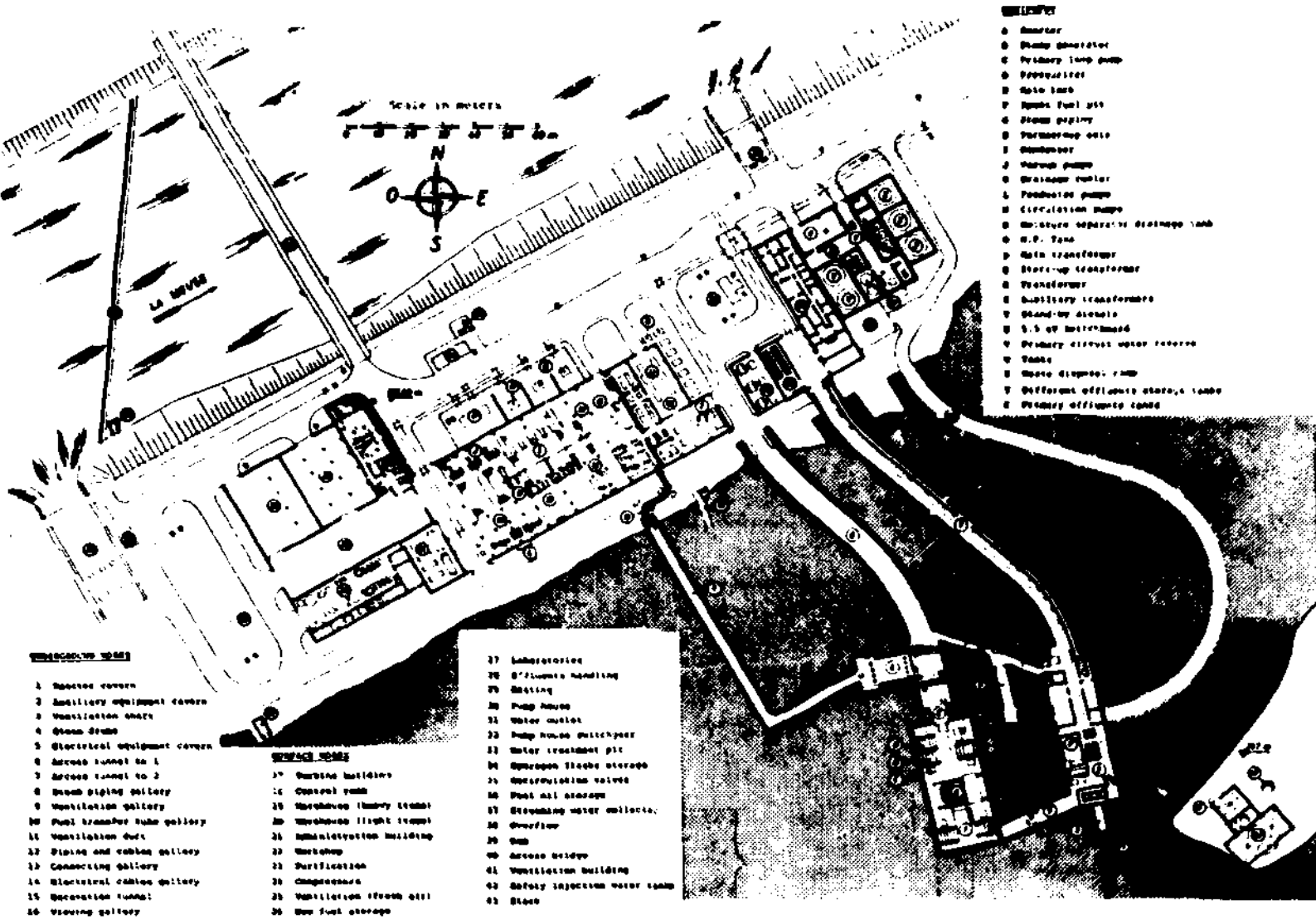

REACTOR ROOMS

- 1 Reactor covers
- 2 Auxiliary equipment covers
- 3 Ventilation shafts
- 4 Steam drums
- 5 Electrical equipment covers
- 6 Access tunnel to 1
- 7 Access tunnel to 2
- 8 Steam piping gallery
- 9 Ventilation gallery
- 10 Fuel transfer tube gallery
- 11 Ventilation duct
- 12 Piping and cables gallery
- 13 Connecting gallery
- 14 Electrical cables gallery
- 15 Recreation tunnel
- 16 Working gallery

SERVICE ROOMS

- 17 Service building
- 18 Control room
- 19 Warehouse (heavy items)
- 20 Warehouse (light items)
- 21 Administration building
- 22 Workshop
- 23 Purification
- 24 Compressor
- 25 Ventilation shaft exit
- 26 Raw fuel storage

LABORATORIES

- 27 Laboratories
- 28 Effluents handling
- 29 Mixing
- 30 Pump house
- 31 Water meter
- 32 Pump house discharge
- 33 Water treatment pit
- 34 Storage tanks storage
- 35 Distribution valves
- 36 Fuel oil storage
- 37 Stripping water collector
- 38 Overflow
- 39 Dam
- 40 Access bridge
- 41 Ventilation building
- 42 Safety injection water tank
- 43 Stack

ELECTRICAL

- 44 Generator
- 45 Primary loop pump
- 46 Feedwater
- 47 Steam tank
- 48 Steam fuel gas
- 49 Steam piping
- 50 Transformer case
- 51 Condenser
- 52 Water pump
- 53 Drainage cooler
- 54 Feedwater pump
- 55 Circulation pump
- 56 Moisture separator drainage tank
- 57 H.P. Tank
- 58 Main transformer
- 59 Start-up transformer
- 60 Transformer
- 61 Auxiliary transformer
- 62 Stand-by diesel
- 63 5.5 kv switchboard
- 64 Primary district water reserve
- 65 Tanks
- 66 Waste disposal ramp
- 67 Effluent effluents storage tank
- 68 Primary effluents tank

Fig. 1 - 6 SENA plant layout

1.4.4. Connections to the outside are through two main tunnels leading respectively to the reactor cavern (at elevation 107.60) and to the auxiliary systems cavern. The dimensions of these tunnels are such as to allow the transport of large components.

The steam pipes run through a separate tunnel, about 170 m long, to the turbine building above ground.

A long gallery, with a large bend, connecting the bottom of the reactor cavern to the outside, has been constructed to remove the débris of the excavations.

1.4.5. The underground excavations, reaching a total of about 95,000 m³, are in chalk and shale.

It should be noted that the dimensions of the caverns have been fixed by the equipment to be installed and by the required accessibility for servicing and repair and not by the rock quality. However, the rock instability in a certain area, caused a delay in the execution of civil engineering work.

The total plant construction took four years including the design, the civil engineering work three years.

1.4.6. The Chooz nuclear power plant has two very particular characteristics, the safety injection system and the spent fuel transfer system.

Two reservoirs containing in total about 1300 m³ of borated water are installed on the hill housing the plant, about 200 m above the reactor level. These two reservoirs ensure

by gravity water injection in the reactor core and water spraying in the cavern in case of an accident.

Because of the distance of about 30 m between the reactor and the spent fuel pool in the auxiliary systems cavern, a new fuel transfer system has been developed. This system consists of a tube of 40 cm diameter, a small wagon to carry the fuel elements and two pistons: the motion of this wagon inside the tube is obtained by the differential pressure of the water on the two pistons.

1.5. THE LUCENS EXPERIMENTAL NUCLEAR POWER STATION

1.5.1. The Lucens plant was a heavy water moderated, Co_2 cooled, pressure tube reactor fueled with slightly enriched uranium.

The plant, purely experimental, meant as a prototype for a new line of reactors, was located in Lucens, Switzerland, about 25 km north of Lausanne, on the left bank of the river Broye.

In the area of the reactor 175 persons/km² lived within a 2 km radius from the site (1966 data).

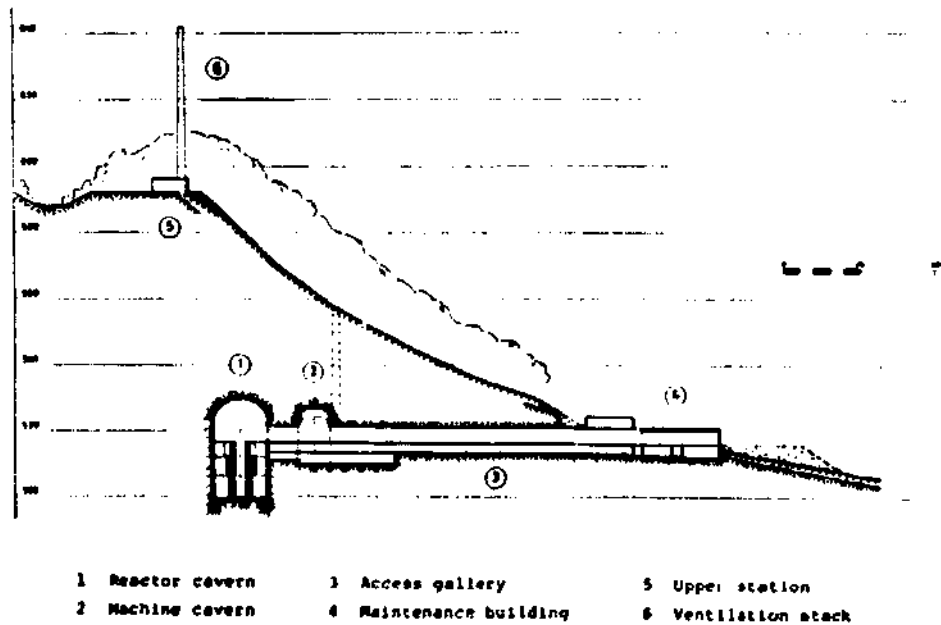

Fig. 1 - 8 Transverse section of the Lucens plant

The construction of the plant was started in August 1962 and the first reactor criticality was achieved on the 29th December 1966. Regular operation was started, however, in May 1968. After a short period the reactor was shutdown for research and testing before being started up again on the 14th August. The plant was then operated successfully until the 24th October, when it was shutdown again for some corrective work. On the 21st January 1969, during start-up, a serious accident with coolant and moderator losses and fuel element damages took place.

As a consequence of this event, the plant has been decommissioned.

The power rating of this experimental plant was 30 MWth and 8.5 MWe.

- 1.5.2. The underground portion of the plant, in a hillside, consists of three caverns housing respectively the reactor, the turbine and the fuel elements storage pool.

The reactor, the primary loop, two steam generators, the charge and discharge machine and various reactor auxiliary systems were housed in the reactor cavern. This cavern, cylindrical with a domed roof, with a diameter of 17 m and a maximum height of 30 m, was lined with porous concrete (utilized also for the drainage of the groundwater), alternate layers of bitumen and aluminium foils and reinforced concrete to achieve the required leaktightness.

The leaktightness specification for the airlocks, the penetrations and ducts were such as to allow, also in case

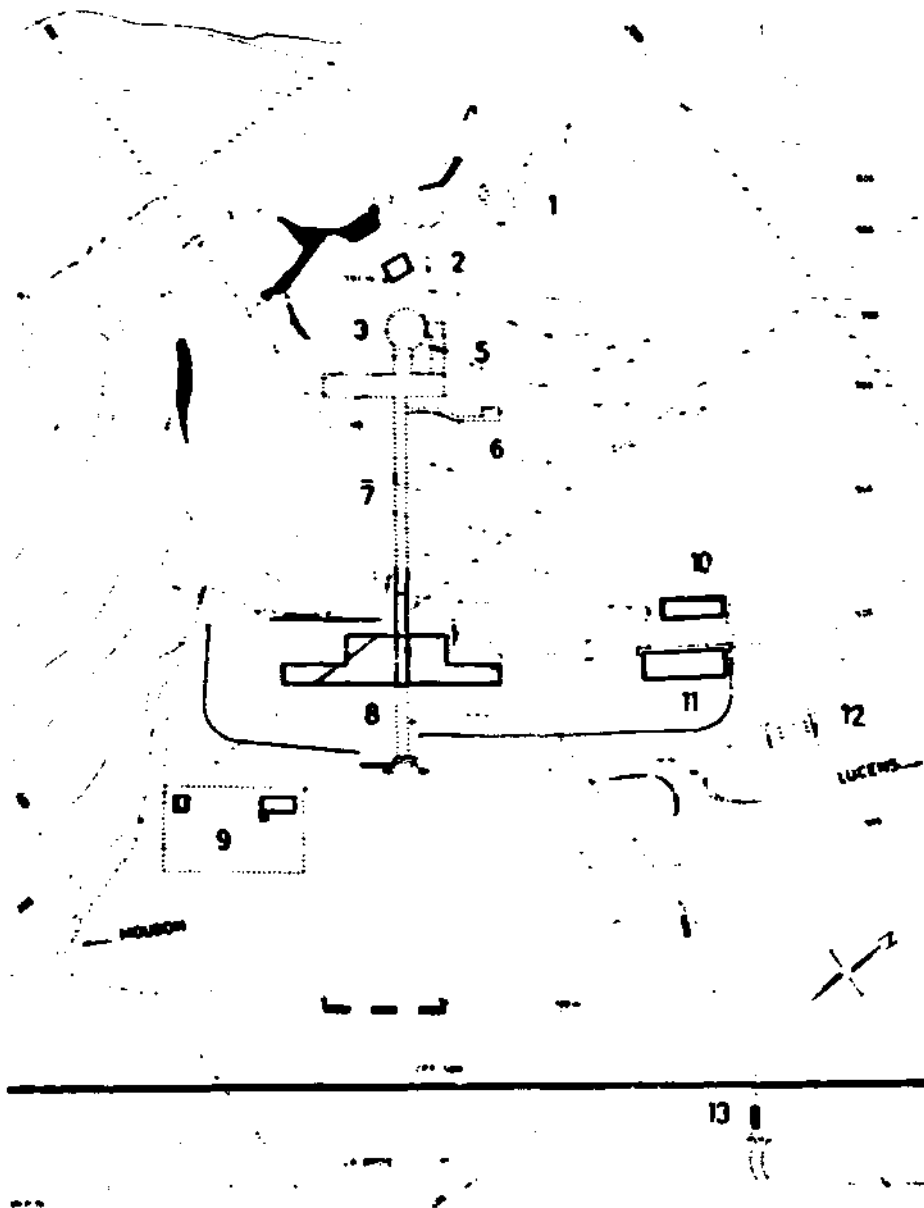

- | | | |
|-------------------------------|----------------------------|------------------------|
| 1 Reservoir | 6 Departmental covers | 10 Water preparation |
| 2 Upper installation and work | 7 Access gallery | 11 Cooling tower |
| 3 Reactor covers | 8 Maintenance building | 12 Transformer station |
| 4 Machine covers | 9 Waste treatment building | 13 Pumping station |
| 5 Fuel storage covers | | |

Fig. 1 - 9 Lucens site plan

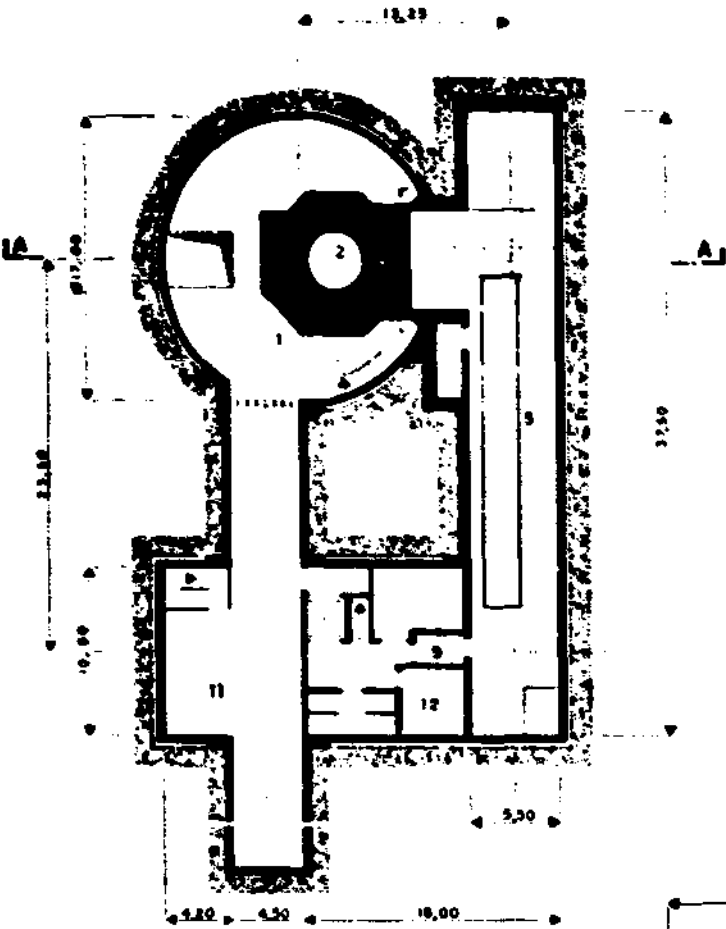
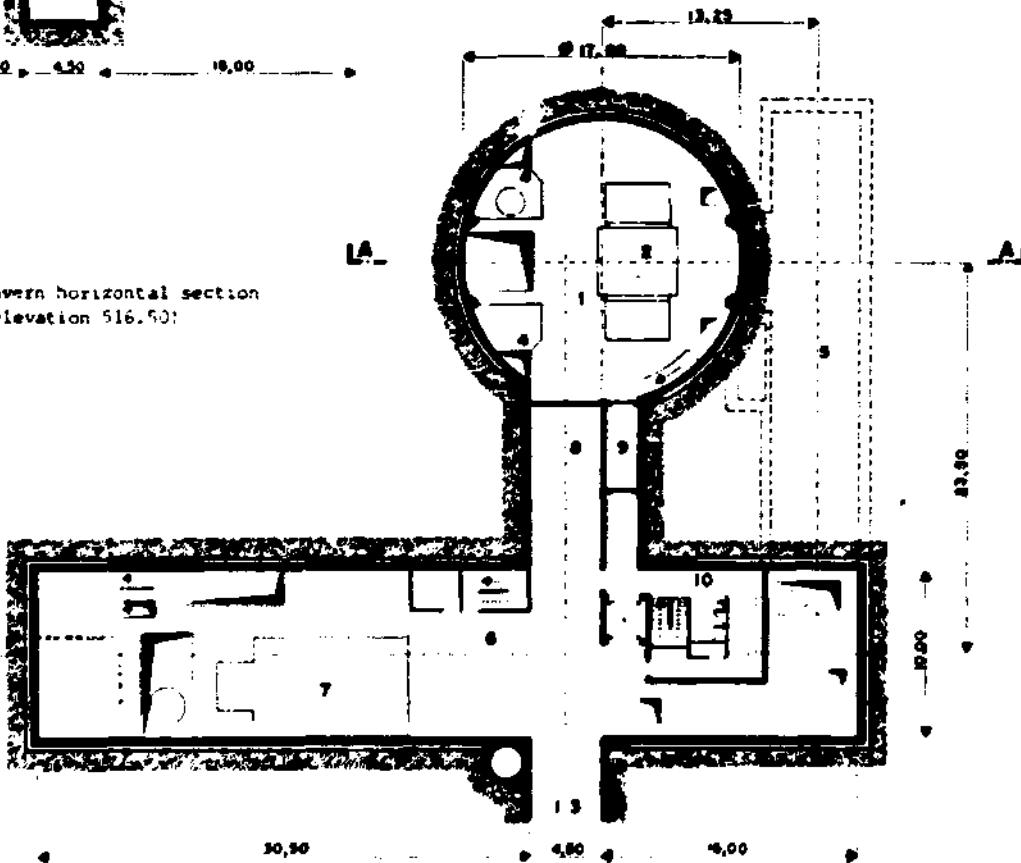

Fig. 1 - 10 Cavern horizontal section (elevation 408.00)

- 1 Reactor cavern
- 2 Reactor
- 3 Charge / discharge machine room
- 4 Steam generator
- 5 Fuel storage cavern
- 6 Machine cavern
- 7 Turbogroup
- 8 Equipment gallery
- 9 Personnel airlock
- 10 Personnel control
- 11 Electrical equipment room
- 12 Fuel storage cavern ventilation
- 13 Access gallery

Fig. 1 - 11 Cavern horizontal section (elevation 516.50)



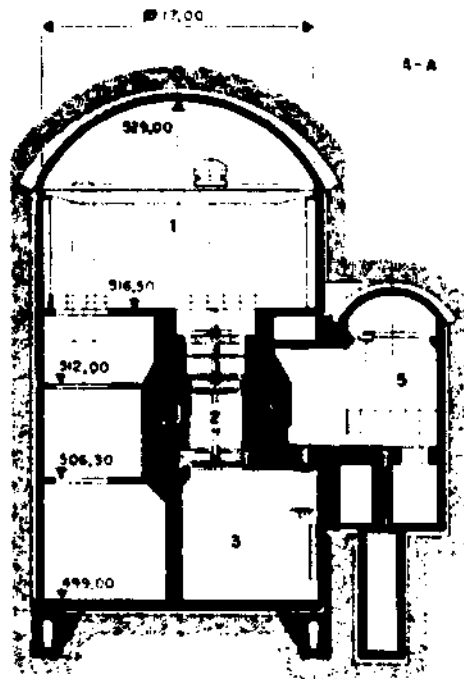

Fig. 1 - 12 Cavern vertical section

- 1 Reactor cavern
- 2 Reactor
- 3 Charge/discharge machine room
- 5 Fuel storage cavern

of major accidents, the direct ventilation of the machine cavern and of the access gallery.

The access to the reactor cavern was sealed by a large steel wall comprising two airlocks, the equipment hatch and penetrations for piping and cables.

A short tunnel with an airlock connected the reactor hall with the machine cavern.

In the machine cavern the turbogroup and auxiliaries were housed in the south-west part of the cavern together with some ventilation equipment.

Electrical equipment was located in the middle of the cavern,

while the monitoring and decontamination facilities for operators and equipment, the purification system for the fuel pool etc. were located in the north-east part of the cavern. The dimensions of this cavern were 51 m maximum length, 10 m width and about 18 m height.

A ventilation shaft was driven through the rock from the machine cavern up to the surface. It was followed by a duct on the slope of the hill reaching the bottom of the stack on the ridge of the hill. The stack height was about 50 m.

The fuel storage cavern, located perpendicularly to the machine cavern was 37.5 m long, 5.5 m wide and about 15 m high. A special passage was provided for transfer of fuel elements from the reactor hall to the fuel pool.

The irradiated fuel elements, after removal from the storage pool, were taken through the end of the machine hall. Access to this cavern was through the lower floor of the machine cavern.

An experimental cavern, with a volume of 140 m^3 was also excavated at the site for small scale simulation of construction methods as various types of lining etc. (see Fig. 1 - 9).

1.5.3. A two level gallery, about 100 m long, connected the underground cavities with the service building on the outside where the control room, the diesel generator sets, workshops, offices etc. were housed.

Cables and ducts run in the lower level of this tunnel.

The cooling tower, the switchyard and the waste disposal station were located close to the service building. On the hill, besides the ventilation stack, there were the ventilation building and a tank containing about 500 m³ of water constituting the plant water reserve.

1.5.4. All the underground excavations were in sedimentary molasse. The average rock overburden was of 30 m with a maximum of about 54 m above the reactor cavern. The ground-water inseeepage rate in the reactor hall was about 5 m³ a day.

1.5.5. This plant had a very particular safety feature. Infact, in the case of an accident associated with a pressure build-up in the reactor cavern, the pressure could be relieved to the porous concrete surrounding the cavern, through valves penetrating the containment walls.

Due to this drainage porous concrete, the gases could be uniformly distributed around the cavern and, then, under the driving force of the overpressure could gradually flow into the rock which, in Lucens, has a high porosity but a low permeability.

Filters installed before the relief valves provided a filtration of particulate contaminants.

1.6. COMPARISON AMONG THE PLANTS

1.6.1. Even if different for what concerns the purpose, the general plant concept, the reactor type, the power rating etc., these four underground nuclear plants have some common characteristics:

- they are all rock cavity plants, partially underground, in a hillside
- they are all single elevation plants
- they are all small experimental or prototype plants with power ranging from 8.5 to 305 MWe
- they have all relatively small cavern spans (ranging from 10.5 m in Halden to 18.5 m in Chooz) compared with those required for a 1000 MWe nuclear power plant (40 to 50 m)
- in all plants there is no conventional containment but just some sort of lining for the reactor cavern
- they have all been located in populated areas

1.6.2. The unique existing type of underground nuclear plant is then the hillside rock cavity plant. Other underground concepts as the "pit" siting or the "deep below the surface" siting have not been taken into account.

Furthermore, it should be noted that, besides the utilization of the rock mass as an additional containment, in these facilities, advantage of the inherent characteristics

of the underground siting has been taken only in the case of the gravity fed emergency water injection and spray system for the reactor core and reactor cavern in the Chooz plant and in the case of the overpressure relief system in the reactor cavern of the Lucens plant. Other possibilities offered by the underground siting as, for instance, a different cavern elevation, have not been considered.

1.7. THE MOTIVATIONS

1.7.1. As previously stated, one of the main reasons for the construction of these underground nuclear plants was to mitigate the consequences of major accidents. This safety consideration, however, has not been the unique motivation.

It is then interesting to examine, more in detail, the motivations that have led to the siting of these reactors underground.

The main reasons, for each plant, are given below.

HALDEN

"Several locations for siting were considered, on the basis of general safety, availability of water and power ... It was natural for the containment to be thought of in terms of locating the plant inside rock." (Ref. 1 - 1)

"In Norway ... the rock containment differs very little in cost from a conventional building and is considerably cheaper than a steel containment such as a sphere." (Ref. 1 - 2)

To locate "the reactor in a comparatively densely populated area." (Ref. 1 - 3)

"Explosion resistance can be obtained." (Ref. 1 - 3)

AGESTA

"The object of placing the reactor chamber in rock is to eliminate as far as possible the risks to the surrounding population in connection with a reactor accident " (Ref. 1 - 7)

" ... close location of reactors to communities necessary for district heating schemes" (Ref. 1 - 8)

"protection against demolition during wartime is easily achieved" (Ref. 1 - 8)

CHOOZ

" ... the desirability of this approach from the safety angle is obvious ... " (Ref. 1 - 11)

" ... estimate for costs indicate that there should be no penalty in comparison with a normal above ground construction" (Ref. 1 - 11)

LUCENS

"Underground construction is particularly suited to Swiss conditions and it has often been adopted for the construction of hydroelectric plants. The experience thus gained and the inherent advantages from the point of view of safety have played a decisive role in accepting this construction technique for the first nuclear power plant in Switzerland" (Ref. 1 - 13)

"The mechanical properties of the rock reduce the cost of the structural part of the buildings and, because of the homogeneity of the rock texture, also the cost of the shielding is reduced. There is no need for a steel containment shell." (Ref. 1 - 12)

Moreover, national defense has been a major consideration in the decision of siting underground the plants of Halden, Ågesta and Chooz. (Ref. 1 - 16)

1.7.2. In summary, as it also clearly appears from this short review, the main reasons that have lead to the underground siting of these four nuclear reactors are:

- greater safety in case of major accidents because of an additional level of containment
- protection against acts of war
- possibility of siting the plants in populated areas
- economic considerations

PLANT	REACTOR TYPE AND RATING	YEAR OF OPERATION	PLANT PURPOSE	PLANT CONFIGURATION	CONTAINMENT TYPE AND DIMENSIONS (l x w x h) m	ROCK TYPE OVERBURDEN
HALDEN	BHWR 25 MW _{th}	1962	- experimental - steam production	hillside plant in rock cavities partially underground no turbine	rock excavation lined with painted concrete 30 x 10.5 x 26	Gneiss min 30 m max 60 m
ÅGESTA	FWWR 80 MW _{th}	1964	- experimental - heating and power production	hillside plant in rock cavities partially underground turbine above ground	rock excavation lined with steel plates 53.5 x 16.5 x 40	Gneiss/Granite min 15 m
CHOOZ	SWR 100 MW _{th} 100 MW _e 100 MW _{th}	1967	- power production	hillside plant in rock cavities partially underground turbine above ground	rock excavation lined with steel plates 41 x 18.5 x 42.8	Gneiss/Granite
LUCENS	GHWR 7.5 MW _e net (30 MW _{th})	1968	- experimental - power	hillside plant in rock cavities partially underground turbine in cavern	cylindrical rock excavation lined with a sandwich construction: concrete, aluminium foils in bitumen, concrete Ø = 17 m h = 30 m	Sedimentary molasse 30 m average

Table 1 - 1 The existing underground nuclear plants: main characteristics (Ref. 1 - 4)

PLANT	TOTAL EXCAVATION VOLUME (m ³)	REACTOR CAVERN VOLUME (m ³)	REACTOR CAVERN SPAN (m)	EXCAVATION TIME (months)	CIVIL ENGINEERING WORK COST (% total costs)
HALDEN	8900	5600	10.5	≈ 23	10.5
AGESTA	60000	30000	16.5	≈ 26	17.5
CHOOZ	85000	36000	18.5	≈ 36	20
LUCENS		6300	17.0	≈ 10	

Table 1 - 2 The existing underground nuclear plants: some excavations characteristics

1.3. CONCLUDING REMARKS

1.8.1. Until now only four small underground nuclear plants have been built and operated. All four plants have been built in Europe and, at the moment, only two are still in operation.

A summary of the most significant features of these plants, with special emphasis on the "underground" characteristics, is given in Table 1 - 1 and 1 - 2.

1.8.2. These plants are all hillside rock cavity plants, only partially underground.

In these plants mainly as a consequence of the incentives previously mentioned for building the plants underground, advantage has been taken only of the additional level of containment given by the rock.

Exceptions are the gravity-fed water injection and spray system in the Chooz plant and the pressure relief system of the Lucens reactor cavern.

1.8.3. The operating experience of these underground plants has been satisfactory.

No significant incidents, besides the accident at the Lucens plant and a long outage at Chooz (between 1968 and 1970), have been reported and - what is very important - not one of the malfunctions (or the same accident at Lucens') have ever been caused by or related to the underground siting.

References

- 1-1 N. Hidle, O. Dahl
The Halden Boiling Heavy Water Reactor
Proceedings of the 2nd U.N. International Conference
on the peaceful uses of atomic energy
Geneva 1958 P/559
- 1-2 Halden BHWB
Nuclear Engineering, March 1959
- 1-3 N.G. Aamodt
Underground location of a Nuclear Reactor
Proceedings of the 2nd U.N. International Conference
on the peaceful uses of atomic energy
Geneva 1958 P/561
- 1-4 E. Jamne
Underground siting of nuclear power plants in Norway
Proceedings of the 4th International Conference
on the peaceful uses of atomic energy
Geneva 1971 P/290
- 1-5 R3/Adam - Combined heating and power project
Nuclear Engineering, May 1960
- 1-6 F.A. Abadie-Maumert
La Centrale thermo-électrique nucléaire suédoise
d'Agesta
Energie Nucléaire, Vol. 7, No. 6, 1965

- 1-7 L. Leine, A. Molin
The Agesta Reactor
Asea journal, 1964 Vol. 37, No. 5
- 1-8 L. Carlbon et al.
On the design and containment of nuclear power
stations contained in rock
Proceedings of the 2nd U.N. International Conference
on the peaceful uses of atomic energy
Geneva 1958 P/172
- 1-9 S.E.N.A. Centrale nucléaire des Ardennes
- 1-10 P. Erkes, P. Grau
La centrale des Ardennes: description et fonctionne-
ment
Energie Nucléaire Vol. 8, No. 8, 1966
- 1-11 The Ardennes station
Nuclear Engineering, Nov. 1961
- 1-12 Lucens: Switzerland's experimental pressure tube
reactor
Nuclear Engineering, Nov. 1962
- 1-13 E. Binggeli et al.
The underground containment of the Lucens experimental
nuclear power plant
Proceedings of the 3rd International Conference on
the peaceful uses of atomic energy
Geneva 1964 P/459

- 1-14 P. Kraft
The Lucens experimental nuclear power station
Proceedings of the 3rd International Conference
on the peaceful uses of atomic energy
Geneva 1964 P/692
- 1-15 Versuchsatomkraftwerk LUCENS
Bulletin des Schweizerischen Elektrotechnischen
Vereins
Bd. 53 (1962) No. 13
- 1-16 S. Pinto
A survey of underground nuclear power plants
Part. 1. The existing plants
TM-ST-491, July 1977

CHAPTER 2

THE HUMBOLDT BAY POWER PLANT UNIT No 3.

<u>Contents</u>	<u>Page</u>
2.1 Introduction	2-5
2.2 The Humboldt Bay Power Plant Unit No.3	2-6
2.3 Concluding remarks	2-14

2.1. INTRODUCTION

- 2.1.1. Before examining the main studies relative to the underground siting of nuclear power plants, a few words should be spent to describe a very peculiar existing plant, namely the unit No. 3 of the Humboldt Bay power station.

The plant, described hereafter, in reality cannot be defined as an underground plant (and for this reason it has not been described between the existing underground nuclear power plants) even if the reactor containment has been located below grade.

Infact, the physical arrangement of the plant is just a consequence of local conditions as the proximity to existing plant units and soil characteristics and not a consequence of a particular safety philosophy or considerations on the underground siting.

Another reason for this peculiar arrangement is the location of the fuel handling building above the reactor containment to provide an extra volume to collect any possible leakage from the reactor pressure suppression system.

- 2.1.2. The construction technique utilized to underground the reactor containment is very interesting and could be of some value for studies on the underground siting. This technique will be described in some detail in one of the following paragraphs.

2.2 THE HUMBOLDT BAY POWER PLANT UNIT NO. 3

- 2.2.1. The unit 3 of the Humboldt Bay power plant is a 65 MW(e) nuclear power plant utilizing a natural circulation direct cycle boiling water reactor (G.E. BWR 1).

The plant, which went into operation in 1963, is owned and operated by Pacific Gas and Electric Company and is located near Eureka, in northwestern California, USA. The reactor is located adjacent to an existing steam power plant consisting of the gas or oil fired conventional units 1 and 2, rated 50 MWe each.

The main feature of this plant (one of the first BWR with a pressure suppression containment) is that the reactor containment consists of a foundation caisson, sunk into the ground.

- 2.2.2. The reactor containment is located entirely below grade, under the fuel handling building (see Fig. 2 - 1), and consists of a reinforced concrete foundation caisson constructed in six lifts, four cylindrical and two rectangular.

The reactor drywell and pressure suppression chamber are located in the cylindrical portion of the caisson. The suppression chamber consists of a partial annulus of 300° around the drywell and is lined with welded steel plates. The remaining portion of the annulus houses an access shaft that connects the surface fuel handling building with equipment compartments and the bottom of the caisson.

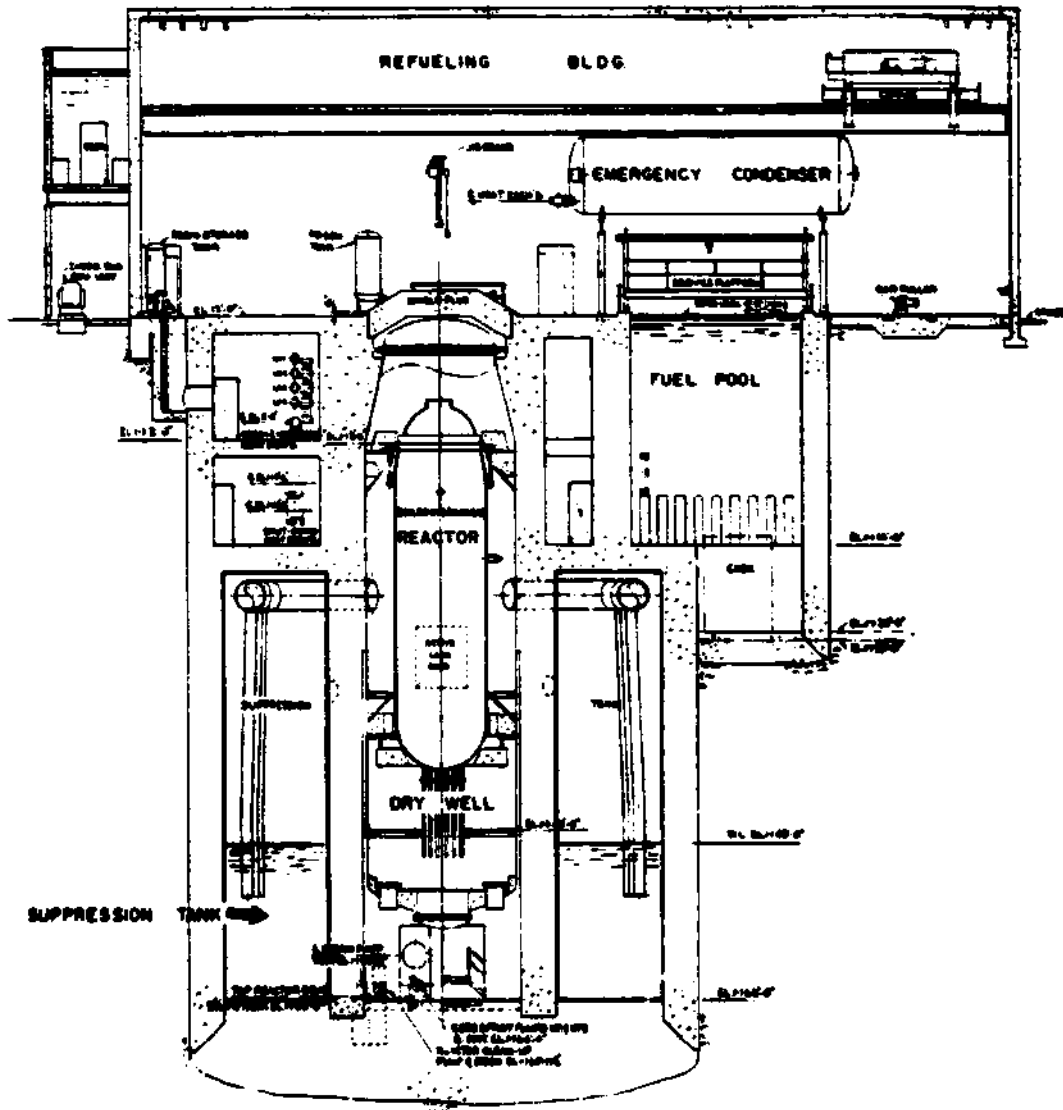

Fig. 2 - 1 Humboldt Bay Reactor containment (Section E-E)

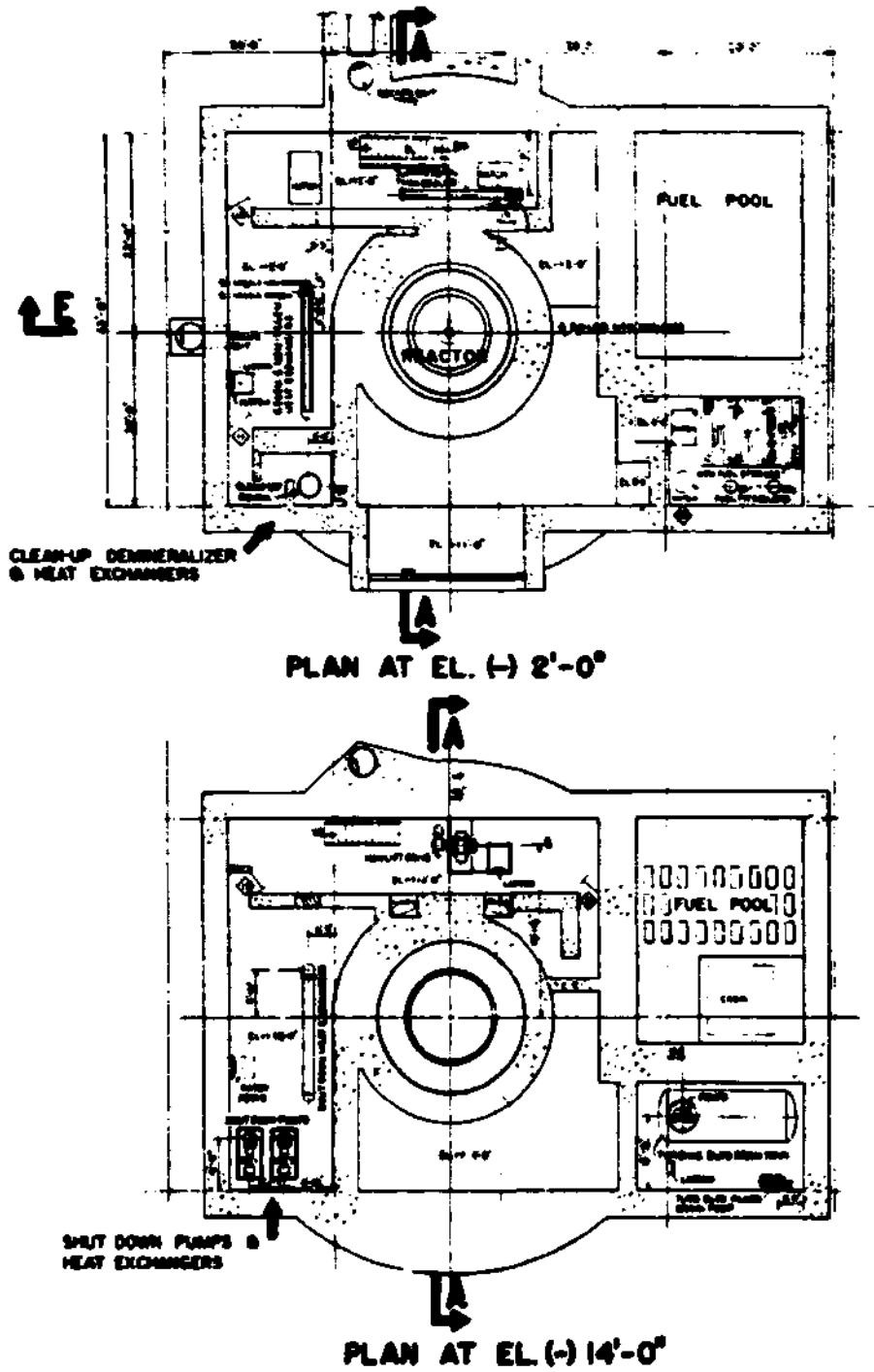

Fig. 2 - 2 Reactor Containment horizontal sections

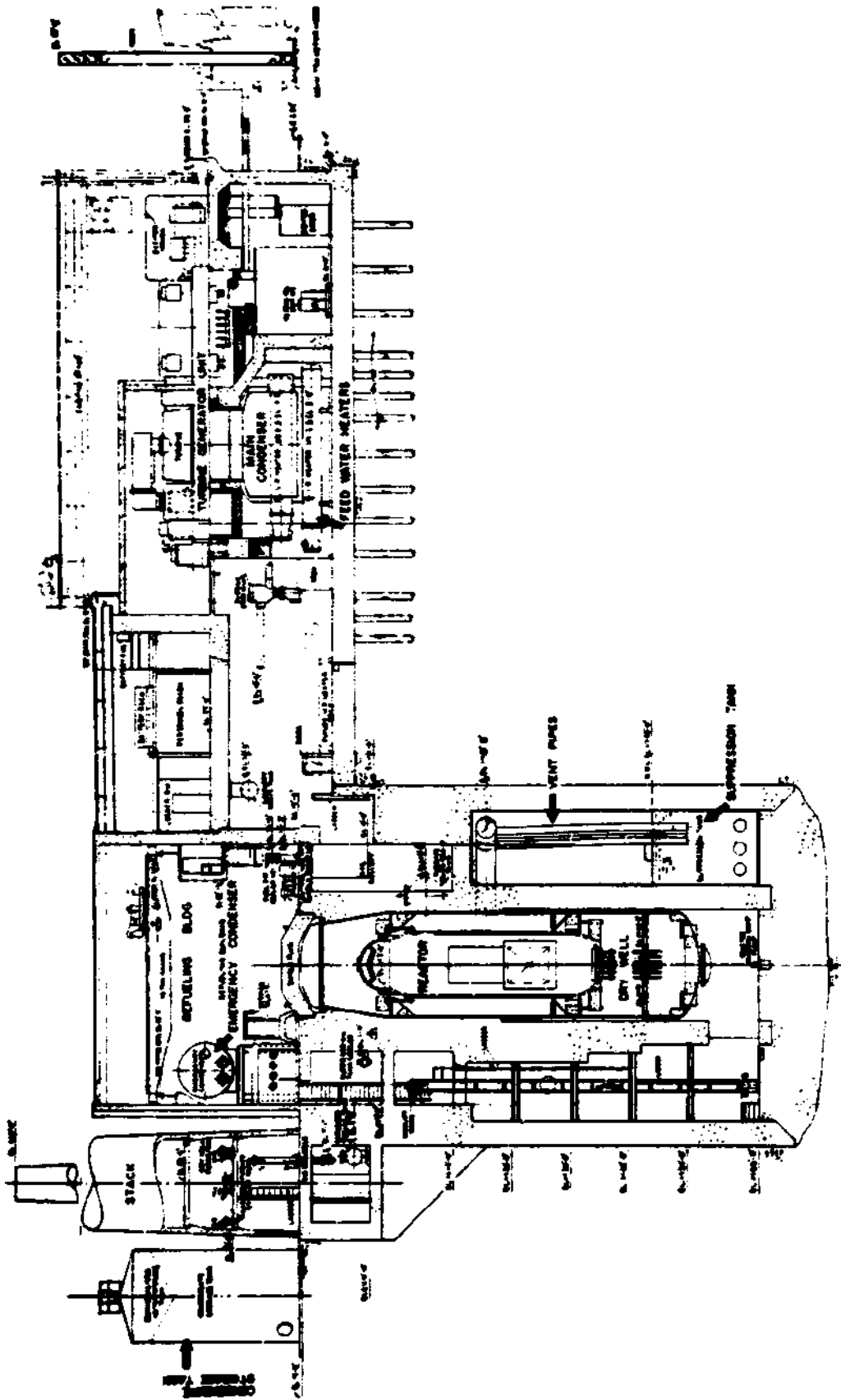

Fig. 2 - 3 Plant arrangement (Section A-A)

The rectangular portion of the caisson houses reactor auxiliary systems, the spent fuel pit and a new fuel storage vault. In addition, the rectangular portion supports a part of the fuel handling building and, in the same time, the 76 m high reinforced concrete ventilation stack.

2.2.3. The fuel handling building is a reinforced concrete structure located above grade and directly over the reactor drywell and spent fuel pit.

This building may be used in conjunction with the pressure suppression system to collect system leakages and to provide containment during refueling operations.

2.2.4. The arrangement of the Humboldt Bay unit 3 was, to a large extent, dictated by local conditions as the proximity of the reactor to the existing plant (about 10 m from the power house structure pile caps) and because of soil characteristics. (Ref. 2 - 1, 2 - 2)

The location of the containment below grade, however, takes advantage of "the inherent safety features provided by the shielding as well as the external pressure of the surrounding soil and water." (Ref. 2 - 1)

Siting the reactor containment below grade has also minimized the structural requirement for "overturning and shear in the event of an earthquake." (Ref. 2 - 1)

The plant, being located in a seismic area, has been designed to 0.25 g.

2.2.5. The soil in which the caisson has been sunk consists, after a layer of firm clay about 6 m thick, of sand and gravel with a layer, about 1.5 m thick, of sand and gravel with lenses and blocks of weakly cemented silty sand, about 10 m below grade.

2.2.6. The foundation caisson, as previously stated, consists of six lifts, four cylindrical and two rectangular.

The dimensions of the cylindrical portion of the caisson are 15.7 m height, 18.2 m O.D. and 15.7 m I.D. while the rectangular portion is 8.5 m high, 22.8 m long and 15.0 m wide.

The caisson was located underground with a sinking procedure, carried out after each lift.

A typical operations sequence was the following (Ref. 2 - 1):

- progressively sink the caisson so that the top of the caisson is at ground level.
- erect forms, reinforcing, conduits, pipes etc.
- pour concrete in approximately 4 - 4.5 m lifts.
- strip forms (usually a day later)
- apply a waterproof layer on the external walls
- sink the caisson by excavating and jetting water until top of concrete pour is again at ground level.

The excavation of the material from inside the caisson was accomplished by clamming with a bucket and jetting water.

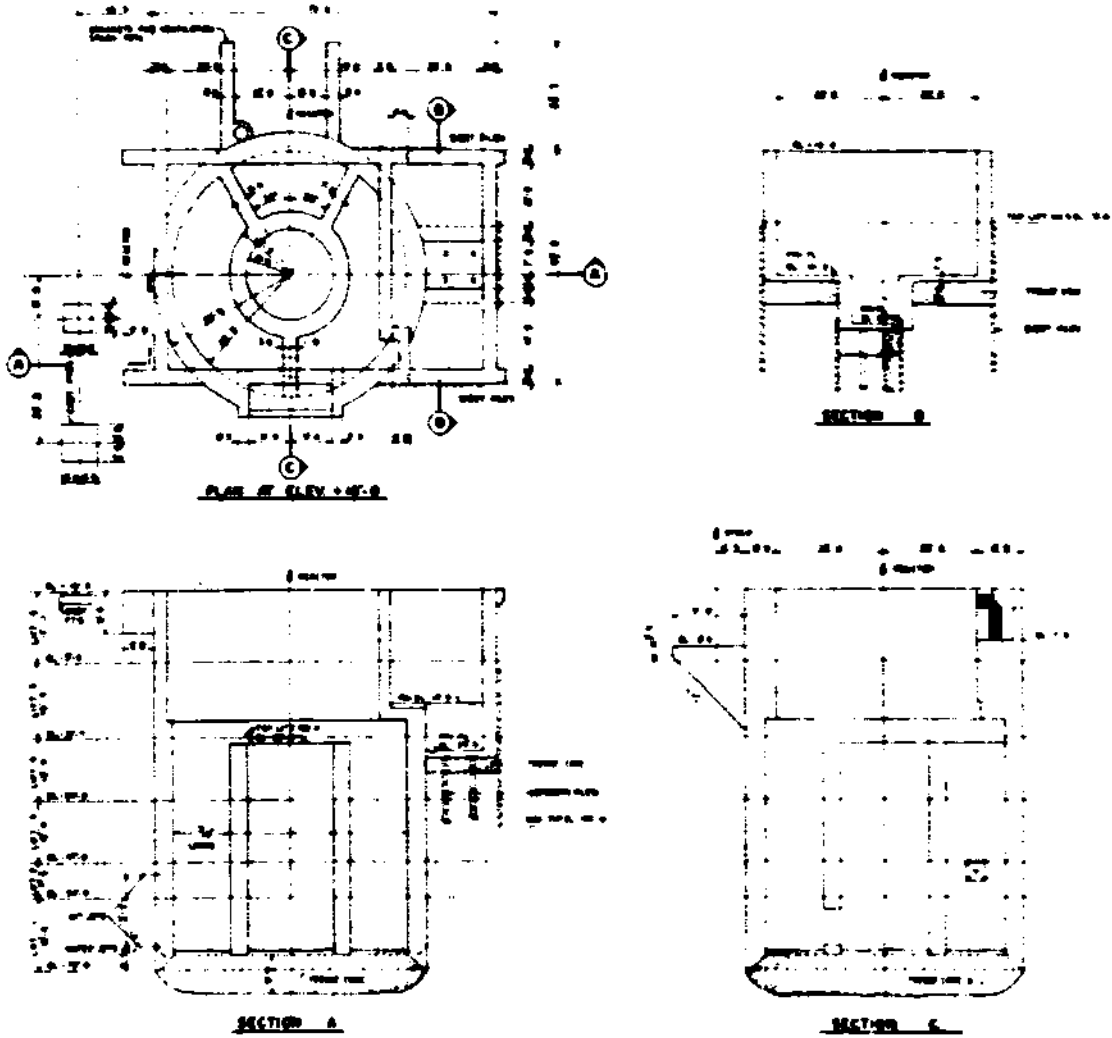

Fig. 2 - 4 Plan and cross section of reactor caisson

2.2.7. Because of the caisson proximity to the existing units, it has been necessary to install friction reducing devices to allow the caisson to sink without overexcavating.

For this purpose, several sets of lubricating water and compressed air jets were installed in the caisson walls.

The construction and the sinking of the caisson took about five months.

2.3. CONCLUDING REMARKS

2.3.1. The Humboldt Bay power plant unit 3, even if it cannot be considered as an underground nuclear power plant, has taken advantage of the underground location of the containment mainly for what concerns

- the shielding provided by the surrounding soil
- the external pressure of the soil and groundwater on the caisson
- the reduction of the seismic requirements for the underground structures.

Other potential advantages of this arrangement have not been taken into account since the motivations to locate the reactor containment below grade have been, besides the containment concept, mainly space availability and in situ soil characteristics.

2.3.2. The construction and sinking technique of the foundation caisson utilized as reactor containment is very interesting not only for the technique itself but also for what concerns the construction criteria.

Infact, the requirements for accuracy in placing the caisson and for plumbness were very severe.

However, in spite of the soil characteristics and of the unusual and complicated shape, drifting and tilting of the caisson have been kept within the fixed tolerance limits.

References

- 2-1 H.W. Wahl
Foundation caisson provides underground containment
for nuclear power plant
Nuclear Engineering and Design 3 (1966)
- 2-2 C.P. Ashworth et. al.
Pressure Suppression
Nuclear Engineering International Aug. 1962

CHAPTER 3

THE EARLY STUDIES

<u>Contents</u>	<u>Page</u>
3.1 Introduction	3-5
3.2 The Energie Nucléaire S.A. project	3-7
3.3 The USAEC Study	3-14
3.4 The P3 project	3-19
3.5 The ADAM project	3-21
3.6 The Sulzer project	3-26
3.7 The experimental nuclear reactor AARE	3-33
3.8 Comparison among the studies	3-40
3.9 The motivations	3-42
3.10 Concluding remarks	3-44

3.1. INTRODUCTION

3.1.1. During the late fifties, in the same period of time as the construction of some of the existing underground nuclear plants, a few studies on the underground siting were carried out in various countries, in Europe and in USA.

In Europe, the majority of these early studies on the underground siting was aimed at achieving a safety level higher than that considered possible for a surface plant, mainly because of the feeling of insecurity and inadequacy of the knowledge of the nuclear phenomena that, at that time, was common in the nuclear field.

Also the very high population density, typical of many European countries, played a big role in the decision to investigate the feasibility of the underground siting and, eventually, to build some nuclear plants underground.

At the same time, in USA, some general studies were performed on the subject.

The main motivation of these studies was plant protection against enemy nuclear attack (Ref. 3 - 1).

The increasing interest on this type of siting eventually led the USAEC to make in 1957 a more detailed study on the underground siting, (Ref. 3 - 4).

This study, that will be described hereafter in some detail, is the first study aimed at assessing, besides the protection against a nuclear attack, advantages, disadvantages and costs of the underground siting.

3.1.2. Some of these early studies are described in the following paragraphs.

In this description, importance has been given mainly to plant layout characteristics, plant safety features and plant peculiarities.

The main motivations and the main results of the studies are given.

3.2. THE ENERGIE NUCLEAIRE S.A. PROJECT

3.2.1. Energie Nucléaire S.A., a Swiss company groundend in 1957, which participated to the design and construction of the Lucens nuclear power plant, designed in 1957 a small experimental nuclear plant partially located underground (Ref. 3-2, 3 - 3).

The main purpose of this company was to build this experimental facility in french-speaking Switzerland to train the personnel needed for building, and then operating, large size nuclear power plants. The plant was also ment as a training facility for students in the nuclear field.

The chosen reactor was an indirect cycle boiling water reactor with slightly enriched uranium oxide as a fuel and light water as moderator and coolant.

For experimental purposes, a bypass to send the steam from the reactor directly to the turbine was also provided for.

3.2.2 The underground portion of the plant, in a hillside, consists mainly of a rock cavity 57 m long, 10 m wide and 32.5 m high.

This cavern, designed to withstand an overpressure of 2 kg/cm^2 , is divided in two separate halls by a leaktight wall: the reactor hall housing the reactor and the primary and secondary loop including the turbogroup, and the auxiliary system hall.

Access to the cavern, which is gastight, is through airlocks located in the branches of the in tunnel (Fig. 3 - 2).

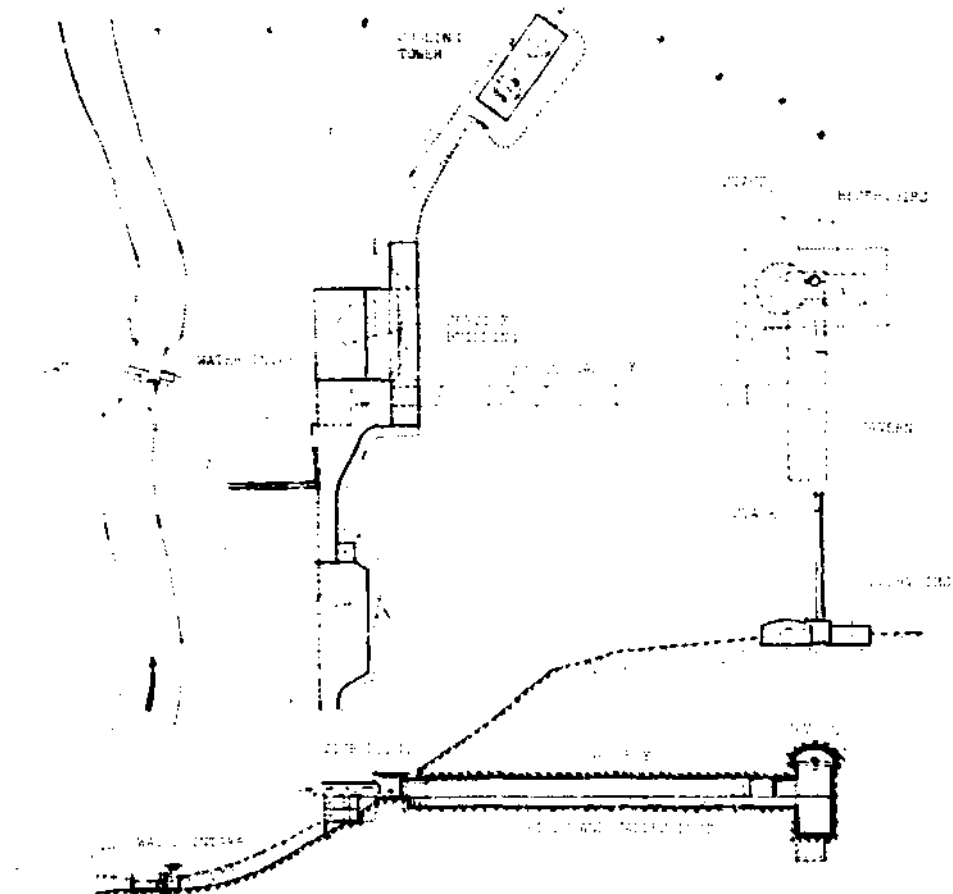

Fig. 3 - 1 Energie Nucléaire S.A. project: site plan

Connection to the surface is through a two floor tunnel, about 90 m long. The upper part is for personnel and equipment passage, the lower part for cables and piping. An emergency access to the auxiliary systems hall is provided through the ventilation stack.

Both halls have an independent closed loop ventilation system to control possible radioactive releases in case of accidents. In the reactor hall, supposed unmanned during

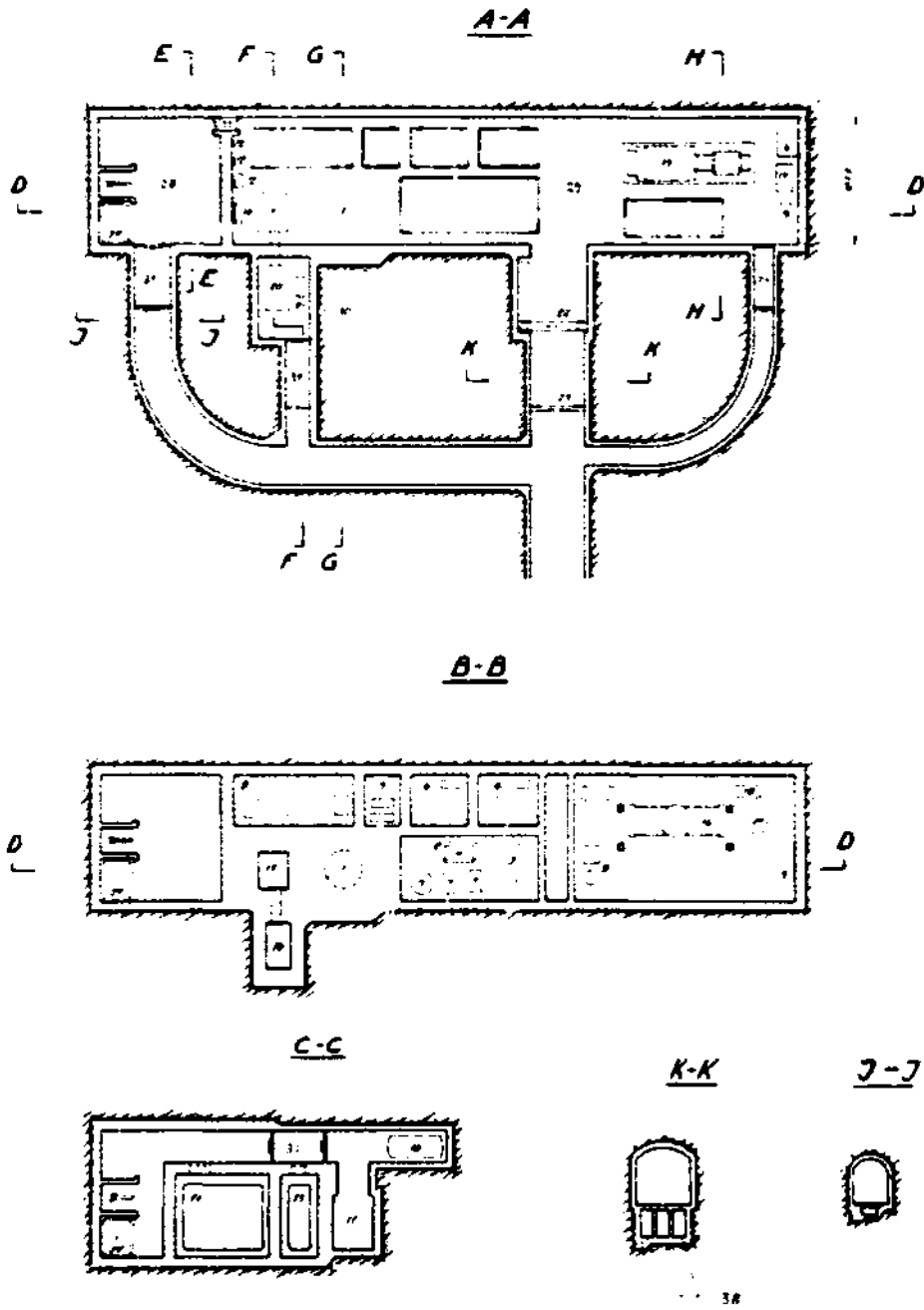

Fig. 3 - 2 Energie Nucléaire S.A. project: plant sections

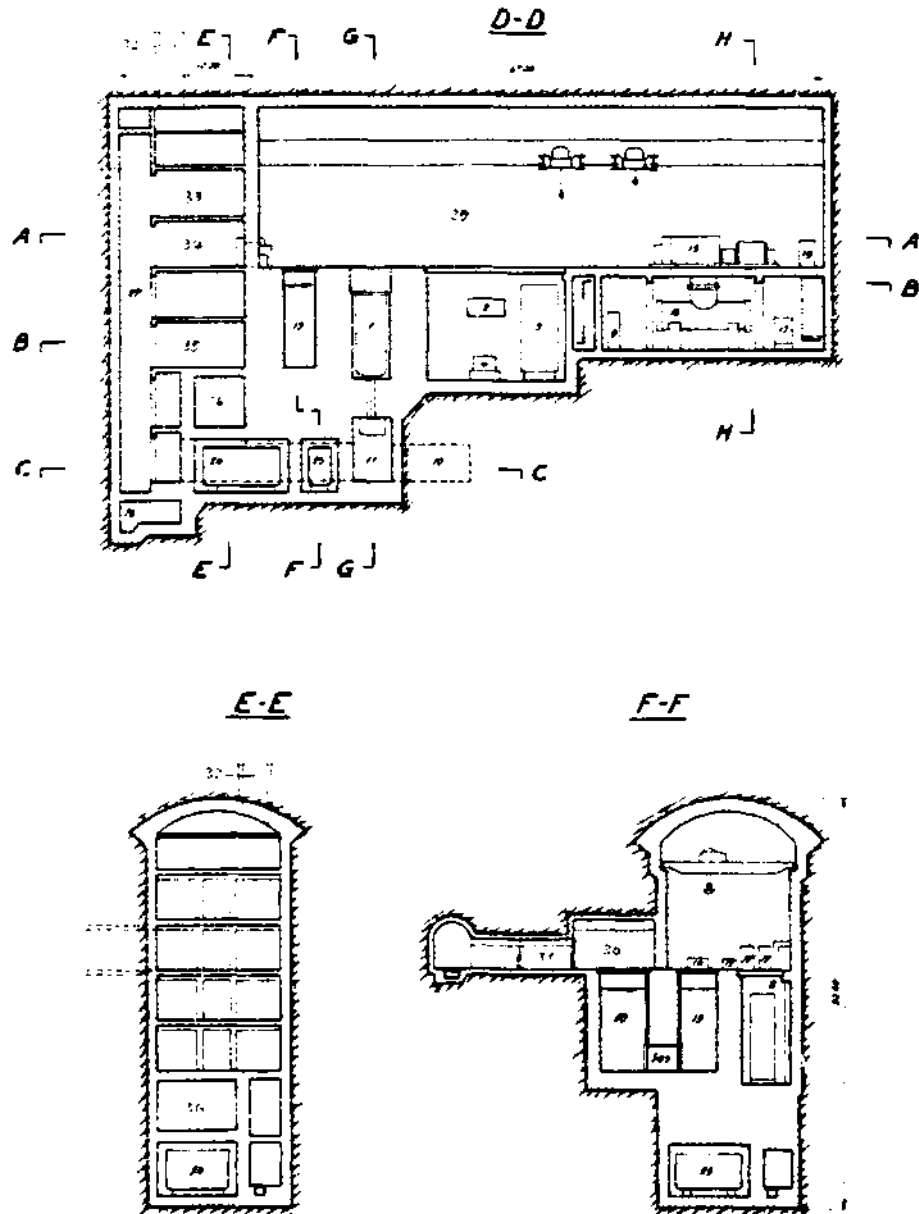

Fig. 3 - 3 Energie Nucléaire S.A. project: plant sections

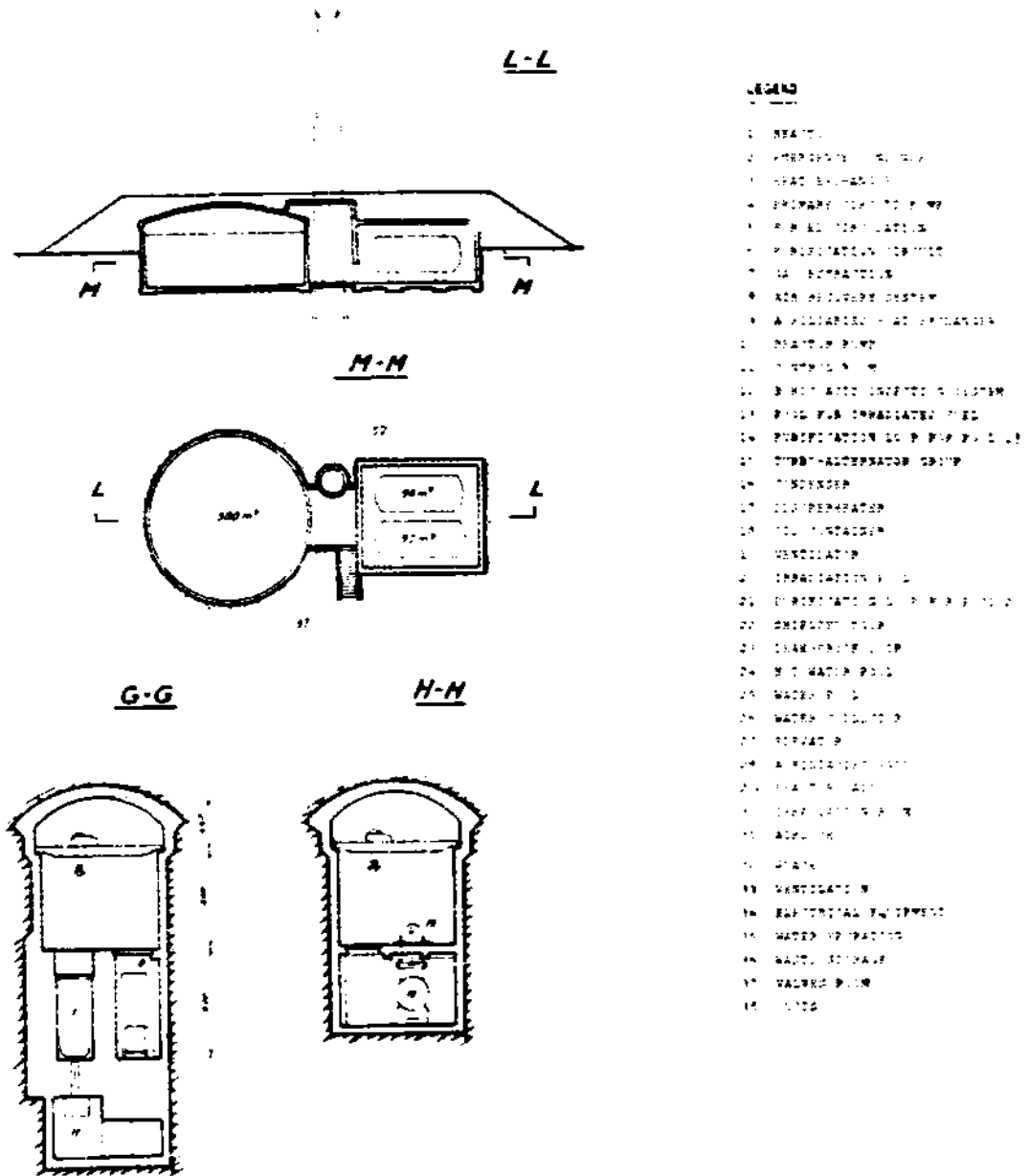

Fig. 3 - 4 Energie Nucléaire S.A. project: plant sections

reactor operation, there is an automatic emergency water spray system to quench the steam pressure in case of an accident. This system is gravity-fed by the water (500 m³) contained in reservoirs located above-ground.

An irradiation area for research and tests is provided for near the reactor hall.

3.2.3. The control room, the transformer and coupling station, the offices and the administrative area and laboratories are housed in a service building on the surface.

A stack for the ventilation of the cavern, together with water reservoirs is located on the hill housing the plant. A water intake and a cooling tower are the other plant facilities located on the surface.

3.2.4. The reasons that lead to design this plant underground are the following:

- a rock cavity plant offers greater safety in the unlikely case of a major accident
- an underground plant is better protected against acts of war
- the use of a cavern as a reactor containment has definite advantages from the psychological point of view of the general public
- in Switzerland, a rock containment should not be more expensive than a surface containment

3.2.5. The civil engineering work costs, including service building and cooling tower have been estimated in this study to be about 30 % of the total plant costs.

3.3 THE USAEC STUDY

3.3.1. The aim of this study was to outline and evaluate advantages, disadvantages and costs of an underground reactor construction as compared with an above ground plant and to determine site requirements for selected types of reactors to be built underground in rock formations (Ref. 3 - 4).

Another task of this study was to determine design requirements for the protection against nuclear attack, such as depth of burial, blast resistant doors, protected ventilation equipment etc. The results of this last investigation however have not been published having been considered classified information.

The study is based on the EBWR, an experimental direct-cycle boiling water reactor, rated at 5 MW(e).

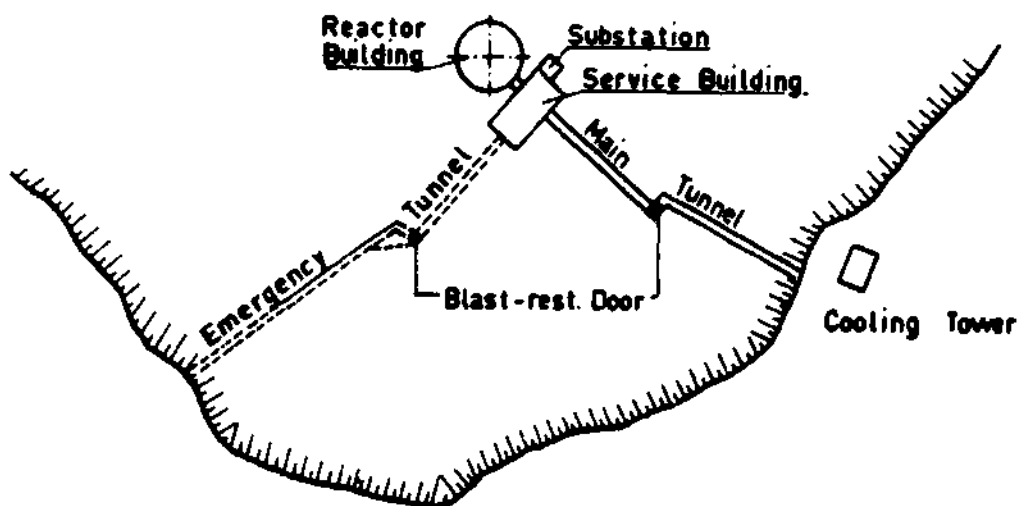

Fig. 3 - 5 USAEC study: site plan

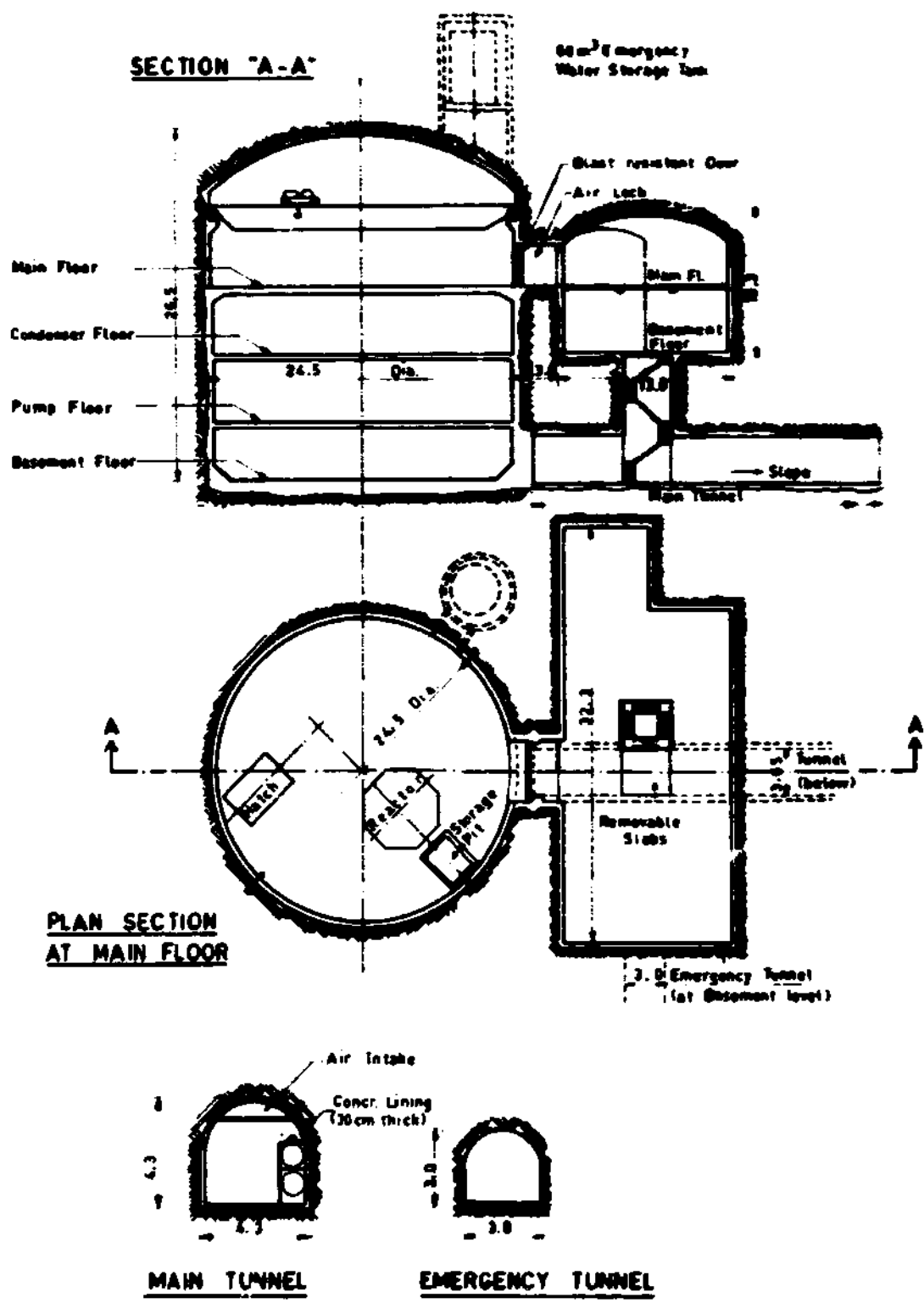

Fig. 3 - 6 USAEC Study: plant sections

1.3.2. The underground plant, in a hillside, is mainly based on the above ground layout and consists of a cylindrical cavern with a domed roof housing the reactor and of a cavern, rectangular in shape with an arched roof, housing the service building.

The dimensions of the reactor cavern are about 24.5 m diameter and 26.5 m maximum height. The dimensions of the service building cavern are 32.3 m maximum length, about 14 m width and 10.3 m maximum height.

An alternative scheme with a rectangular shaped reactor cavern with an arched roof has also been proposed to have a shorter cavern span: the dimensions of this cavern are 35 m length and about 14 m width.

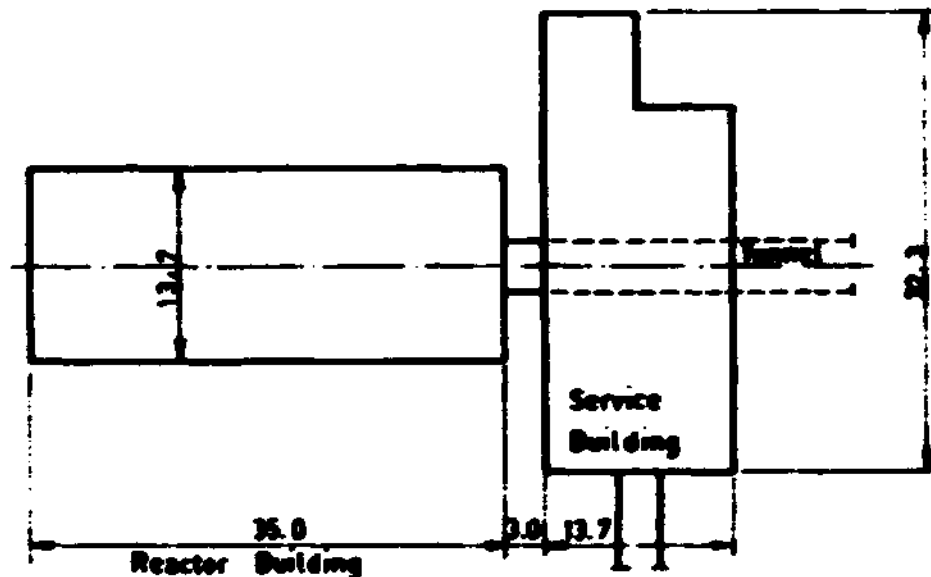

Fig. 3 - 7 USAEC study: alternative plant layout

3.3.3. The reactor cavern houses the reactor, the spent fuel storage pit, the steam power plant and related auxiliaries. The service building houses the main control room, electrical equipment room, laboratories, offices etc. A water storage tank, containing about 60 m³ of water for the spray system, is located in an excavated space to one side of the reactor cavern dome. A cooling tower is located above ground.

Access to the plant is by means of a main tunnel about 150 m long running into the reactor cavern at the base mat level and by means of an emergency tunnel about 210 m long running into the service cavern at the basement floor level. Blast resistant doors are provided for in the tunnels.

Caverns and tunnels are lined with concrete: in the reactor cavern a steel liner is also provided for to avoid contaminated seepage into the rock.

A minimum rock overburden of 15 m is considered sufficient to provide containment in case of major accidents and protection against "near surface explosions of large thermo-nuclear weapons". (Ref. 3 - 4)

3.3.4. According to this study the advantages of an underground nuclear plant, as compared with a surface plant, are the following:

- superior protection against acts of war (nuclear weapons included)
- effective containment of radioactivity in case of

extreme accidents with the possibility of eliminating the conventional containment building

- immunity to surface phenomena
- relative invulnerability to earthquake shocks.

The main disadvantages of the underground siting have been identified as follows:

- difficulty in determining in advance the exact conditions of the rock structure
- limited flexibility with respect to access and expansion
- slight chance of contaminating the groundwater following a major accident
- increased construction costs.

3.3.5. The increased cost for the underground siting has been estimated to be between 3 and 7 % of the total cost of the plant.

However, the economy of the underground construction improves with the increasing size of the plant.

3.4. THE R3 PROJECT

3.4.1. The R3 project, started in 1955, had two main aims: the realization of a prototype of a commercially interesting district heating plant and the realization of a small scale nuclear power plant to gain some experience for the construction and operation of large units (Ref. 3 - 6).

The chosen concept utilized a natural uranium heavy water reactor for the combined production of electricity and heat for district heating purposes.

This plant was to be built in Ågesta, about 3.5 km from Farsta, a Stockholm suburb.

In 1958, because of economical reasons, this project was combined with the Adam project (described in the next paragraph) leading then to the realization of the R3/Adam or Ågesta reactor.

3.4.3. The plant was designed partially underground in a hillside. The layout of the plant is, with the exceptions of minor differences, very similar to that of the Ågesta reactor. For this reason, a detailed description of the plant, represented in the next figure, is not given.

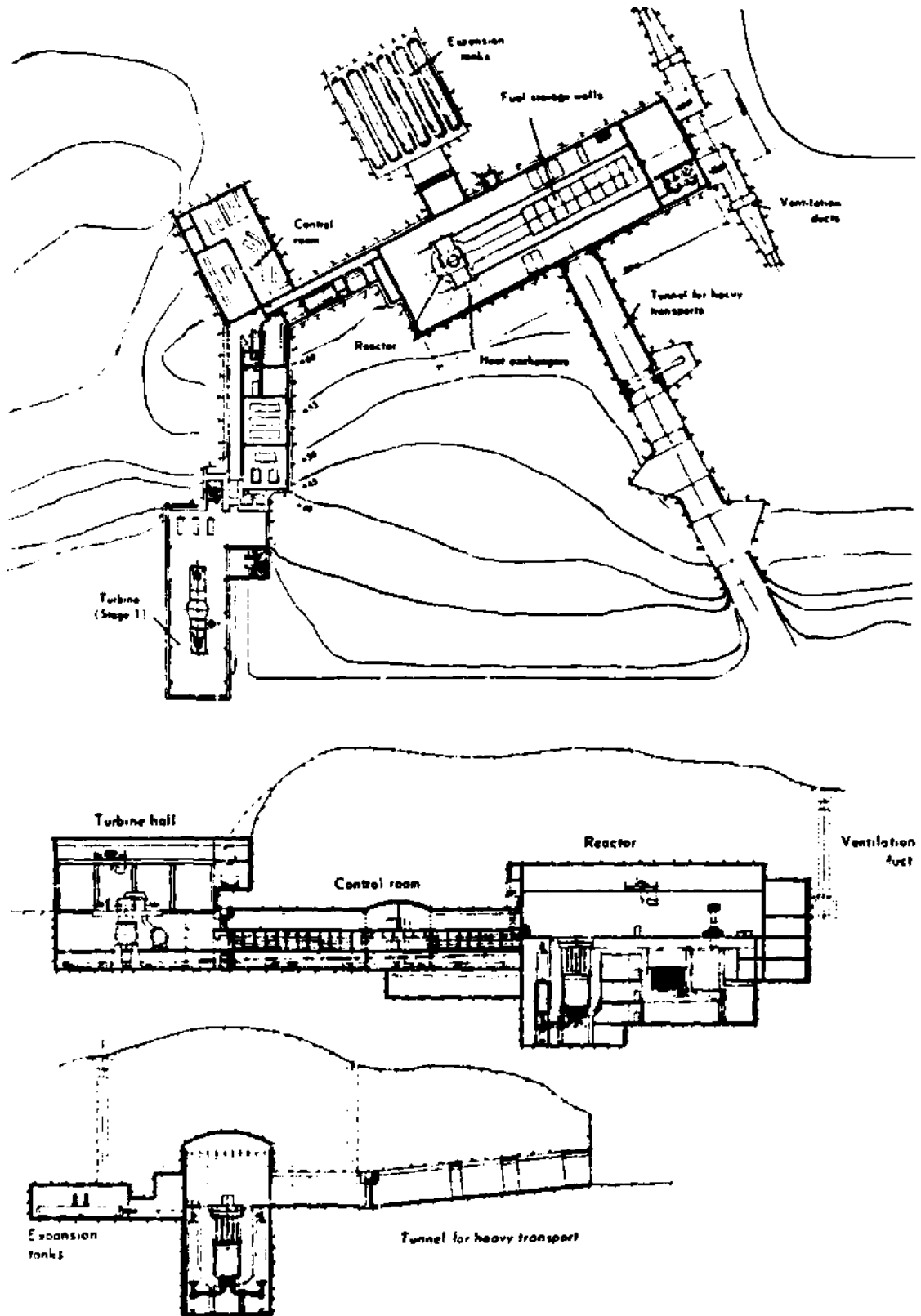

Fig. 3 - 8 R3 project: plant sections

3.5. THE ADAM PROJECT

3.5.1. Adam was a 75 MW nuclear reactor meant to produce heat for district heating purposes and was planned to be located in Västerås, a town 120 km west of Stockholm, Sweden (Ref. 3 - 5). In 1958, however, this project was combined with the R3 project giving then origin to the Ågesta nuclear power plant or R3/Ågam.

The reactor was designed to use natural uranium in dioxide form as fuel and heavy water as moderator, reflector and coolant.

The reactor hall, the operation building and the transformer room were planned to be in rock, deep below the surface, while administration and storage facilities were planned to be in a building above grade.

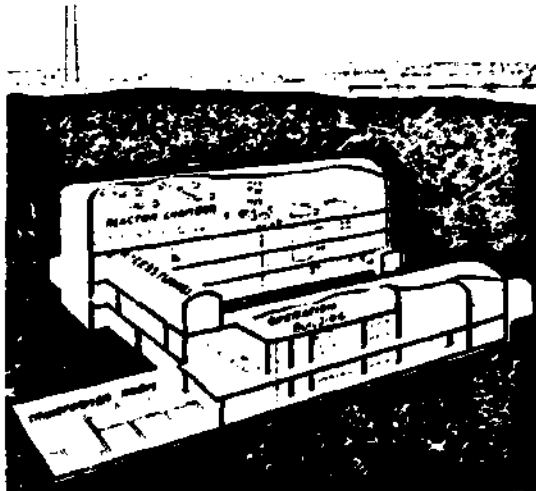

Fig. 3 - 9 Outline drawing of the ADAM reactor

3.5.2. The reactor hall is a rectangular cavern with an arched roof divided in four main floors.

Heat exchangers, some reactor auxiliary equipment, two spent fuel pits, a new fuel elements storage vault, ventilation equipment, fuel handling facilities, active waste areas etc. are located in this cavern.

All areas are accessible through personnel corridors that can be entered also during reactor operation. The reactor hall, however, is not supposed to be entered during plant operation at the operating floor.

The reactor cavern is lined with concrete applied directly to the rock to resist internal pressure while the gas-tightness requirements are met with welded steel plates.

3.5.3. The operation building is a rectangular cavern separated from the reactor hall by about 30 m of rock and from the transformer room by the access tunnel.

The cavern is divided in two floors. The upper floor contains the control room, the pumps for the district heating system, the auxiliary systems cooling equipment and the reactor emergency cooling system.

The transformer room or electrical building is at the same level of the operation building, on the other side of the access tunnel.

The building is divided in three floors and houses transformers, stand-by diesels, accumulators etc.

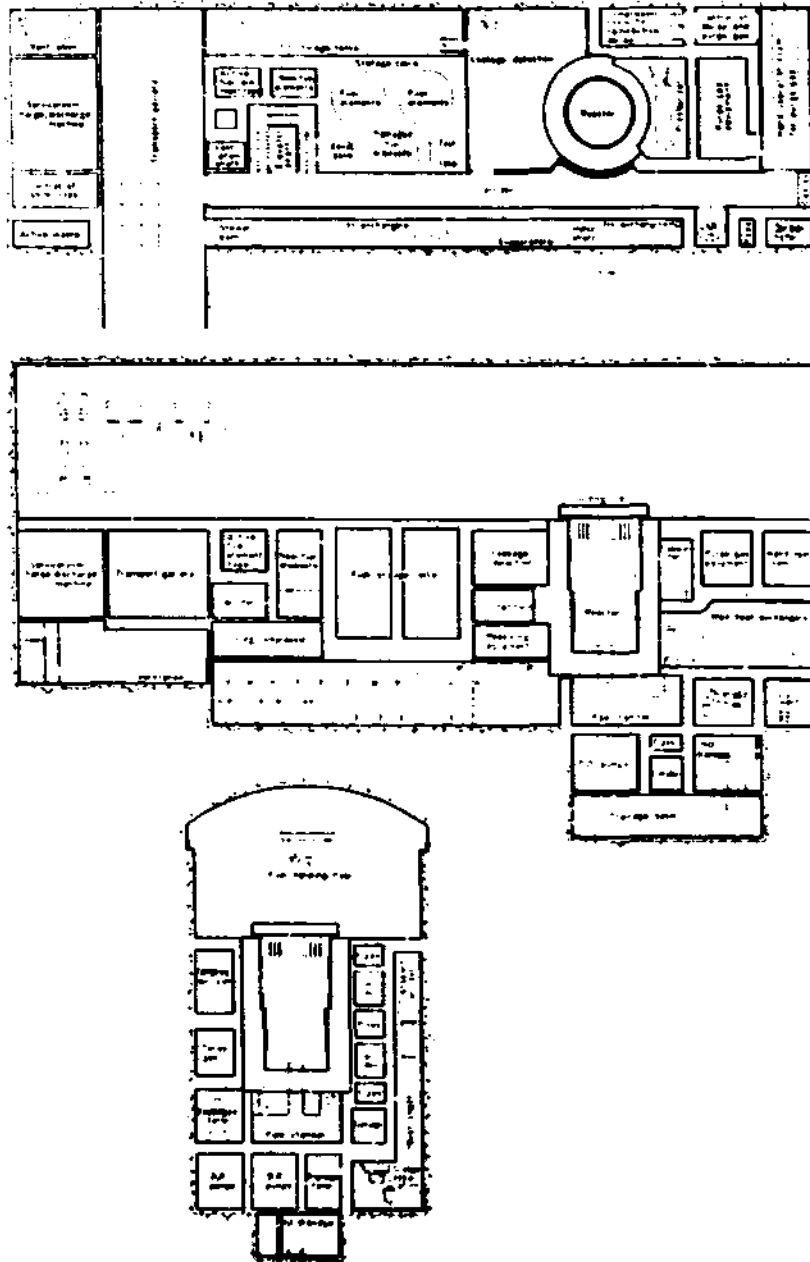

Fig. 3 - 10 ADAM project: reactor cavern sections

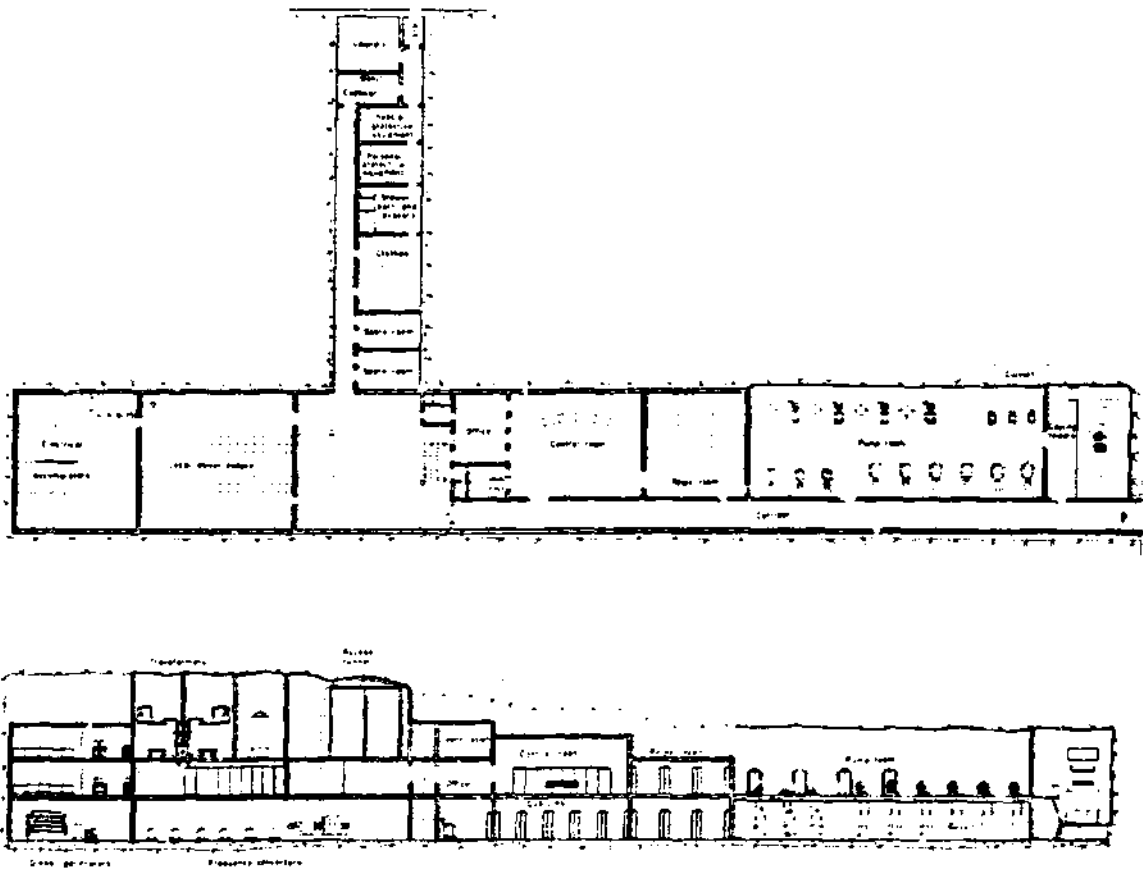

Fig. 3 - 11 ADAM project: operation building sections

3.5.4. Connections to the surface are by means of two tunnels (one for access and the other for ventilation) and by means of an elevator for personnel and light equipment.

The access tunnel, equipped with airlocks, connects the reactor hall to the surface through the operation building. This tunnel consists of three floors. The upper floor is utilized for equipment transportation, the second floor is a passage for personnel and the lowest is for cables and piping and some electrical equipment.

Another tunnel, however, connects the reactor hall to the operation building. This tunnel, where some cables and piping run, is equipped with an airlock and can be utilized as an emergency exit from the reactor hall.

The hot water pipes to the district heating system and cables to the surface pass through the elevator shaft.

- 3.5.5. The main reason that lead to design this plant underground was "to eliminate as far as possible the risks to the surrounding population in connection with a reactor accident" (Ref. 3 - 5).

In this perspective, special measures have been planned to prevent also groundwater contamination following an accident with cavern lining damages, lowering the groundwater level below the bottom of the plant caverns.

3.6. THE SULZER PROJECT

3.6.1. In the years between 1956 and 1958, Sulzer Bros. Ltd, together with a group of major swiss industries, made a study on an underground nuclear plant for the production of electricity and of heat for the existing district heating system (FHK) of the Swiss Federal Institute of Technology in Zürich (Ref. 3 - 7, 3 - 8).

The reactor was a pressure tube type, heavy water cooled and moderated, using natural uranium as fuel (with a small number of fuel elements, however, with uranium enriched to 1%) rated 30 MW(th).

The plant should have been located in two underground rock chambers within the town of Zürich (Fig. 3 - 12): the water cooling system should have been using the water from the river Limmat.

3.6.2. The reactor, the primary heat exchangers and the reactor auxiliaries are located in a cylindrical cavern with hemispherical ends, 40 m high and 20 m in diameter.

In the upper part of the reactor cavern there is a room in which all heavy systems, some of the reactor auxiliary systems and the fuel handling machine are located. This room, because of the radioactivity level of the coolant, is not accessible during plant operation.

The lower part of the reactor cavern, however, can be entered any time and is separated from the upper part by a thick shielding concrete floor. The lower part is divided in three

stories and contains the spent and new fuel storage systems, the water purification systems (both for light and heavy water), ventilation and electrical systems etc. In the basement, a large water tank has been provided for to collect, besides the small amount of water that could be lost during normal operation, the large quantities of water necessary to condense the steam and to wash the cavern walls in case of a major accident.

The water for the emergency spray system is stored in a large tank under the roof of the cavern.

The reactor cavern is lined, to provide gastightness, with a thin steel shell (6 mm thick) on concrete grouting poured against the rock walls.

A blast shield, made of concrete, inside the steel shell, protects the walls from missiles.

The reactor cavern is connected to the turbine hall through a tunnel of circular cross section, 23 m long and 7 m diameter, lined with steel plates for leaktightness and equipped with airlocks.

3.6.3. The turbine cavern (rectangular in shape with an arched roof, 12 m wide, 12.5 m high and 60 m long) houses two steam turbines and auxiliaries, the steam transformers and other equipment for the district heating system, the electrical power supply and distribution systems, the control room etc.

This cavern, lined with concrete, is connected to the surface through a material and a personnel elevator shaft (that house also steam accumulators, piping, cables and ven-

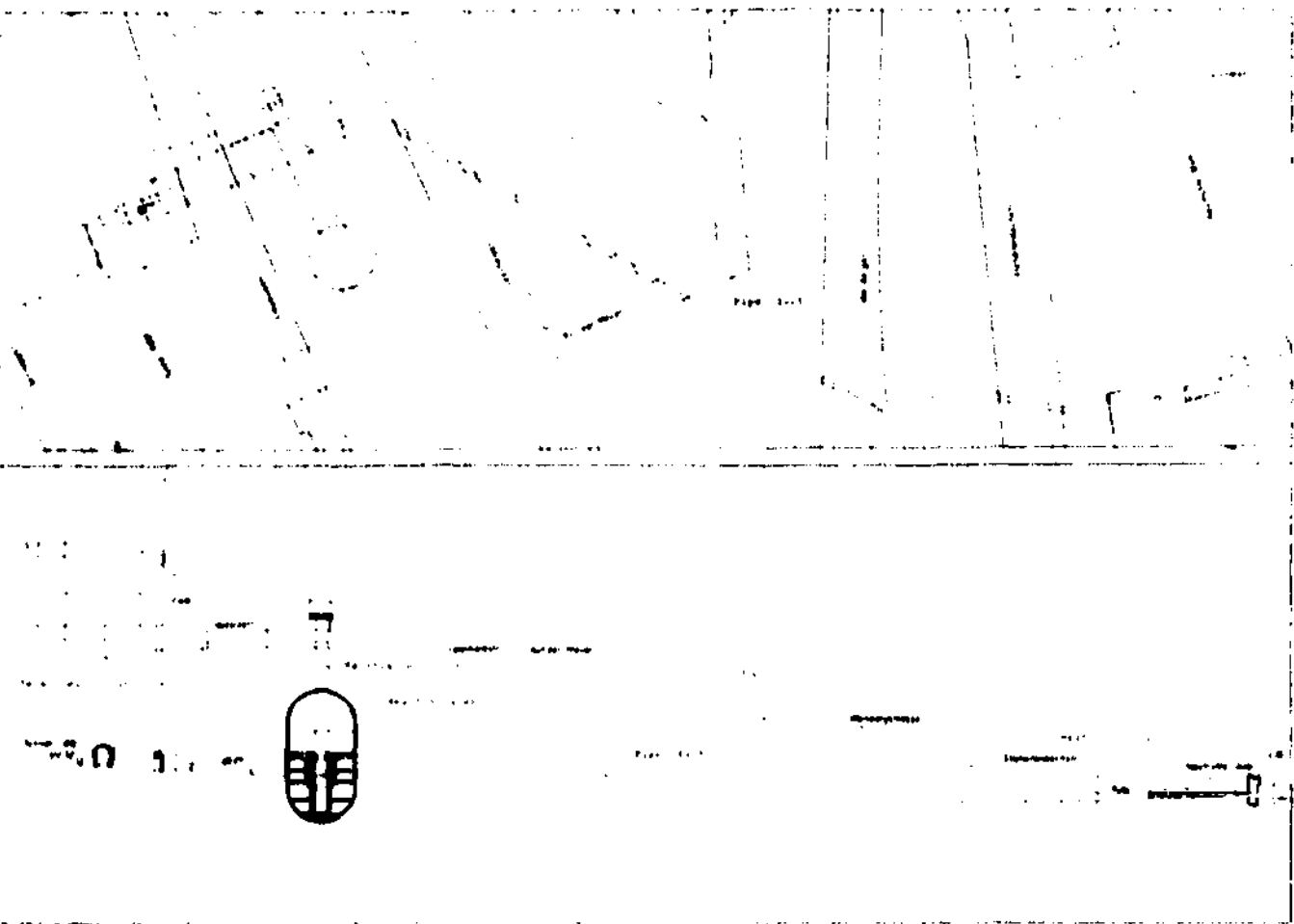

Fig. 3 - 12 Sulzer project: site plan

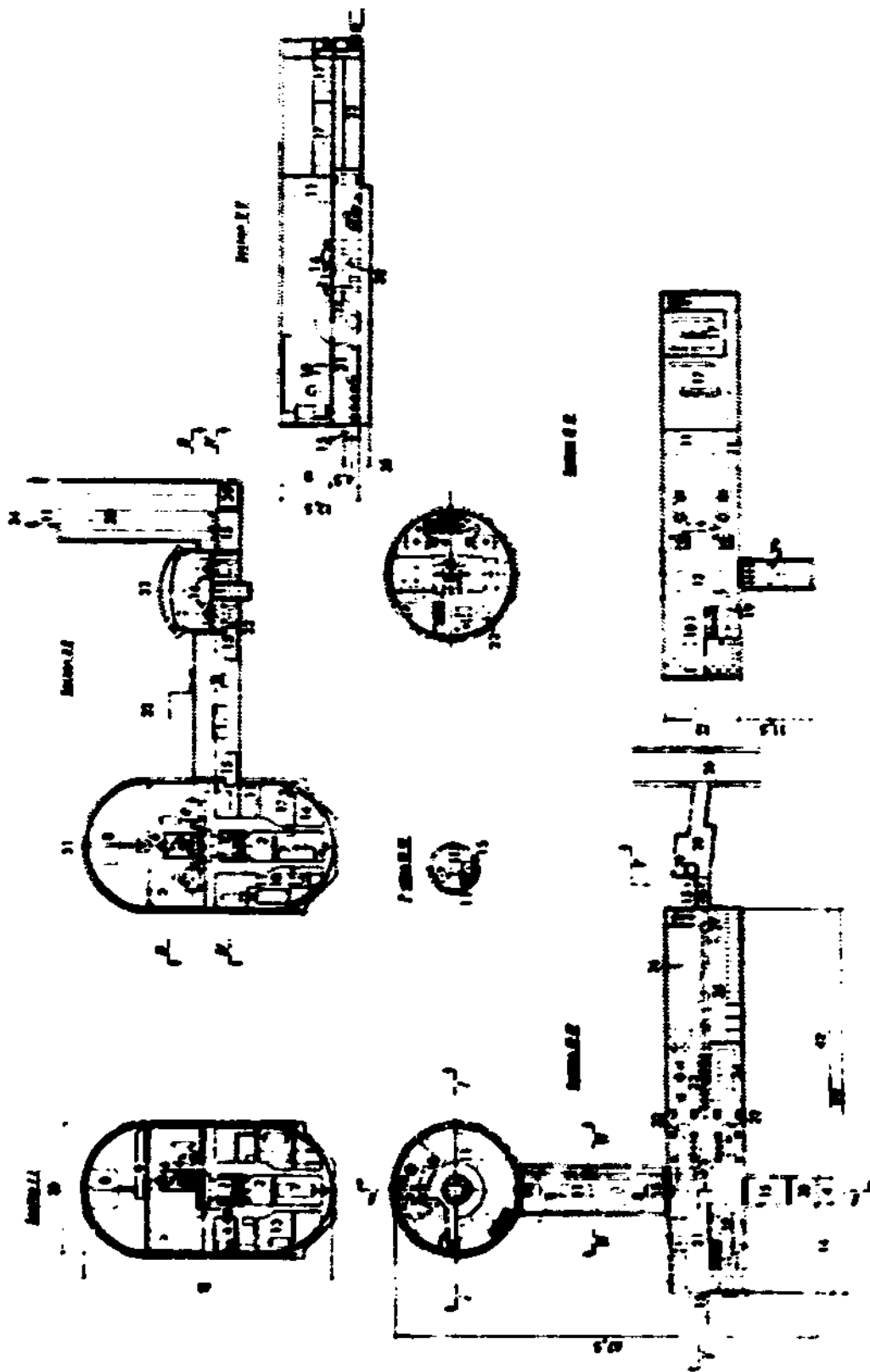

Fig. 7 - 13 Sulzer project: plant sections

1. motor, 2. expansion space, 3. heat exchanger, 4. steam generators and D.O pumps, 5. moderator cooling system, 6. fuel changing machine, 7. D.O storage tank, 8. emergency water storage tank, 9. crane, 10. fuel element storage, 11. ventilator plant, 12. access opening, 13. D.O and H₂O purification system, 14. water reservoir, 15. air locks, 16. steam turbines, 17. control room, 18. feed water tank, 19. steam transformer, 20. steam accumulator, 21. cooler for intermediate circuit, 22. steam condenser, 23. emergency power diesel, 24. electrical converter groups, 25. transformers and high tension switchgear, 26. electrical distribution system, 27. batteries, 28. existing tunnel, 29. personnel elevator, 30. feed conveyor, 31. reactor chamber, 32. communicating tunnel, 33. machine chamber, 34. elevator shaft, 35. conduit tunnel, 36. railway tunnel

tilation ducts), through a duct to the pumping station located on the right bank of the river Limmat and through a tunnel to an underground railway line (tunnel SBB). All these tunnels and ducts are equipped with airlocks.

3.6.4. Since this plant was planned to be in a densely populated area because of the existing district heating net and therefore isolation of the plant with safety distance was not possible, a meticulous containment system was designed.

The containment principle is based on the control of possible radioactive leakages in case of a major accident. This control is achieved, ensuring that any leakage is inwards, into the plant, by means of a ventilation system that maintains the pressure in the underground cavern below atmospheric.

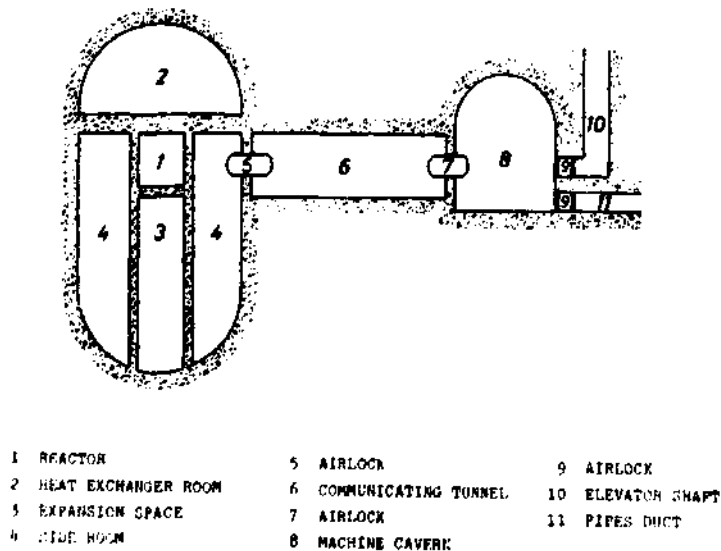

Fig. 14 Sulzer project: containment system

In the turbine cavern there is an open ventilation system working on the suction principle ensuring automatically an underpressure whatever the outside pressure is. The ventilation of the reactor cavern instead, to comply with the containment principle, is ensured by a closed loop system. A system for air supply and exhaust, but precluding any direct communication between this cavern and the free atmosphere, is also provided for.

In the tunnel connecting the reactor cavern with the turbine hall, lined with steel and equipped with airlocks at both ends, the pressure is maintained at a higher level than in the caverns. In that way any unchecked leakage from the reactor cavern to the environment is impossible.

In case of an accident with an increase of pressure in the reactor cavern, there will be some leakage through the penetrations into the airlock, in the connecting tunnel.

In that case, while reducing the overpressure in the reactor cavern, by means for instance of the emergency spray system, the pressure in the tunnel can be increased pumping fresh air into it.

The contaminated air is then trapped in the airlock and can be exhausted through a stack, under controlled conditions, after being passed through a filtration system.

6.5. In this study, the potential advantages of the underground siting, mainly safety related, are considered to be:

- the additional radiation protection provided by the rock

- a higher protection against missiles damages
- the leaktightness more easily achieved in an underground construction than above ground
- a better protection against acts of war

6.6. A cost estimate shows that the underground construction is not more expensive than "a comparable containment enclosure above ground" (Ref. 3 - 8).

It should be noted that, for this project, another site was proposed late in 1958. The new location was near the site chosen by Suisatom AG for the experimental reactor Aare, (described in the next paragraph) in Villigen (Switzerland) (Ref. 3 - 9).

3.7. THE EXPERIMENTAL NUCLEAR REACTOR AARE

3.7.1. Suisatom AG, a company grounded in 1957 by some of the main swiss utilities (ATEL, BKW, NOK, EOS), designed in 1958 an experimental nuclear power plant partially located underground (Ref. 3 - 10, 3 - 11).

The main motivations for the construction of this experimental plant were to train personnel for the construction and the exploitation of large nuclear power plants and to gain some useful experience (for instance, for what concerns the caverns tightness, the personnel and plant safety, the waste handling and storage systems etc) from the construction and the operation of the plant.

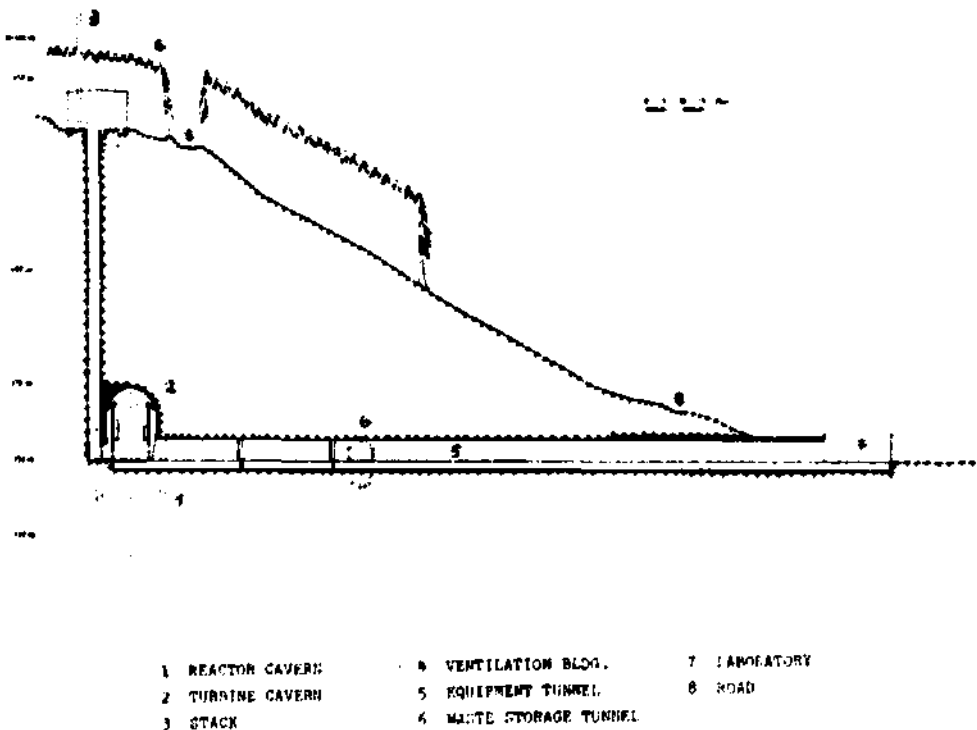
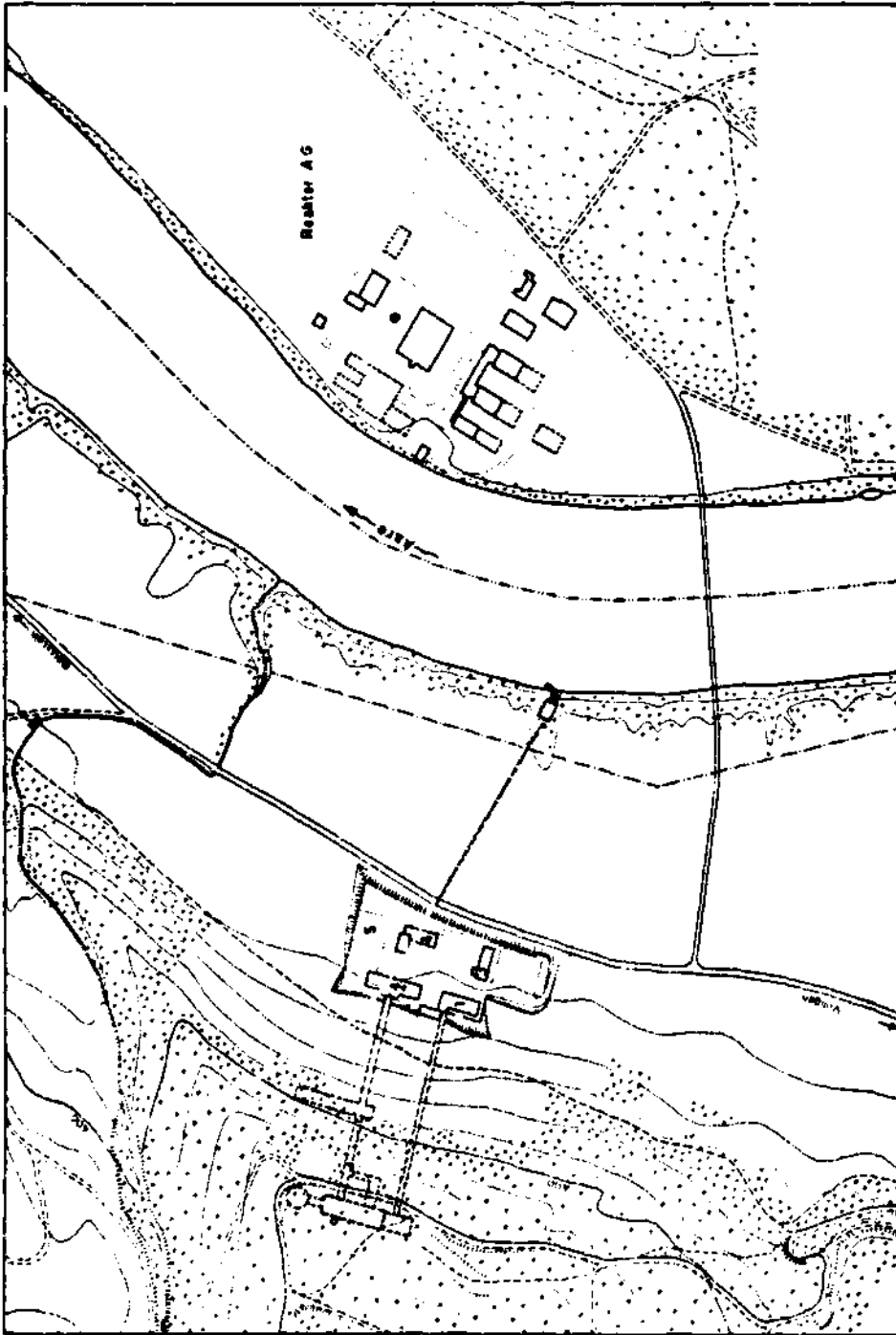

Fig. 3 - 15 Transverse section of the AARE plant



1 SERVICE BUILDING 2 LABORATORY 3 CANTEEN 4 WORKSHOP 5 VENTILATION BLDG

Fig. 3 - 16 Aare reactor: site plan

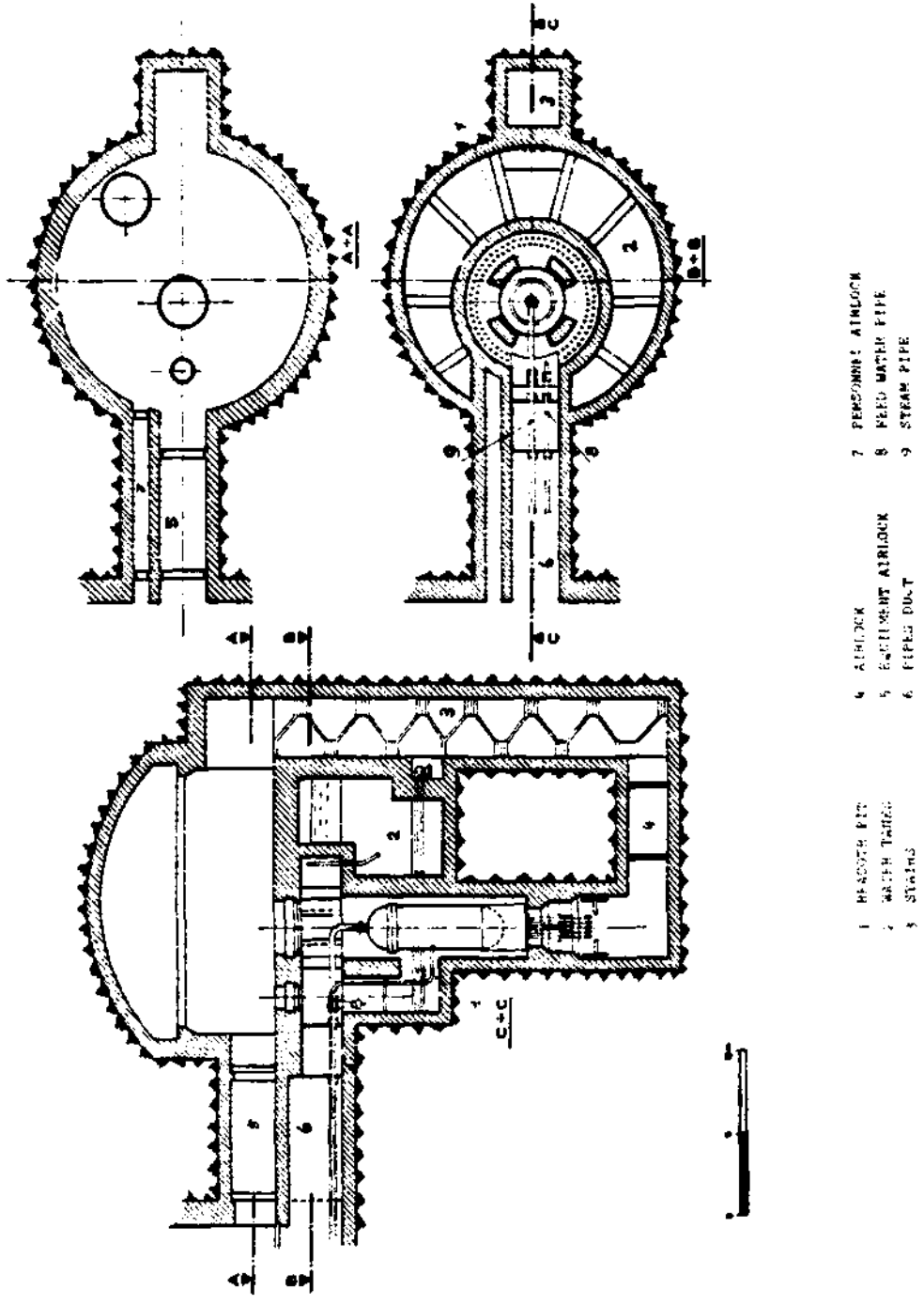

Fig. 3 - 17 Aare reactor: reactor cavern sections

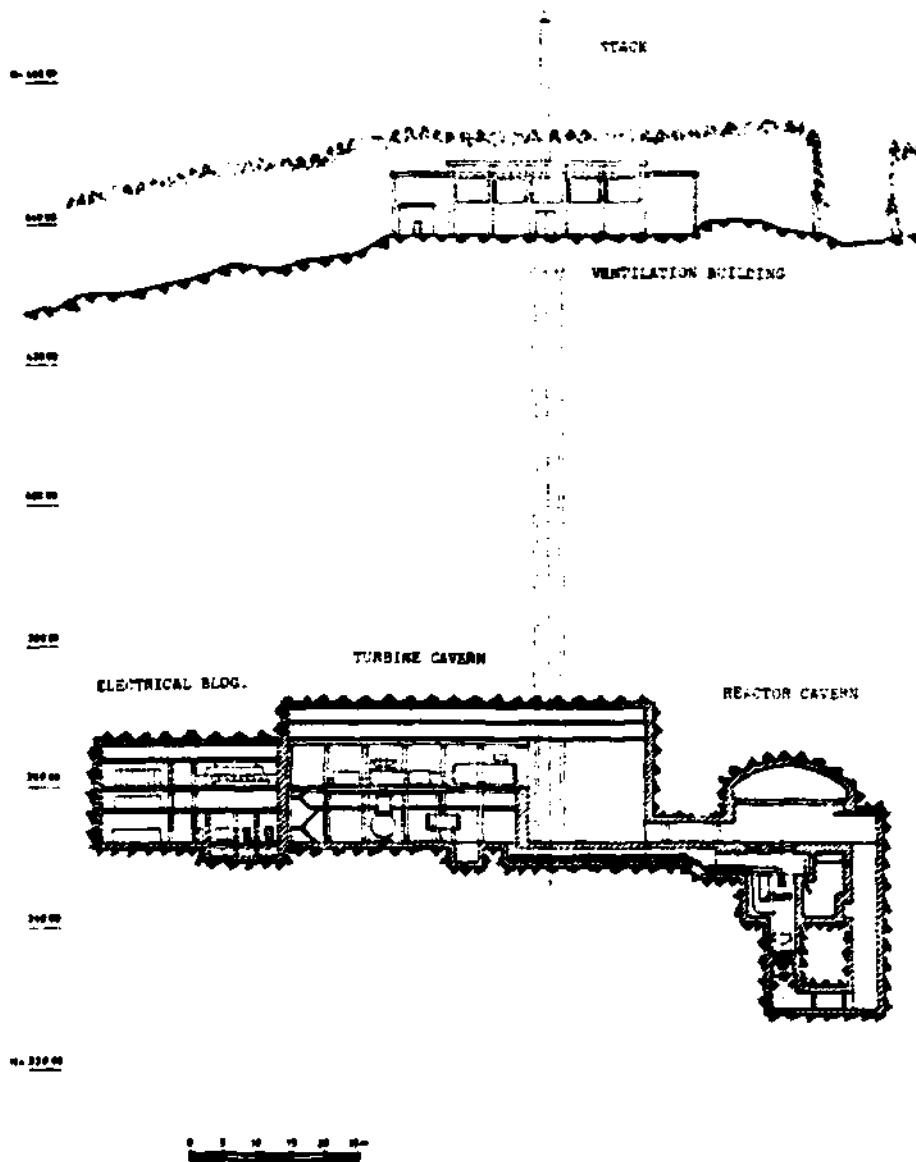

Fig. 3 - 18 Aare reactor: plant cross section

The chosen location was a hill in Villigen, on the left bank of the river Aare, opposite to the premises of the Reaktor AG, now the Swiss Federal Institute for Reactor Research.

The chosen reactor was a GE direct cycle boiling water reactor rated 65 MW(th) (about 20 MWe).

- 3.7.2. The underground portion of the plant is located in a hillside and consists mainly of two caverns, the reactor and turbine caverns, and tunnels.

The reactor cavern is cylindrical with a domed roof. The dimensions of this cavern are 35.2 m maximum height and about 16.6 m diameter.

In the cavern, the reactor vessel is located in a pit lined with steel plates. All around the upper level of the pit there is the pressure suppression system consisting of interconnected water tanks containing about 1000 m³ of water.

These tanks are lined with steel plates.

A spray system to quench the steam pressure is also installed in this cavern.

The reactor cavern, which cannot be entered or ventilated during operation, is connected to the turbine cavern through a short two floor tunnel equipped with an airlock. The upper floor is divided in two, a personnel and equipment passage. In the lower floor, piping and cables run through two separate channels.

- 7.3. The turbine hall is located in a horseshoe shaped cavern about 55 m long, 20 m high and 15 m wide.

In this cavern, besides the turbine and some related auxiliaries, there is also the spent fuel pit while the water treatment systems are located in an adjacent tunnel.

The turbine hall cannot be entered during normal plant operation.

The control room and electrical equipment are located in an extension (about 27 m long and 15.4 m high) of this cavern, separated from the turbine hall by a leaktight wall.

- 7.4. Connections to the surface are by means of two tunnels, one for personnel and the other for equipment.

The personnel tunnel connects the electrical equipment area with the service building on the surface.

This tunnel is divided in two floors: the upper floor is for personnel passage and for the ventilation system (fresh air) to the plant not controlled areas, while the lower floor is for electrical cables and exhaust.

The equipment tunnel, also divided in two floors, connects the montage area in the turbine hall with the laboratories building on the surface.

The tunnel, about 190 m long, is equipped with an airlock and is also utilized for personnel access to the controlled area of the plant.

Water cooling pipes, to and from the river Aare, run in the

lower section of this tunnel.

About 60 m from the turbine cavern, on one side of the equipment tunnel, there is a gallery for the storage of radioactive wastes.

- 7.5. The service building, laboratories, workshops and other infrastructures (including a reactor simulator) are located on the surface, in front of the access tunnel. On the hill, there is the ventilation building for the treatment of the exhaust from the plant controlled area with a 20 m high stack.

It is very interesting to note that an auxiliary source of cooling water utilizing groundwater was also provided for in this project.

- 7.6. The main reasons that lead to design this reactor underground was to pursue a higher protection for the population and the environment utilizing the rock as an additional barrier against radioactive releases.

3.8. COMPARISON AMONG THE STUDIES

3.8.1. If these early studies are compared together or with the other studies that will be described in the next chapters, it can be seen that, with the exception of the USAEC study, they have the characteristics of preliminary projects.

It should not be forgotten, infact, that while the two swedish projects previously described have lead to the construction of the Ågesta plant, the studies performed in Switzerland have prepared the road to the realization of the Lucens experimental nuclear power plant. The similarities between this last plant and the swiss studies, here summarized, are evident.

Only the USAEC study, among the studies here mentioned, was not meant as a preliminary project phase, but was meant to assess and to evaluate advantages, disadvantages, costs and site requirements for a possible underground location of nuclear power plants.

3.8.2. All these early studies are relating to the rock cavity alternative. Both possible variations, the hillside and the deep below the surface variation are taken into account together with the totally and partially underground plant alternative.

These studies have, however, some other basic common characteristics.

Infact

- they are all relating to single elevation plants
- they all require small cavern spans
- they all require a lining for the reactor cavern
- they are all relating to small power reactors
(maximum power about 75 MW(th)).

Moreover, common characteristic for the european studies is the location of the underground plants in densely populated areas.

3.8.3. In these studies, among the various possibilities offered by the underground siting of a nuclear plant, advantage has been mainly taken only of the rock mass both as an additional containment in case of major accidents associated with radioactive releases and as an improved protection for the plant in case of a war attack.

With the exception of a gravity-fed emergency water spray system mentioned in the project of Energie Nucléaire S.A., other possibilities have not been considered.

3.9 THE MOTIVATIONS

3.9.1. The motivations for these studies are mainly related to safety in case of major accidents or in case of acts of war.

However, for the first time, the psychological advantages of the underground siting are mentioned together with the reduction of the seismic loading on structures located in rock.

Another important motivation is the siting of plants, devised for a district heating system, in highly populated areas as the town of Zürich or the suburbs of Stockholm.

More details on the motivations are given in the preceding paragraphs for each plant.

3.9.2. In summary it can be stated that, with the exception of the USAEC study, the main reasons that have lead to investigate, at a preliminary project stage, the underground siting of these reactors are:

- the greater safety because of the additional level of containment given by the rock, in case of major accidents
- a better protection against acts of war
- the possibility of siting the plants in populated areas

Possible economic advantages of the underground siting have also been mentioned.

PROJECT OR STUDY	YEAR	REACTOR TYPE AND RATING	PLANT CONFIGURATION	CONTAINMENT TYPE AND DIMENSIONS (l x w x h) m
ENERGY RESEARCH PROJECT (CH)	1957 - 1958	indirect cycle BWR 5 MWe	hillside plant partially underground	Rectangular rock excavation gastight 57 x 10 x 32
SAEC STUDY (USA)	1957 - 1958	EBWR 5 MWe	hillside plant totally underground	cylindrical rock excavation lined with concrete $\phi = 24.5$ m
RA PROJECT (S)	1955 - 1958	natural uranium, heavy water reactor (pressure vessel type) 75 MWth	hillside plant partially underground	Rectangular rock excavation lined with concrete 53 x 15.6 x
ALAN PROJECT (S)	1958	natural uranium, heavy water reactor (pressure vessel type) 75 MWth	deep below the surface plant totally underground	Rectangular rock excavation lined with concrete
SULZER PROJECT (CH)	1956 - 1958	natural uranium, heavy water reactor (pressure tube type) 30 MWth	deep below the surface plant totally underground	cylindrical rock excavation lined with concrete $\phi = 20$ m
RESEARCH PROJECT (CH)	1957 - 1959	GE - BWR 20 MWe (65 MWth)	hillside plant partially underground	cylindrical rock excavation $\phi = 16.6$ m

Table 3 - 1 Main characteristics of the early studies

3.10. CONCLUDING REMARKS

3.10.1. In this chapter, some of the main studies performed on the underground siting in the late fifties have been examined. The majority of these studies have been carried out in Switzerland and Sweden.

A summary of the most significant characteristics of these studies is given in Tab. 3 - 1.

3.10.2. All these early studies are relative to the rock cavity alternative with the two main variations, hillside and deep below the surface. The possibility to have the plant totally or partially underground has also been considered.

Mainly as a consequence of the motivations, in these studies on the underground siting advantage has been taken only of the additional level of containment given by the rock. Other possibilities given by the inherent characteristics of this type of siting have not been taken into account.

3.10.3. The main distinctive peculiarity of the studies performed in Switzerland and Sweden is their character of preliminary project.

It should be noted that some of these studies have actually contributed to the construction of the Lucens and of the Ågesta plant.

Only the study performed by USAEC has not this characteristic being only meant to assess, together with site requirements, advantages, disadvantages and cost penalties of the underground siting.

References

- 3-1 D. R. Inglis, G.R. Ringo
Underground Construction of Power Reactors
ANL-5652 January 1957
- 3-2 Energie Nucléaire S.A.
Avant-projet de centrale nucléaire de 5 MWe
Novembre 1957
- 3-3 M. Cuénod et al.
Experimental Nuclear Energy Power Plant of the
Energie Nucléaire, S.A.
2d U.N. International Conference on the Peaceful
uses of Atomic Energy
Geneva 1 - 13 Sept. 1958 P/252
- 3-4 C. Beck
Engineering Study on underground construction of
nuclear power reactors
AECU - 3779, April 15, 1958
- 3-5 I. Wivstad, C. Mileikowsky
Adam - A 75 MW Nuclear Energy Plant for House
Heating Purposes
2d U.N. International Conference on the Peaceful
uses of Atomic Energy
Geneva 1 - 13 Sept. 1958 P/136
- 3-6 P.M. Margen et al.
R3 - A Natural uranium, heavy water reactor for
combined electricity production and district heating
2d U.N. International Conference on the Peaceful
uses of Atomic Energy
Geneva 1 - 13 Sept. 1958 P/135

- 3-7 Projekt der Arbeitsgruppe für die Errichtung
einer Atomenergie-Heizkraftanlage an der ETH
Dritter Bericht, 15. Mai 1958
- 3-8 P. de Haller, A.F. Fritzsche
Sulzer Project for a prototype heavy water power
reactor for location in an underground cavern
2d U.N. International Conference on the Peaceful
uses of Atomic Energy
Geneva 1 - 13 Sept. 1958 P/246
- 3-9 Projekt des Konsortiums für die Erstellung eines
Versuchs-Atomkraftwerkes, Standortvariante Villigen.
Ergänzung zum dritten Bericht. 27. Oktober 1958
- 3-10 Suisatom AG
Erster Geschäftsbericht und Jahresrechnung über
das Geschäftsjahr 1957/1958
- 3-11 Suisatom AG
Beschreibung des Versuchskraftwerks Aare
Projektierungsstand Ende April 1959
Beilage zum ersten Geschäftsbericht
- 3-12 S. Pinto
A survey of underground nuclear power plants
Part 3. The early studies
TM-St-524, November 1977

CHAPTER 4

THE MAIN AMERICAN STUDIES

<u>Contents</u>	<u>Page</u>
4.1 Introduction	4-5
4.2 The Harza Engineering Study	4-6
4.3 The Bechtel Study	4-12
4.4 The Acres-United Engineers Study	4-17
4.5 The Stone & Webster Study	4-23
4.6 The Clinch Valley Study	4-28
4.7 The Aerospace Corporation Study	4-31
4.8 The Lawrence Livermore Laboratory Study	4-43
4.9 The California Power Plant Siting Study	4-47
4.10 The Sandia Study	4-55
4.11 The California Energy Commission Study	4-61
4.12 Comparison among the studies	4-71
4.13 Concluding remarks	4-74

1.1. INTRODUCTION

1.1.1. After the construction of the four european underground nuclear plants, due to a better understanding of the nuclear phenomena and to the increased level of safety of surface plants, very little interest has been shown for the underground siting concept.

In these past years, however, several factors have renewed the interest for the underground siting as a real alternative to surface siting.

Among these factors we can mention the decreasing number of suitable sites above ground, the increased difficulties in obtaining site approval by the licensing authorities, the increasing opposition to nuclear power, the possibility of utilizing the waste heat for district heating systems and the possibility of urban siting.

As a consequence, studies meant to evaluate the feasibility, the economic impact and the potential safety advantages of the underground siting have been undertaken in various countries.

1.1.2. The main studies performed in these last years in the USA are shortly described in this chapter.

4.2. THE HARZA ENGINEERING STUDY

- 4.2.1. The study of the Harza Engineering Company was performed as an in-house investigation in 1970.

For the study, a twin 1000 MWe BWR plant has been chosen. The design of the underground plant has been carried up to a point where the costs of the underground siting could be estimated (Ref. 4 - 1, 4 - 2).

- 4.2.2. The twin BWR units are located as shown in Fig. 4 - 1 in an underground rock chamber about 135 m below the surface.

Turbines, condensers, generators and related equipment are in two buildings located in a pit excavated to a depth of about 45 m below the surface. The chosen configuration of the turbines building is such that the roof is approximately at ground level.

Steam lines extend from the reactors through vertical shafts to the turbines building.

- 4.2.3. The reactor hall is about 25 m wide and has a total length of about 168 m.

The maximum height of this chamber is at both ends, where the reactors are located, and is about 73 m. In the center of the hall, instead, the floor level is stepped up so that the height of the chamber is about 21 m.

Fig. 4 - 2 shows the general reactor arrangement.

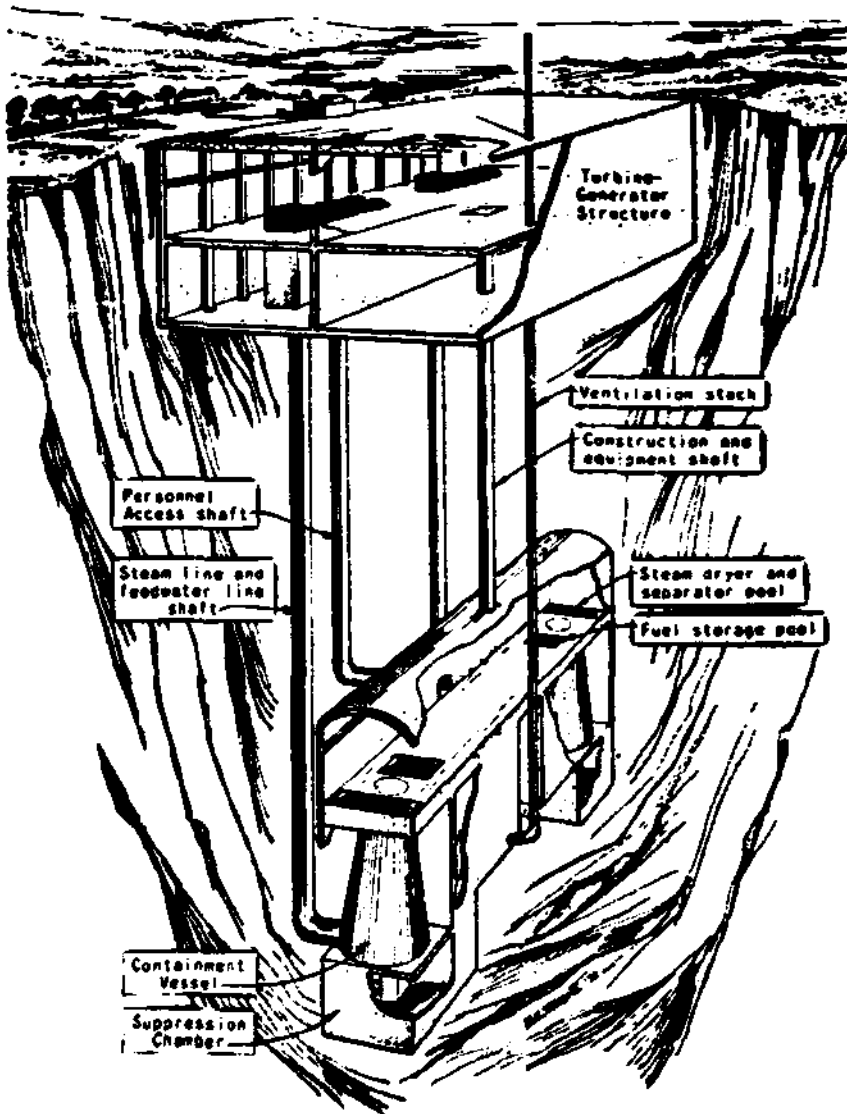

Fig. 4 - 1 Harza Engineering Study: underground plant arrangement

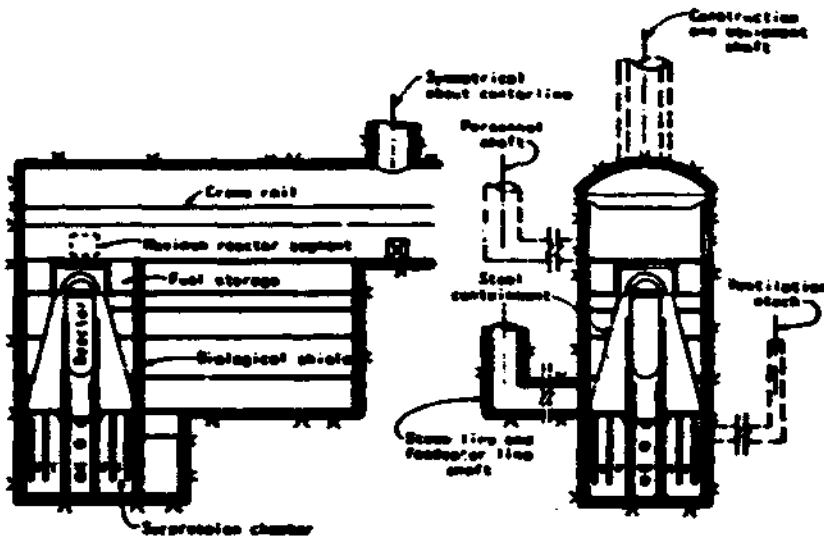

Fig. 4 - 2 Underground reactor containment

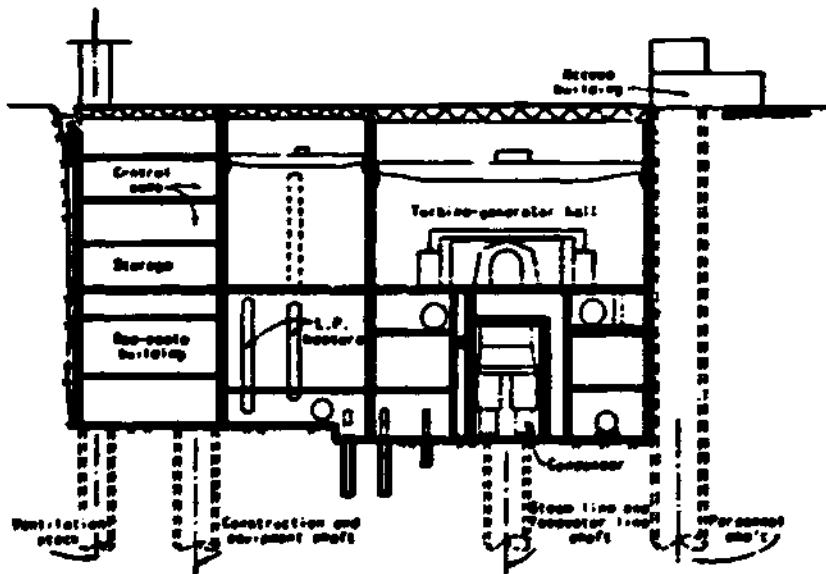

Fig. 4 - 3 Turbine generator structure

Reactor auxiliary systems are mainly arranged as in above ground plants. However, space that above ground would normally exist outside the containment on the sides of the chamber is redistributed in the length of the underground chamber. In this way, the span of the cavern can be kept within the limits of existing man-made cavities.

The building housing the turbines and related equipment is about 80 m wide, 210 m long and extends to a depth of 45 m below the surface. This building is shown in Fig. 4 - 3.

4.2.4. Access to the underground chamber is provided by five shafts extending downward from the turbines building.

One shaft, about 7.5 m in diameter provides access for personnel by means of an elevator and stairs and contains control cables. The steam and feed water pipes pass through two shafts about 6.5 m in diameter. A shaft about 8.3 m in diameter, which runs at the center of the underground chamber, is used during construction for lowering equipment. The fifth shaft, about 4.5 m in diameter is connected to a stack on the surface.

To avoid problems lowering the reactor vessel in one piece in the underground hall through a shaft, sections of the vessel, fabricated above ground, should be assembled in place.

4.2.5. The excavation volume for the shafts and tunnels and galleries is about 3900 m³, while the excavation volume of the reactor chamber is about 23 000 - 30 000 m³ depending on the chosen configuration.

All the excavation, including the pit for the turbines building (about 76 500 m³), concreting, installation of cranes, elevators, drainage systems, etc. would require 1 1/2 - 2 years. This estimate is based on an excavation rate of about 76.5 m³ per day during 25 working days per month.

	YEAR							
	QUARTER 1				QUARTER 2			
	1	2	3	4	1	2	3	4
Move-in and set-up	█							
Excavate								
Access shaft		█						
Drift to other shafts			█					
Raise drill other shafts				█				
Slash shafts				█				
Reactor chamber				█	█	█	█	█
Concrete								
Shafts		█	█	█				
Reactor chamber roof				█	█	█		

Fig. 4 - 4 Construction schedule

4.2.6. According to the study, an underground plant should be located at a depth where the groundwater pressure will exceed the maximum design pressure avoiding, in this way, the possibility of fission products escaping to the atmosphere through fissures in the rock overburden.

Therefore, the roof of the underground cavities should be located between 45 and 75 m below the groundwater table.

4.2.7. The main advantages of the underground siting are considered to be:

- superior biological protection

- superior containment
- better protection against external events, natural and man related, including earthquakes and sabotage
- improved aesthetics
- possibility of siting the plant in highly populated areas
- reduction of transmission costs locating the plant near major load centers.

Another advantage claimed by the study is the possibility of sealing the containment in case of major accidents or at the time of decommissioning.

4.2.8. The incremental cost of undergrounding two 1 000 MWe BWRs is about \$ 10/KW for a plant such as that previously described. If the plant is totally located underground, i.e. also the turbines are in rock caverns, the additional cost is about \$ 18/KW.

4.3. THE BECHTEL STUDY

4.3.1. This study was performed for Southern California Edison Company in 1970 (Ref. 4 - 3). The investigation considered the technical, economical and licensing feasibility of a 1 100 MWe nuclear power plant for an underground location at a Southern California site.

The aim of this study was to establish a design concept for an urban site that could provide maximum public safety and have an excellent chance for public acceptance and approval by the regulatory authorities (Ref. 4 - 3).

4.3.2. The study is based on a 1 100 MWe four-loop PWR.

Basic criteria for the proposed layout are that all safety related components and equipment be located underground and that the plant be designed for "near zero radioactive release". As a consequence of these criteria many innovations have been included in the design.

A specific site was chosen for the investigation. In this site the groundwater table is at or just a few centimeters below the natural ground level. This fact together with the site material (dense sand below marsh land) have lead to consider not feasible to construct a deep, completely underground facility.

Therefore the embedment depth is such that the reactor building roof is approximately at ground level.

4.3.3. The underground building consists of a double cylinder structure about 70 m in diameter and 72 m high (Fig. 4 - 5).

With the exception of the bottom, the primary containment is surrounded by a secondary containment which includes also the space above the primary containment.

The primary containment houses the NSSS and the secondary containment houses all systems and equipment handling radioactive material.

The primary containment is completely lined with carbon-steel plates. The secondary containment has a similar liner down to an elevation where the groundwater pressure is higher than the containment design pressure.

All reactor auxiliary systems are located in the reactor building.

The fuel pit is also located within the primary containment while the cask handling pit is in the secondary containment. The pressure, in this containment, is maintained below atmospheric.

Control rooms, auxiliary feedwater pumps and diesels are located in the reactor building.

4.3.4. Many innovations have been incorporated in the design as, for instance:

- a chemical air revitalization system provided in the secondary containment so that the need for purging exhaust air to the environment can be eliminated,

- a charcoal filter cleanup system located in both containments providing "an optimum arrangement for post-accident fission product removal" (Ref. 4 - 3),
- steam generator relief suppression pools.

A layout in which the turbine plant was supported by the reactor containment has also been investigated.

3.5. Three construction methods have been investigated for the underground reactor building: freeze walls, sunk caissons and the slurry trench technique.

While all these methods are considered feasible, the freeze wall technique has been considered the most attractive because of advantage in cost and schedule for the chosen site.

3.6. The main advantages of the underground siting are considered to be:

- improved biological shielding because of the surrounding soil and water,
- better protection against external events including flooding, fires, missiles, explosions, aircraft crashes and earthquakes,
- better protection against acts of sabotage,
- reduction of leakage possibility because of the soil loads and the water hydrostatic pressure.

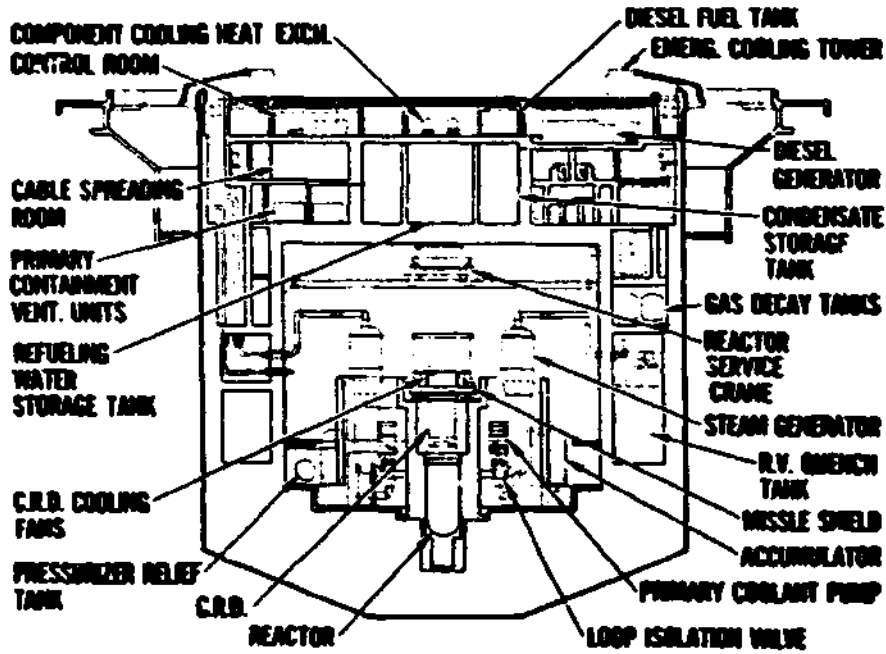

Fig. 4 - 5 Underground reactor building arrangement: section

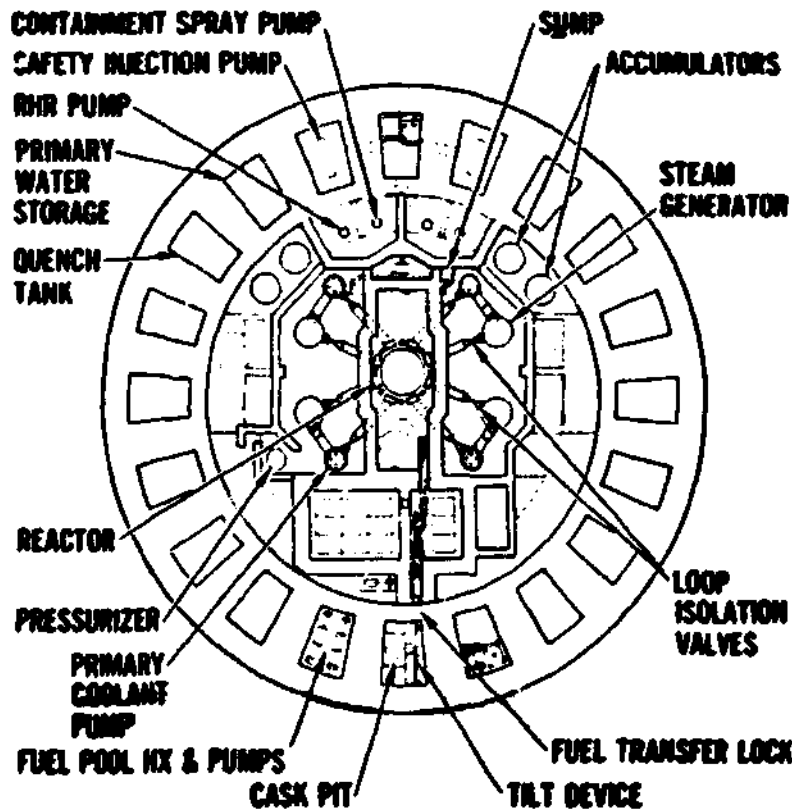

Fig. 4 - 6 Underground reactor building arrangement: plan

3.7. The cost increase of this underground plant is about 50 % of the cost of a conventional surface PWR. The time required to build such a plant, including licensing is considered to be about 15 years.

4.4. THE ACRES-UNITED ENGINEERS STUDY

4.4.1. The study was performed by United Engineers and Constructors Inc. and Acres American Inc. between 1970 and 1972 as an in-house study (Ref. 4 - 4).

All information summarized hereafter is taken from Ref. 4 - 4 to 4 - 7.

4.4.2. The study is based on a 1000 MW PWR plant similar to Indian Point 3.

The whole plant, with the exception of the switchyard and administrative buildings, is located underground, about 90 m below grade in a competent igneous rock mass (Fig. 4 - 7).

The approach taken in this study was to separate, as much as possible, the nuclear from the nonnuclear elements of the plant. Thus the reactor containment, the fuel storage building and the auxiliary building are located at one side of the complex. The turbine hall, the heater bay, turbine auxiliary equipment, transformers, etc. are located at the other side, in long parallel cavities (Fig. 4 - 8).

The emergency diesel units are located at a higher elevation in a separate rock chamber.

4.4.3. The reactor containment is a right circular cylinder with an hemispherical dome, about 70 m high and 42 m in diameter. A

steel liner, backfilled with concrete, has been provided.

The turbine hall is a 30 m wide cavity lengthened at both ends to allow space for erection.

The relative position of the cavities locating the heater bay and the transformer bay with the turbine cavern has been chosen in such a way as to minimize the connecting pipe runs. The circulating water tunnel leading to the condenser in the turbine hall passes beneath the cavities.

A first stage of transformation has been provided underground.

4.4. A certain number of vertical shaft penetrations to the underground plant are required (Fig. 4 - 7).

These penetrations include ventilation ducts for the emergency diesel generation, supply and exhaust ducts for reactor containment ventilation, personnel and material elevators, ventilation of the turbine hall and associated cavities, cables ducts from the transformer gallery and the circulating water tunnels to the turbine hall.

An access tunnel for transport of large and heavy components is also provided for. This tunnel, constructed at about 7° grade, is 1850 m long and has a diameter of about 10 m.

The provision of rapid sealing and isolation systems to isolate all shaft and tunnel penetrations in case of accidents is considered feasible.

Water seals systems have also been suggested as well as the possibility of flooding the reactor cavern as ultimate safeguard.

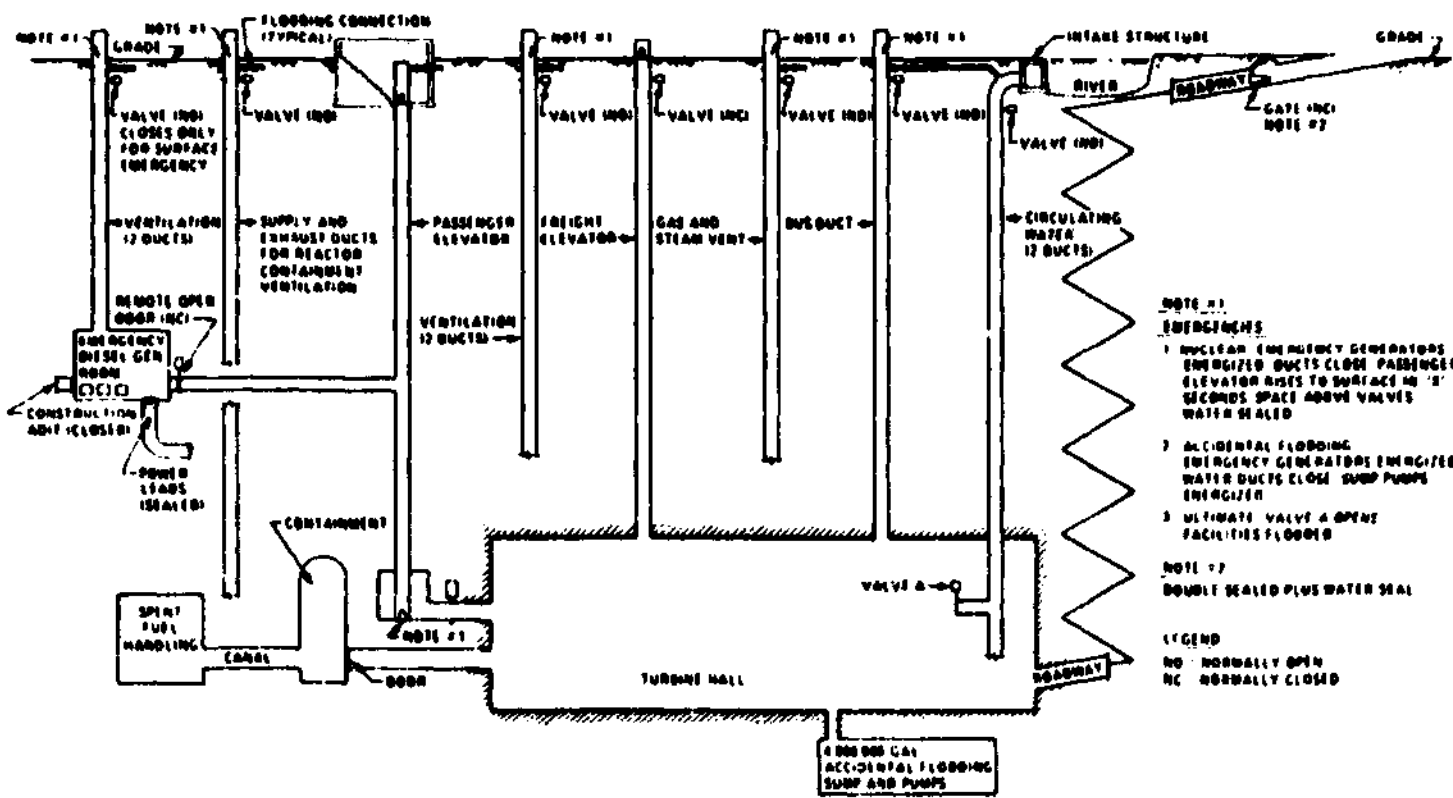

Fig. 4 - 7 Underground plant layout: vertical section

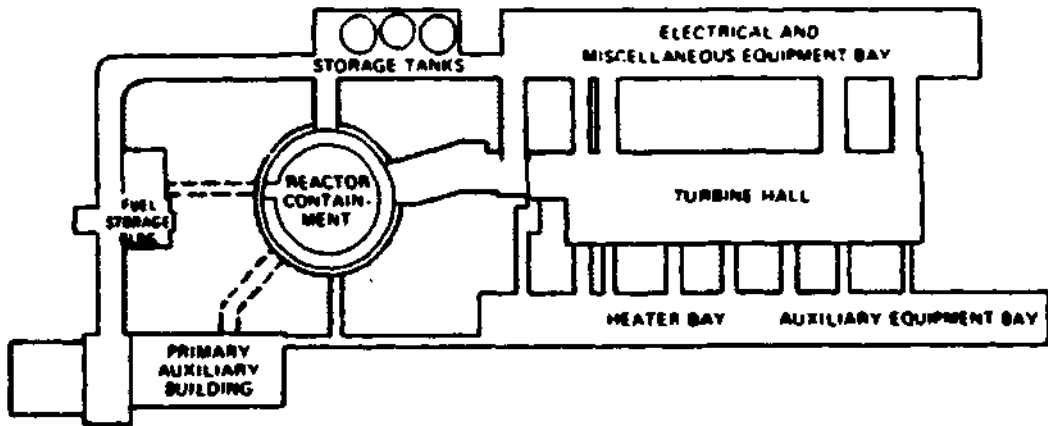

Fig. 4 - 8 Underground plant layout: plan

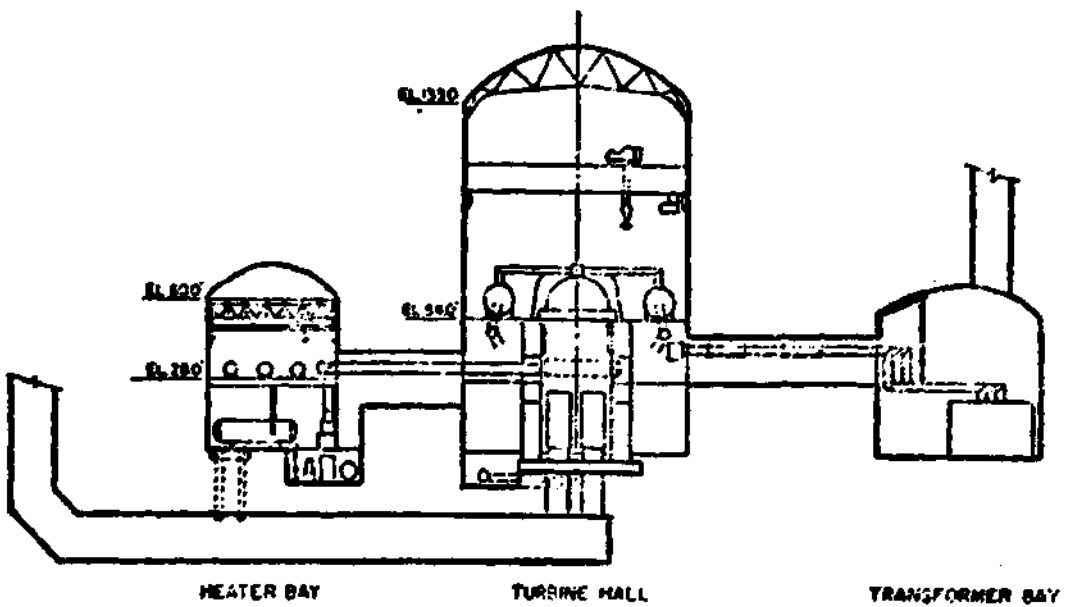

Fig. 4 - 9 Underground plant layout: cross section

4.4.5. According to the study, in order to have a self supporting rock arch in a cavity, a rock cover in the order of twice the maximum cavity span is required. Therefore, in general, a 90 - 100 m cover is probably a reasonable assumption, both in terms of technical adequacy and economic factors.

At that depth, the groundwater pressure, if any, should also be higher than any possible accidental overpressure within the underground containment, avoiding in that way an outflow of radioactive contaminants.

For what concerns the seismic problem, the study suggests the interesting possibility of modifying certain aspects of the internal plant layout to allow the bracing of equipment and structures to the bedrock over their full height, thus avoiding the effects of amplification through the height. This fact could also have an economic importance.

4.4.6. The main advantages of an underground location are considered to be:

- immunity to surface phenomena
- modified and lessened seismic loading
- additional level of containment (up to two orders of magnitude in inventory reduction of a radioactive release)
- possibility of urban siting with reduction of exclusion area and savings in transmission costs
- simplification of plant decommissioning problems

Problems can be foreseen for what concerns:

- escape routes for personnel
- high-pressure condensers

4.4.7. It has been estimated that an underground plant will take 2 $\sqrt{2}$ years longer to complete than a surface plant. The costs of undergrounding are estimated to be 5 to 20 % higher than for a surface plant.

4.5. THE STONE AND WEBSTER STUDY

4.5.1. This study was performed in 1971 to investigate the feasibility of the underground siting, the advantages and disadvantages of the concept and its costs (Ref. 4 - 8).

Two different approaches have been proposed.

The first is a plant totally underground in which the entire installation, including the turbogroup and auxiliary facilities, is located in a series of underground caverns. The second is a near surface plant, built with the cut and cover technique, with the reactor and some nuclear components located underground but near the surface while the turbogroup and other conventional portions of the plant are located above ground.

In both concepts the switchyard is located at the surface.

4.5.2. The study takes as reference a BWR with a power rating in the order of 1000 to 1500 MW. Figs. 4 - 10 to 4 - 12 show the proposed layout for the plant totally underground.

The reactor is located in a cylindrical cavern with an hemispherical dome. The diameter of this cavern is about 46 m and the height about 73 m.

The turbogroup is located in a rectangular cavern with an arched roof about 30 m wide, 122 m long and about 40 m high. The layout of the turbogroup is quite conventional, with the condenser axial with the turbine to provide space for tubes withdrawal.

The control room is located in this cavern, at the reactor end of the cavity. Below the control room there is the switchgear.

- 5.3. On one side of the turbine hall there is the water treatment and radwaste building in a cavern 76 m long, 15 m wide and about 25 m high.

On the other side of the turbine cavern there is a transformer gallery housing the main power start-up transformer. High tension cables will reach the surface through a system of vertical shafts leading directly to the surface or through shafts to the access tunnel and then along this tunnel.

Emergency diesel generators are located in a separate cavern.

- 5.4. Access to the underground plant is provided by a tunnel constructed at about 10 % grade. The tunnel reaches the turbine hall at the elevation of the operating floor and, after being graded upwards, the reactor cavern at the elevation of the charging room floor.

A secondary branch of this tunnel reaches the basement floor level of the water treatment and radwaste building. A construction adit goes from this branch to the bottom of the reactor containment.

Other tunnels connect the various caverns at several different levels to facilitate excavation and equipment erection.

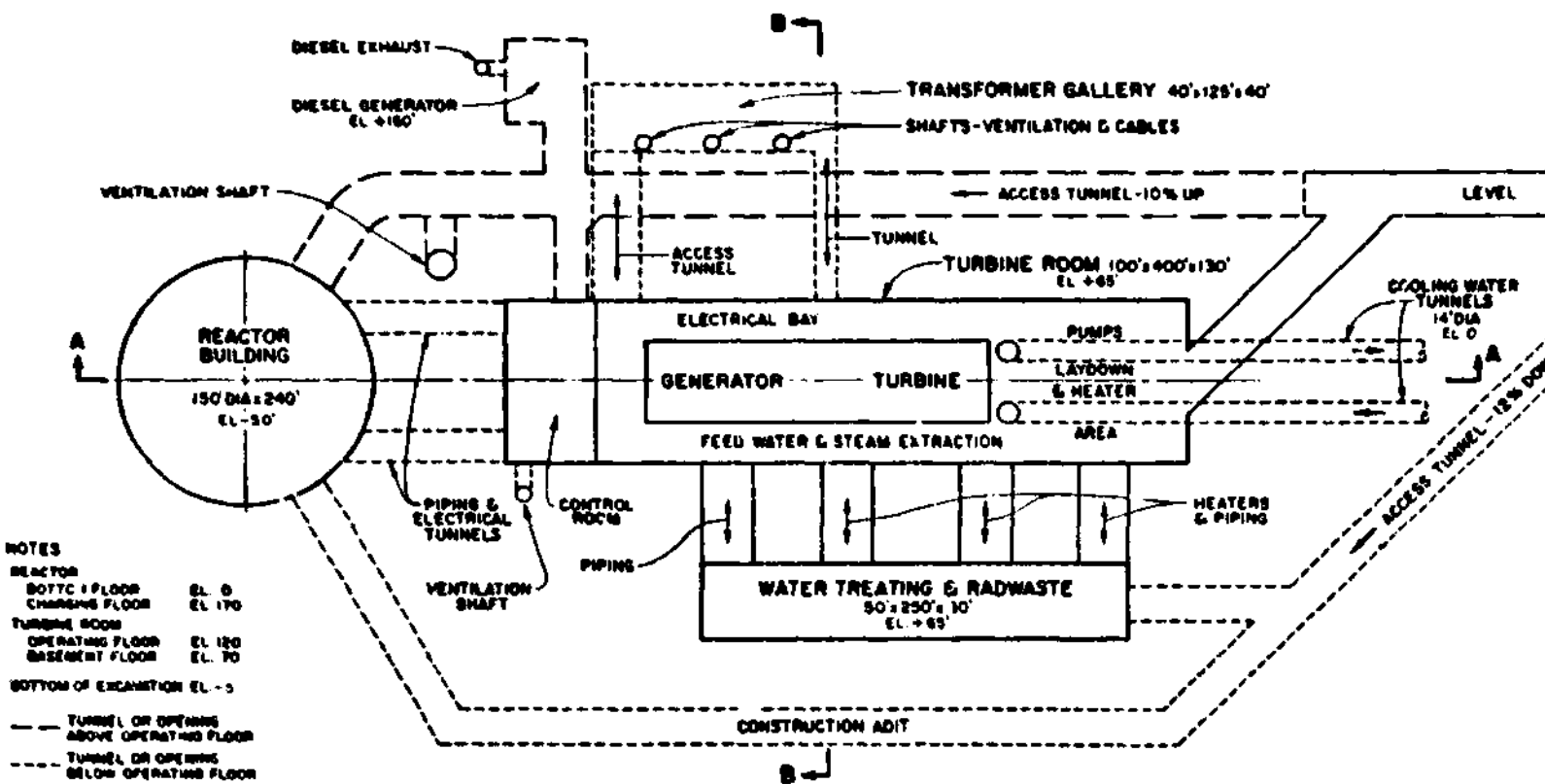

Fig. 4 - 10 Stone and Webster plant layout: plan

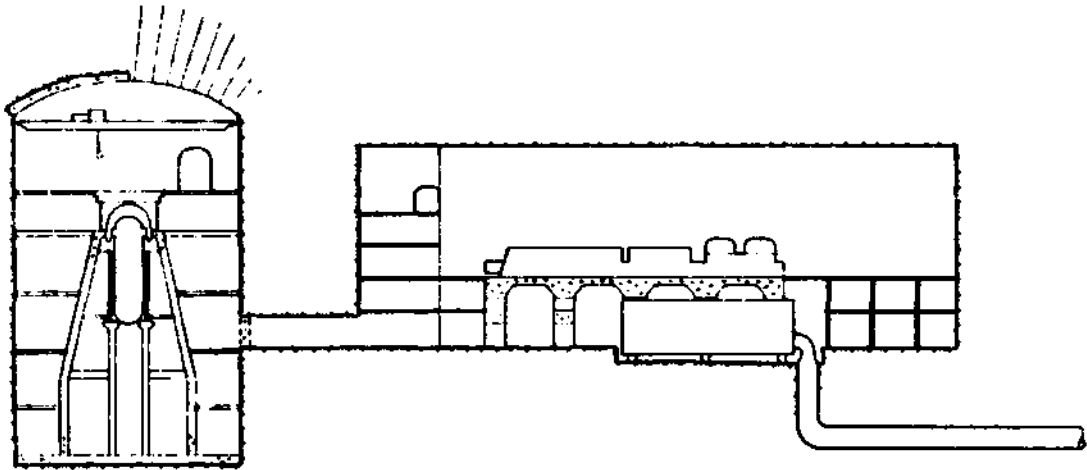

Fig. 4 - 11 Stone and Webster study: section A-A

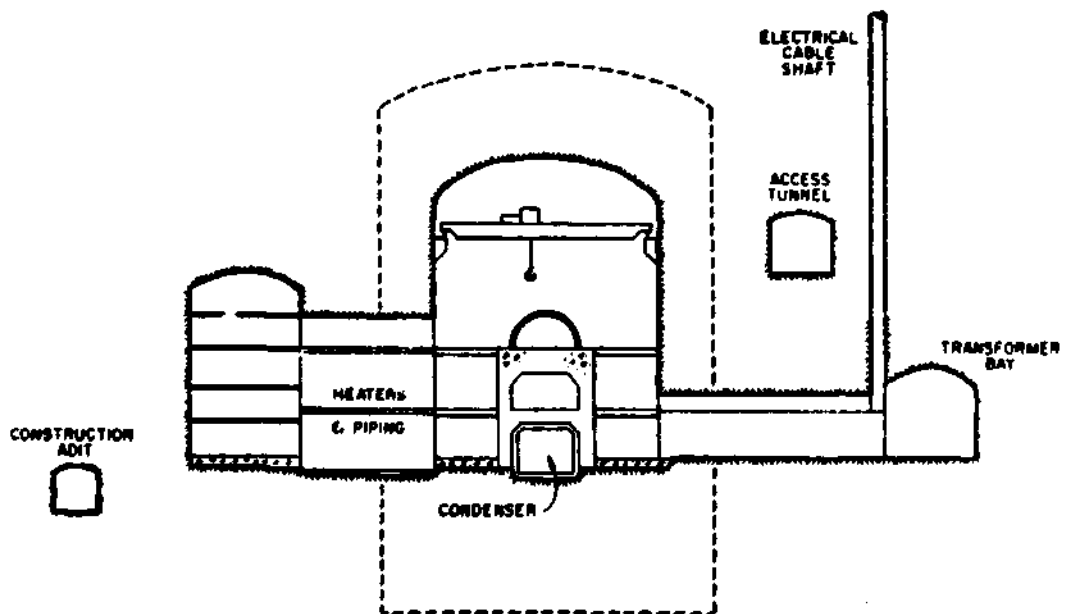

Fig. 4 - 12 Stone and Webster study: section B-B

4.5.5. The plant located partially underground is, for what concerns the layout, more similar to a surface plant than the plant totally underground.

While the alternative completely underground requires good rock quality to allow caverns with the required spans to be excavated, the near surface concept is considered adaptable to a greater variety of soil conditions.

Suitable for this underground siting concept are rock or rock-like materials in which excavations with near vertical walls, about 46 m in diameter and 46 m deep, can be made. Therefore, such a plant could also be constructed in mudstone, siltstone, etc.

4.5.6. According to this study, the main advantages of the underground siting are:

- improved public acceptance
- safety against external hazards such as tornadoes or aircraft crashes
- improved characteristics for design against earthquakes.

In fact, bracing structures against the cavern walls reduces the earthquake loadings allowing also savings in equipment and structures.

4.5.7. The underground siting is considered more expensive than surface siting but only by a modest amount.

4.6. THE CLINCH VALLEY STUDY

4.6.1. The report of the Clinch Valley study (May 15 - June 2nd 1972) suggests a scheme based on covering an above ground plant with crushed rock and earth backfill (surface mounded plant). According to the report "this containment system appears to have many of the advantages of the underground siting without many of the disadvantages, including high additional costs" (Ref. 4 - 9).

4.6.2. The plant is based on a 1000 MWe LMFBR (Fig. 4 - 13, 4 - 14).

The reactor building is cylindrical in shape, about 30 m in diameter, with a hemispherical dome. The building extends about 18 m below grade and about 30 m above grade. In this concept, an identical separate building houses the intermediate heat exchangers (IHx) and the steam generators. All the other buildings, covered by the backfill, are horizontal cylinders or hemicylinders with diameters varying between 12 and 18 m.

Connecting tunnels, through which vehicles can circulate, are cylinders about 6.5 m in diameter.

4.6.3. All the buildings directly connected to the reactor building or containing radioactive materials are buried. Therefore, fuel handling building, radwaste systems, turbine hall etc. are covered by the backfill.

The cover of all the buildings is a crushed rock and earth mound approximately 60 m high and with a radius of about 180 m, containing $2.3 \cdot 10^5 \text{ m}^3$ and costing about \$ $3 \cdot 10^6$. The

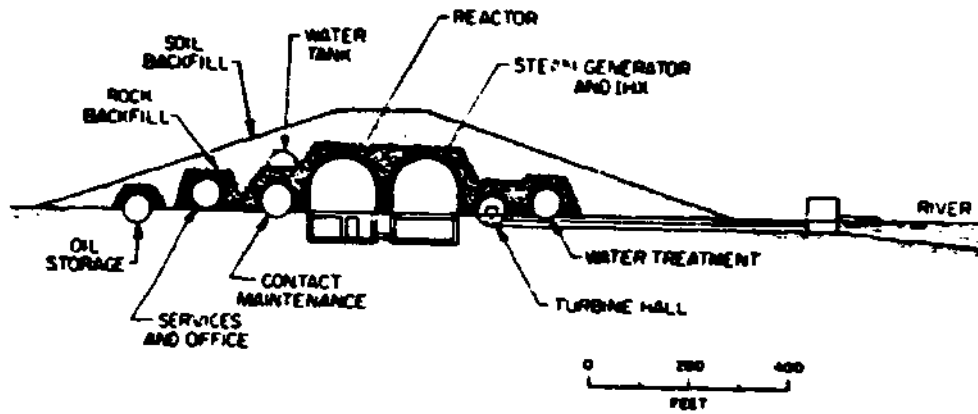

Fig. 4 - 13 Clinch Valley study: vertical section

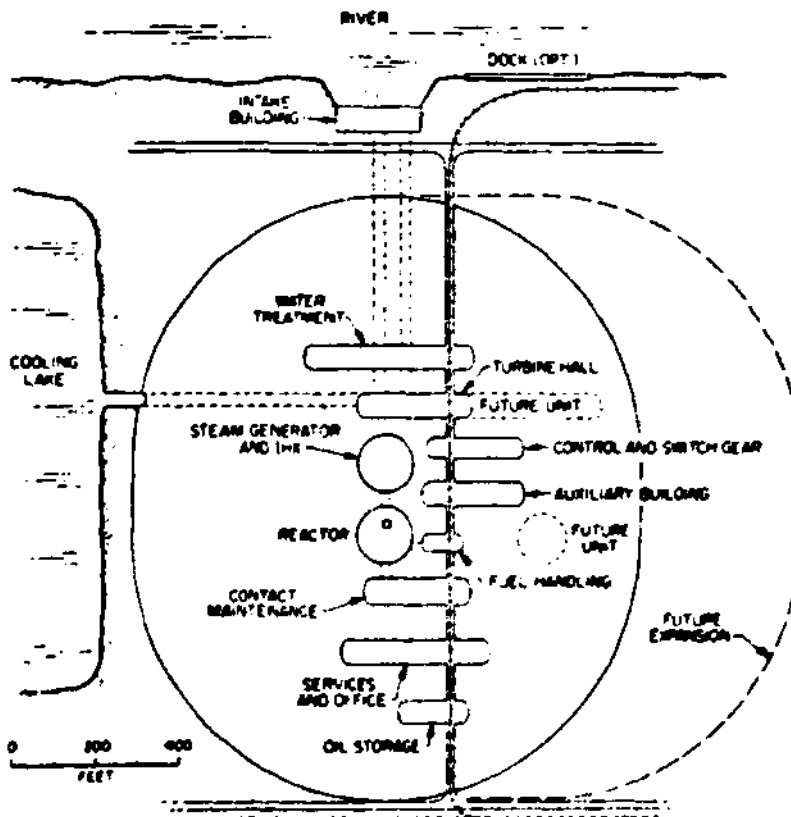

Fig. 4 - 14 Clinch Valley study: plan

weight of the cover poststresses the containment structure to resist internal pressure, reducing the requirement for prestressing steel. The slope of the mound is 3 : 1.

4.6.4. The advantages of this type of underground siting are considered to be:

- immunity to surface phenomena
- reduction of consequences of catastrophic accidents, the fission product inventory released being decreased by three or four orders of magnitude
- improved protection against overpressures because of the backfill and the buildings shape
- improved aesthetics
- possibility of urban siting
- reduction of land requirements because of the reduction of the restricted and/or exclusion areas
- reduction of transmission costs being possible to locate the plant close to load centers.

Moreover, the construction above the groundwater table eliminates the danger of accidental flooding caused by a failure of cooling water pipes or structures and permits an easy control of the drainage systems.

Catastrophic events leading to an unreparable condition of the underground plant have a relatively easy and inexpensive plant burial option with this type of construction.

4.7. THE AEROSPACE CORPORATION STUDY

4.7.1. This study (1972), jointly sponsored by the Aerospace Corporation and the Environmental Quality Laboratory of the California Institute of Technology, Pasadena, was meant to provide information for an evaluation of novel siting possibilities of nuclear power plants in California (Ref. 4 - 10).

The study is based on 1000 MWe LWRs (both BWRs and PWRs are taken into account). The underground siting alternative examined is the rock cavity plant.

4.7.2. The equipment associated with typical surface nuclear power plants has been located in four main underground cavities for both pressurized water reactor and the boiling water reactor.

The four caverns are the reactor cavern (housing the NSSS), the turbine generator hall, the auxiliary systems cavern (including fuel storage, radwaste storage, etc.) and a cavern housing the control room, the standby diesels, the switchgear, etc.

Three different underground plants have been examined. Two of these are a straightforward adaption of surface PWR and BWR plants to the underground site. The third consists of a reconfigured BWR plant in which the pressure suppression emergency system has been eliminated reducing in that way the cavern excavation volume.

Besides these siting alternatives concerning plants totally underground, a concept with surface turbine generators

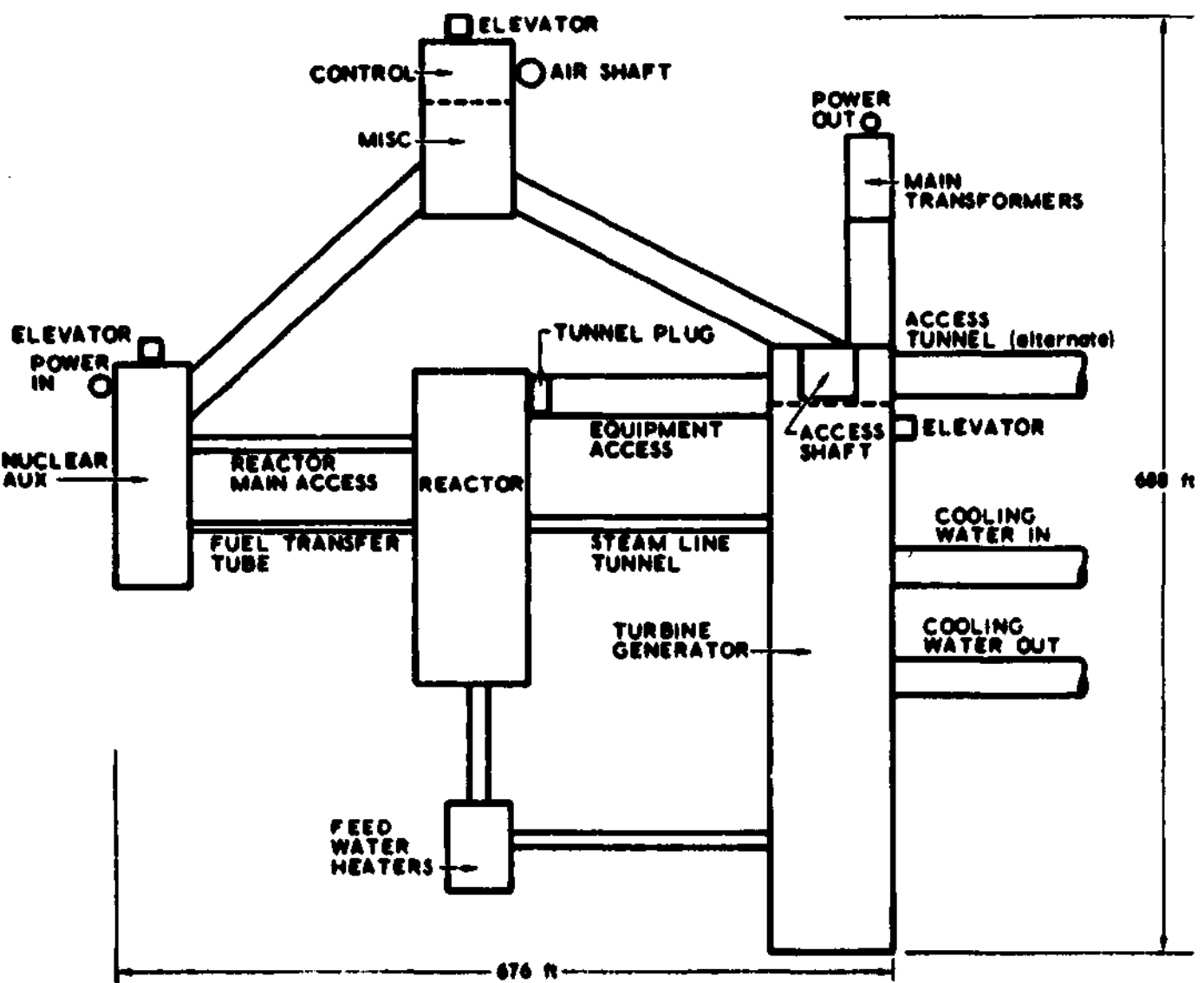

Fig. 4 - 15 Underground PWR plant layout

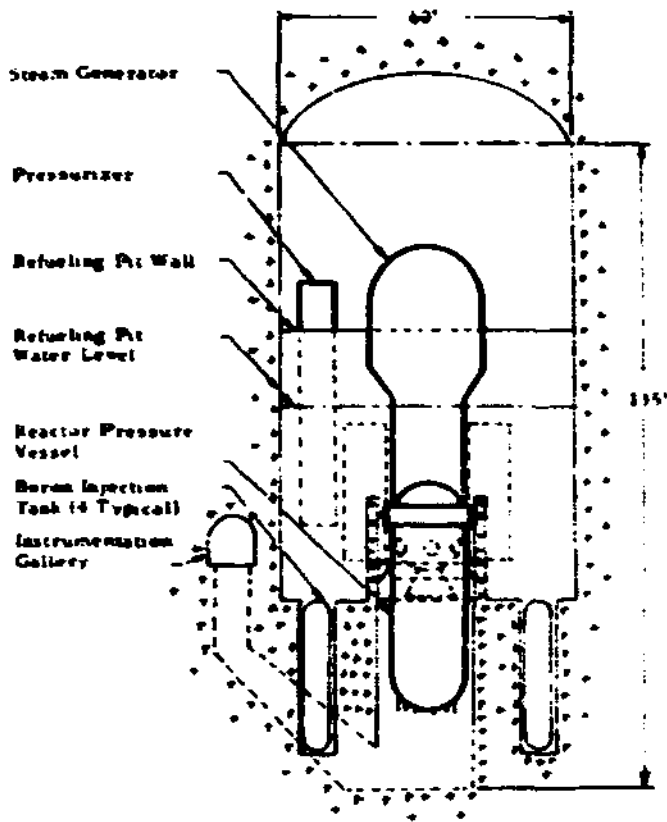

Fig. 4 - 16 PWR reactor cavern: vertical section

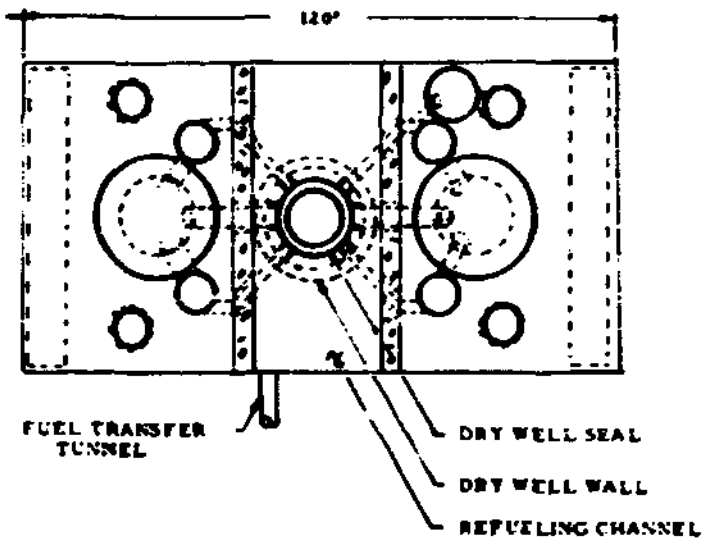

Fig. 4 - 17 PWR reactor cavern: plan

(plant partially underground) has also been examined (Ref. 4 - 11).

4.7.3. A main design assumption for the study was to retain unaltered the NSSS and turbine generator shape and dimensions, ensuring in that way that the operation and the performances of the plant would be very close to those of a surface plant.

Another important assumption was to limit the span of the underground cavities to less than 30 m and, when possible, to about 20 m.

4.7.4. As previously stated, the whole plant is located in four large underground cavities.

The orientation of the major cavities is such that their axes are parallel. A single elevation layout has been adopted, resembling more closely to a surface plant. The caverns are separated by a rock thickness slightly larger than one half the span of the largest underground chamber. A minimum rock overburden of 45 - 60 m is recommended for structural reasons.

4.7.5. The PWR plant configuration is based on a Combustion Eng. NSSS because of the shorter cavern span required.

The reactor hall is in a rectangular cavern about 37 m long, 19 m wide and about 42 m high (Fig. 4 - 15 to 4 - 17).

The emergency core cooling and containment spray pumps and valves are located in the auxiliary systems cavern. This

cavern is about 80 m long, 16 m wide and about 30 m high. The stack used to discharge gaseous waste has been replaced by a freon cryogenic system.

A departure from the refence design is given by the increased length (about 15 - 30 m) of the fuel transfer tube between the reactor and the spent fuel pit located in the auxiliary systems cavern.

The turbine generator cavern is the largest excavation of the plant. This rectangular cavern is about 109 m long, 28 m wide and about 30 m high.

Feed water heaters and fresh water condensers have been located in separate rock chambers adjacent to the turbine hall (Fig. 4 - 18).

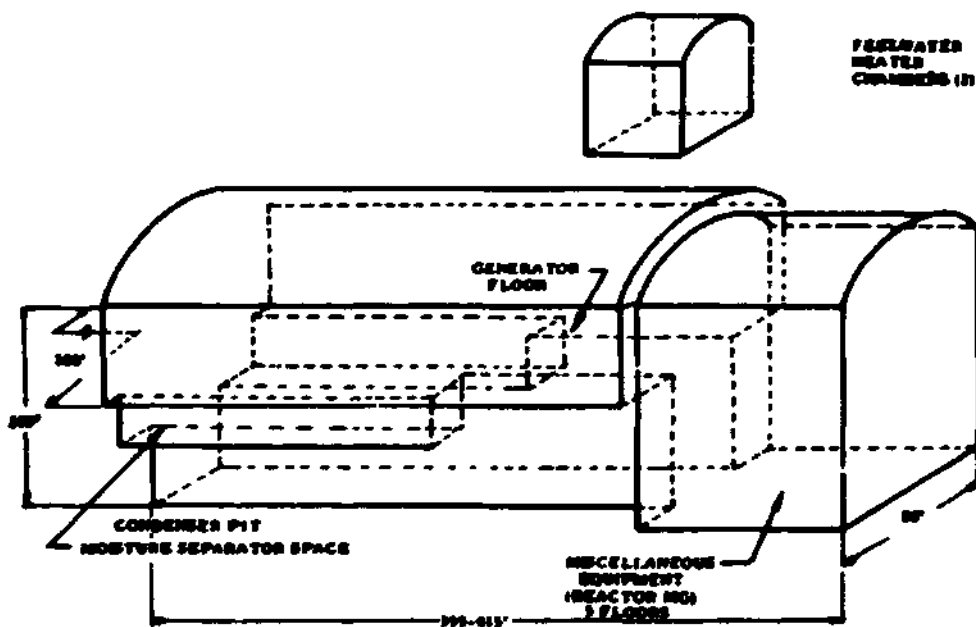

Fig. 4 - 18 Turbine generator cavern

Access to the plant is through vertical shafts, also used for ventilation and cables connections to the surface.

- 4.7.6. The design of the "minimum modified" BWR uses the inverted light bulb shaped drywell design with dimensions derived from the Quad Cities and Brown's Ferry plants. The design includes a reconfiguration of the toroidal suppression pool storage tanks and drywell interconnecting pipes. Some equipment has been reorientated to fit the shape of the underground reactor hall. The reactor cavern is rectangular in shape (Fig. 4 - 19, to 4 - 20) and is 65 m long, 23m wide and about 55 m high.

The turbine hall has been sized on a GE design. The span of the turbine cavern varies between 25 and 30 m, with or without the turbine radiation shield.

- 4.7.7. The reconfigured BWR plant was developed to reduce the caverns excavation volume and to utilize the inherent strength of the rock for containment.

The reactor is in a lined cylindrical cavern, about 20 m in diameter and 34 m high (Fig. 4 - 21, 4 - 22). A chamber excavated above the reactor allows handling of equipment with a crane. The chamber width is about 20 m.

Separate chambers adjacent to the reactor cavern contain the control rod drive and the emergency core cooling equipment.

4.7.8. For the siting alternative with the turbogroup above ground (Ref. 4 - 11), a PWR and a reconfigured BWR have been taken into account.

For the PWR, the surface NSSS was repackaged to permit installation within a rock chamber with a maximum span of about 20 m.

The plant is in four caverns, the reactor cavern (46 m high, about 20 m wide, 37 m long), the auxiliary equipment cavern, the electrical building and the ECCS pumps cavern.

Main difference with the reference plant is that the spent fuel is handled through the reactor cavern access shaft.

The reconfigured BWR plant is also located in four main cavities (Fig. 4 - 25, 4 - 26). The pressure suppression tanks have been modified and the drywell shape has been changed in a vertical right cylinder.

The reactor is located in a cylindrical well 26 m high and 20 m in diameter. Above the reactor well there is an excavated volume, rectangular in shape, occupied by the refueling channel, the fuel handling equipment and a crane. The overall dimensions of the reactor cavern are 62.5 m height, 20 m width and 52 m length.

The rock is used as containment structure to withstand pressure rises.

4.7.9. Advantages of the underground siting are considered to be:

- greater safety in case of major hypothetical accidents
- improved protection against external events

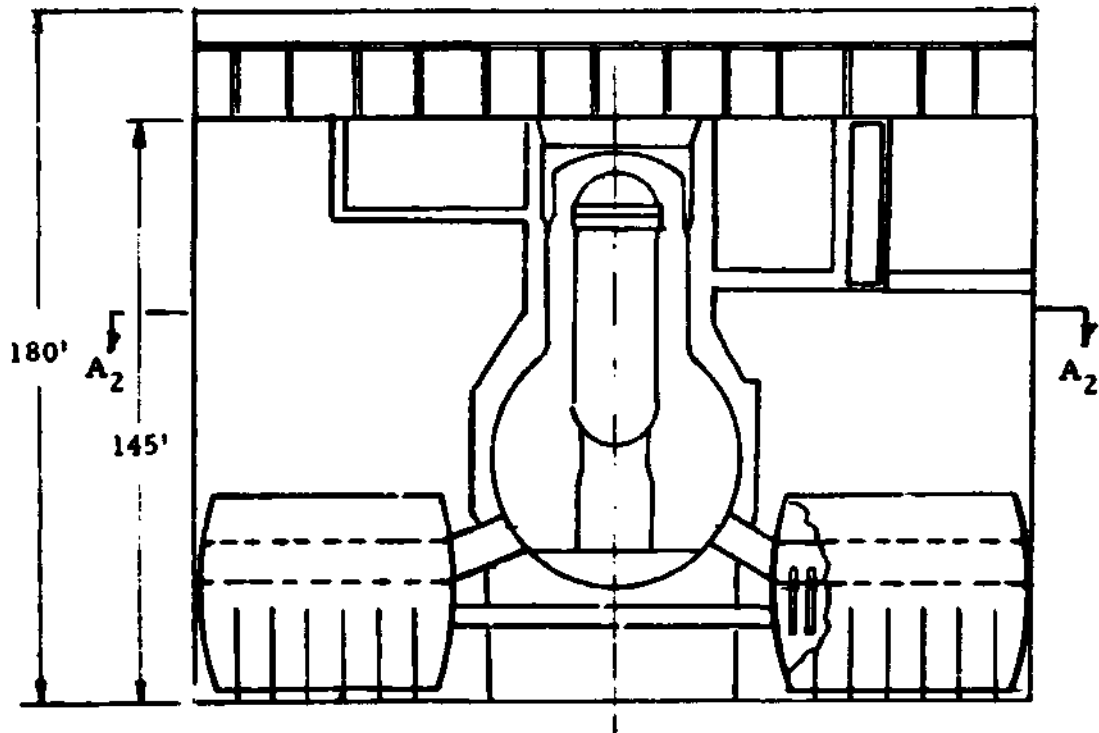

Fig. 4 - 19 Minimum modified BWR reactor cavern: vertical section

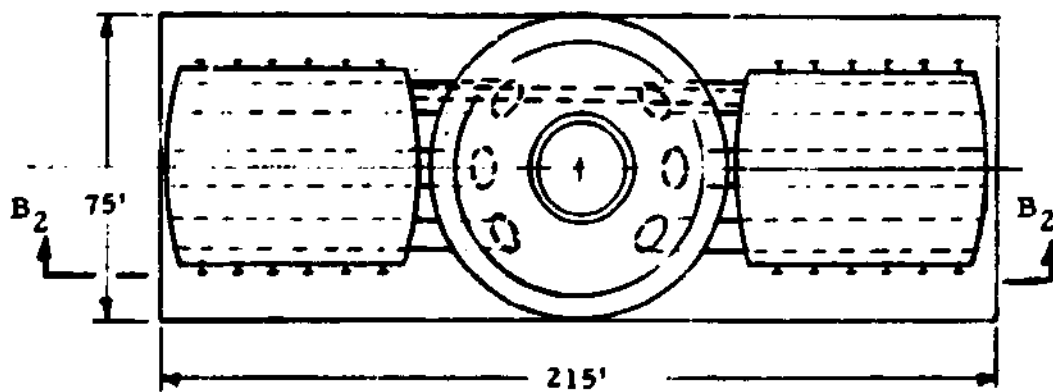

Fig. 4 - 20 Minimum modified BWR reactor cavern: plan

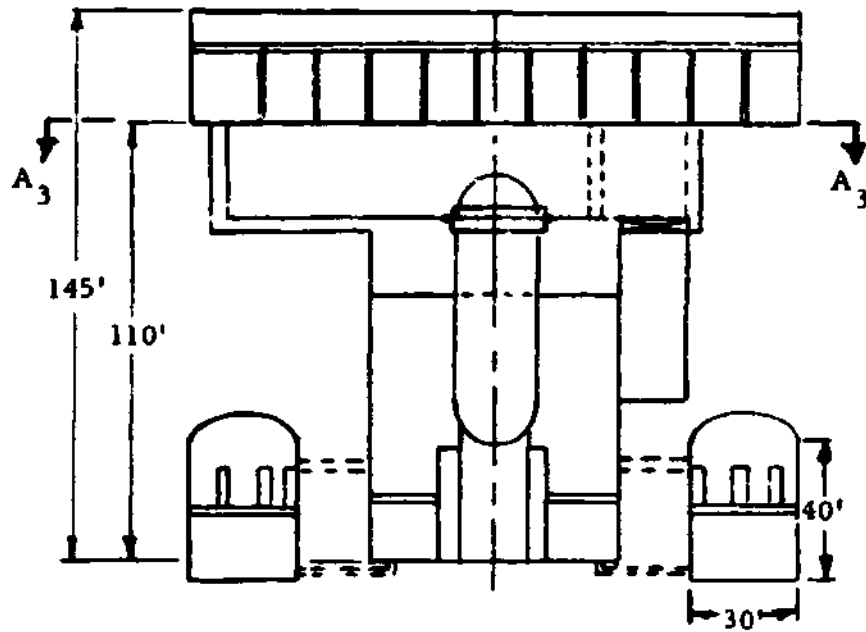

Fig. 4 - 21 Reconfigured BWR reactor cavern: vertical section

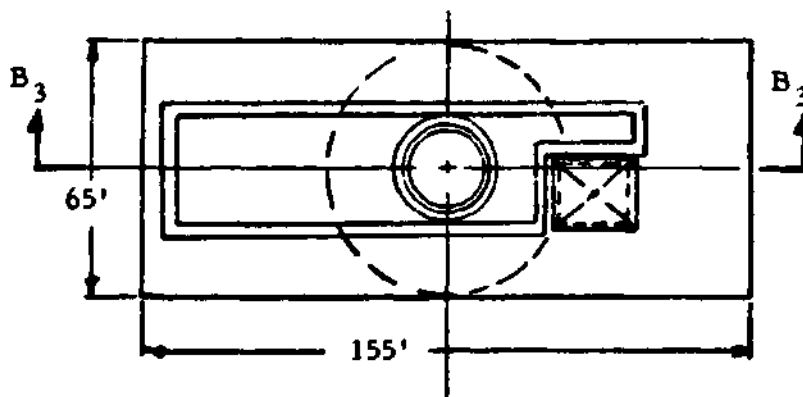
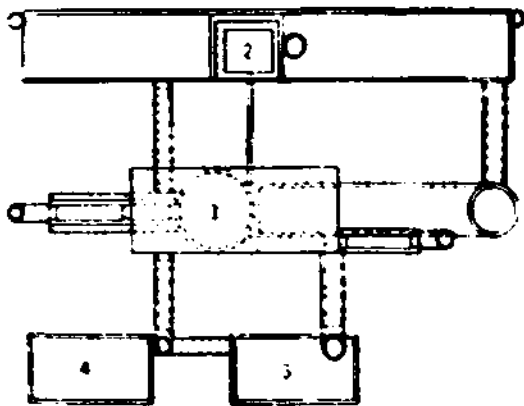
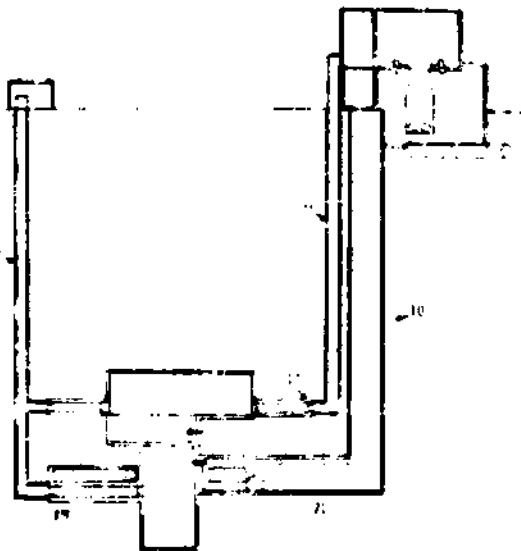

Fig. 4 - 22 Reconfigured BWR reactor cavern: plan



- 1. Reactor chamber
- 2. Nuclear auxiliaries chamber
- 3. ECCS pump chamber
- 4. Relay, logic and switching equipment chamber

Fig. 4 - 25 BWR partially underground: plan



- 10. Main steam and feedwater shaft
- 11. Reactor chamber equipment access shaft
- 12. Reactor chamber personnel access shaft
- 17. Reactor personnel access tunnel
- 18. Reactor equipment access tunnel
- 21. Main steam and feedwater tunnel

Fig. 4 - 26 BWR partially underground: reactor cavern vertical section

- reduction of seismic loadings
- reduced surface area requirements
- improved aesthetics

4.7.10 The cost increase of the underground plants (in 1971 dollars) has been estimated to be between 5 and less than 10 % (\$ 14 - 16/Kw) for plants totally underground and about 4 % (\$ 8 - 9/Kw) for partially buried plants.

4.8. THE LAWRENCE LIVERMORE LABORATORY STUDY

4.8.1. Two reports published by LLL in 1973 and 1974 (Ref. 4 - 12, 4 - 13) suggest the "cut-and-cover" technique for undergrounding a nuclear power plant.

With this technique, massive rock formations are not required: the reactor containment can be constructed in nearly any geological medium with conventional construction techniques. Containment of radioactive material can be best obtained by covering the underground structures with a material having a known and controllable permeability and porosity.

The study focused on the underground siting as a means of eliminating the release of radioactive products to the environment as a result of a major hypothetical accident, an earthquake or some other unusual occurrence.

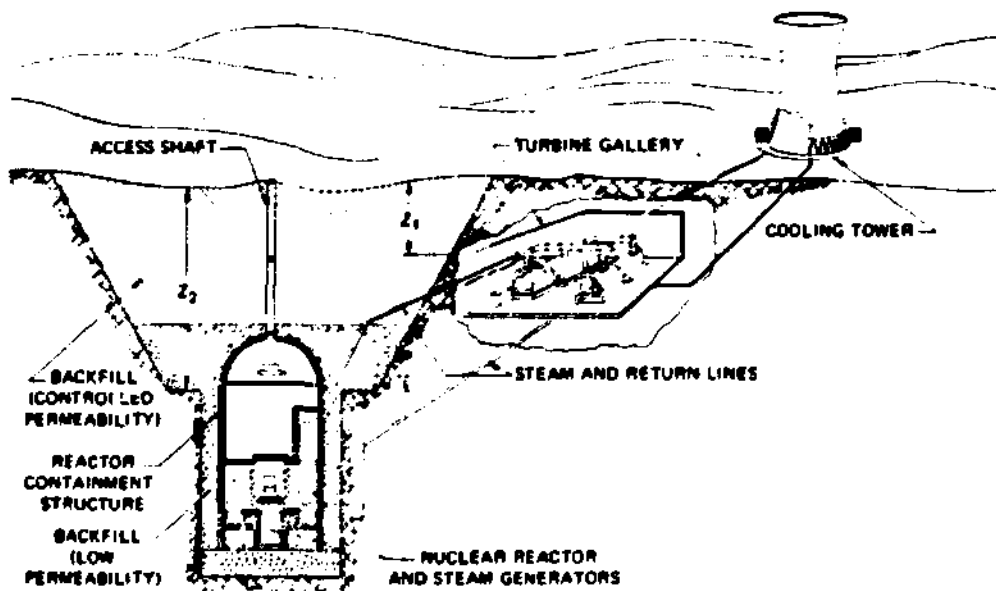

Fig. 4 - 27 LLL Study: plant layout

4.8.2. The study is based on a 1100 MWe PWR. In the proposed concept the NSSS is located underground at a depth of about 100 m.

This depth has been chosen in such a way as to provide a static pressure capable to counterbalance the peak design pressure.

The containment is a concrete cylindrical structure with a dome with an internal diameter of about 28 m and an internal height of about 55 m. The thickness of the cylindrical walls is about 1.5 m.

The turbine building is also located underground but at a different elevation (Fig. 4 - 27).

The containment is connected to the surface through an access shaft for personnel and equipment about 3 m in diameter.

No detailed information regarding the plant layout (as for instance, the location of the auxiliary building or the fuel handling building) is given.

4.8.3. The depth of reactor and turbine burial, the excavation slope and soil type have been taken as variable parameters. Containment structure design, heat and pumping losses according to various elevation differences between reactor and turbine, seismic and overburden effects together with the performances of the backfill as a reservoir for radioactive releases and as a filter and absorber are among the main topics investigated.

In particular:

- no new technologies are required for undergrounding the plant

- the shock stress required to rupture a buried containment doubles as compared with a surface structure
- locating the turbine and related equipment at the reactor level may result in unreasonable operating costs. Therefore, turbine, generator, condenser etc. should be located at or near the surface
- the pressure losses in the steam line are estimated to be less than 1 % of the initial pressure. The heat losses are less than 0.04 % of the gross electrical output under worst-case assumptions
- the static overburden loading produces stresses that are generally much greater than those produced by the examined earthquake loading
- the presence of a low permeability layer over the containment prevents leakage to the atmosphere even under "worst case" conditions
- a serious accident does not present a threat of atmospheric or in situ earth contamination resulting from a complete failure of the reactor containment structure (Ref. 4 - 12)

Based on LLL experience with underground detonations of nuclear devices, the study states that "closure systems for all required penetrations of the reactor structure are entirely practicable" (Ref. 4 - 12)

4.8.4. According to this study the advantages of an underground nuclear power plant are the following:

- extreme protection against tornadoes and falling objects
- improved containment of radioactivity in case of extreme hypothetical accidents
- greater biological shielding
- improved aesthetics
- possibility of urban siting with savings in power transmission costs.

Moreover, if compared with a rock cavity plant, this type of siting has a unique advantage: the permeability and the porosity of the backfill material can be controlled in a reliable manner.

4.8.5. The cost penalties associated with the pit excavation and an appropriate reactor containment structure are estimated to be considerably less than 5 % of the cost of an equivalent surface 1100 MWe plant.

4.9. THE CALIFORNIA POWER PLANT SITING STUDY

4.9.1. This general study on the siting of electric power generating plants in coastal zones or in inland locations in California was performed in 1973 by Holmes & Narver Inc. for the State's Resources Agency (Ref. 4 - 14).

The study has identified regions acceptable for three potential siting concepts for nuclear power plants: above ground, underground and offshore. Site characteristics peculiar to these concept options have also been identified.

The following site characteristics have been taken into account for the underground siting:

- massive igneous rock, in a relief exceeding 90 m, within 1 to 1 1/2 miles from the coast
- massive sedimentary rock, in a relief exceeding 90 m, within 1 to 1 1/2 miles from the coast
- unconsolidated materials, on a low elevation beach, near the coast
- nonmassive or poorly cemented rock in a hill within 1 to 1 1/2 miles from the coast
- massive igneous or sedimentary rock formations in a faulted zone, in a relief exceeding 90 m within 1 to 1 1/2 miles from the coast.

Both mined rock cavities (with horizontal access) and the cut-and-cover technique have been considered.

For the underground siting of nuclear power plants, the study is based on a 1100 MWe LWR. All plant components and equipment are similar to those of an above ground plant.

4.9.2. The plant located in massive igneous rock is, with the exception of the pumping station and some vent structures, completely located underground.

The rock overburden is 45 to 60 m thick to ensure a sufficient safety factor against atmospheric releases.

The plant is constructed in six underground caverns (Fig. 4 - 28) housing respectively the reactor containment, the fuel and auxiliary building, the turbine-generator building, the electrical building, the control building and the administration building.

The containment cavity has a span of about 43 m and is lined with a concrete layer about 30 cm thick and with steel plates 6 mm thick.

Piping and penetrations as well as the equipment hatch have been relocated around the containment mainly to minimize connections length.

The fuel handling building and the auxiliary building are located in the same cavern. Components and equipment are the same as in the reference plant also if they may be arranged differently.

The turbine-generator hall has a span of about 40 m. The turbogroup is, with minor exceptions, (as the relocation of some equipment to reduce the cavern span) of conventional design. The length of this cavern has been extended about 35 m to accommodate various items as two diesel generators with fuel tanks, the component cooling system heat exchangers, batteries, etc.

Access to the underground plant is through five access roads (Fig. 4 - 28). Five plant ventilation structures are the

other plant connections with the atmosphere. This layout is similar to that of the plant located in massive sedimentary rock.

4.9.3. The plant in unconsolidated materials is based mainly on the Bechtel Study described in § 4 - 3.

The entire plant will be buried with a cover about 1 m thick over all buildings in a large pit backfilled with the excavated soil (Fig. 4 - 29).

The plant is constructed with all equipment and systems normally found in the containment, fuel building, auxiliary building and control room located in one large cylindrical structure 70 m in diameter and about 72 m high.

The offices and workshop building and the electrical building are also cylindrical in shape to better resist soil pressure. The turbine-generator building is rectangular because of constraints imposed by the equipment.

The buildings are separated a minimum of 35 m to allow enough room for the freeze wall construction operations.

Access between buildings is through 6 m diameter reinforced concrete tunnels. The main access tunnel is 9 m in diameter.

4.9.4. The plant built in nonmassive and poorly cemented materials is represented in Fig. 4 - 30. The facility is built with the cut-and-cover technique and has a layout similar to the plant in unconsolidated materials, previously described.

Also in this case the backfill thickness is about 1 m.

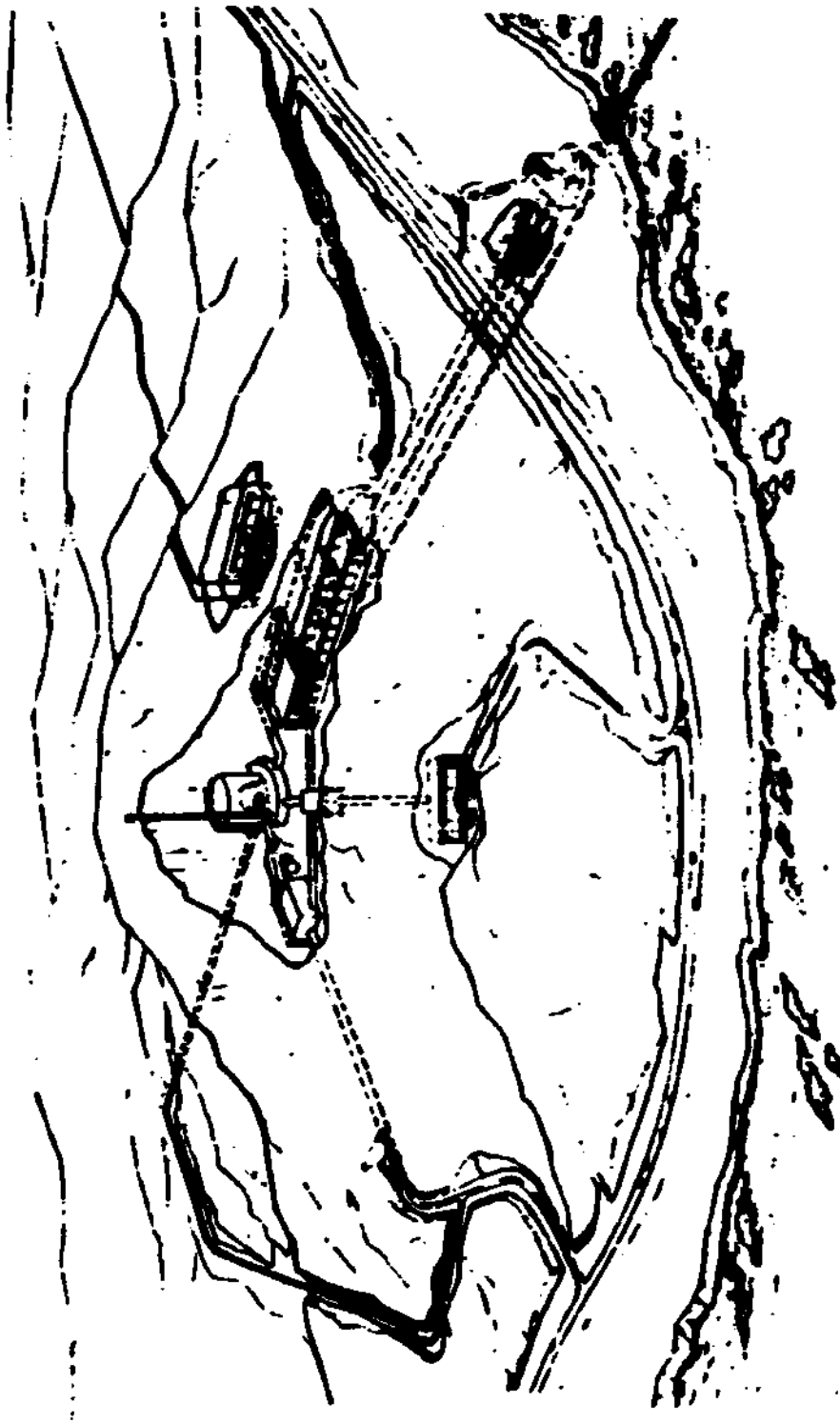

Fig. 4 - 28 Underground plant in massive igneous rock

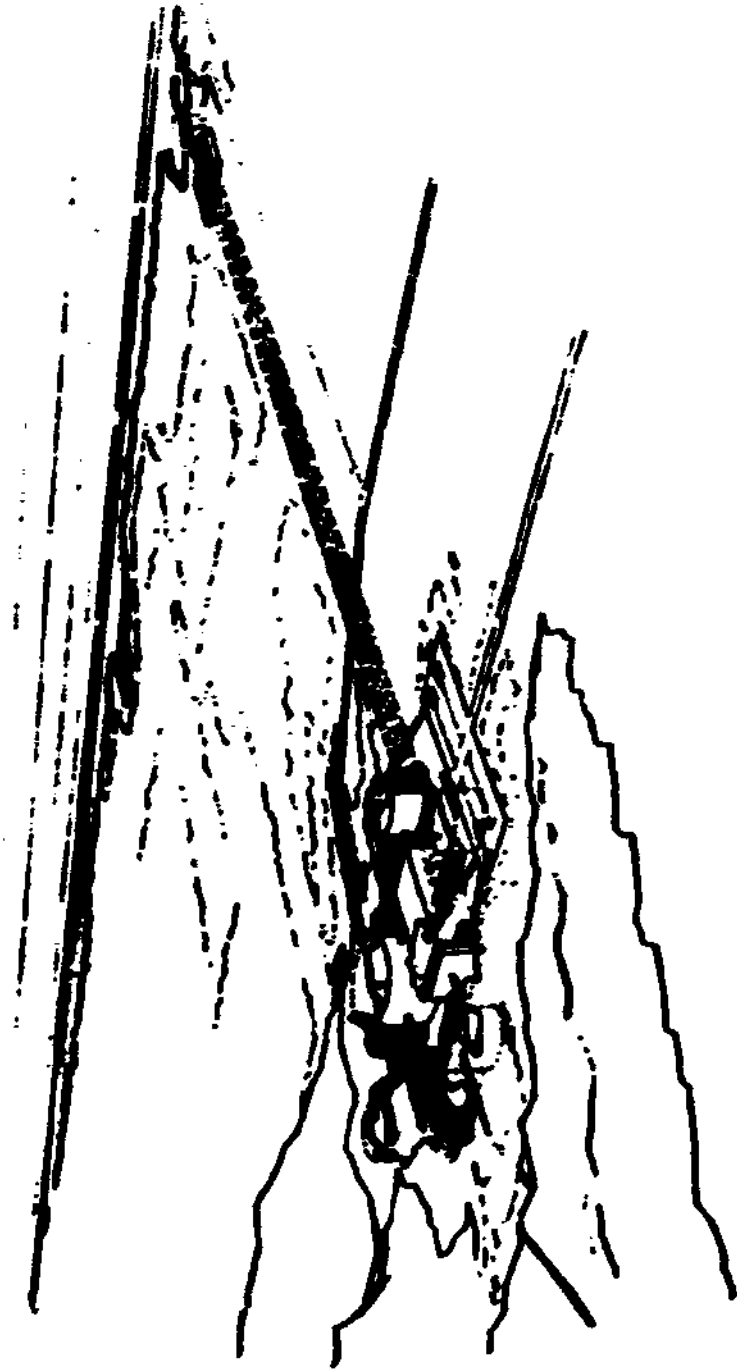

Fig. 4 - 29 Underground plant in unconsolidated materials

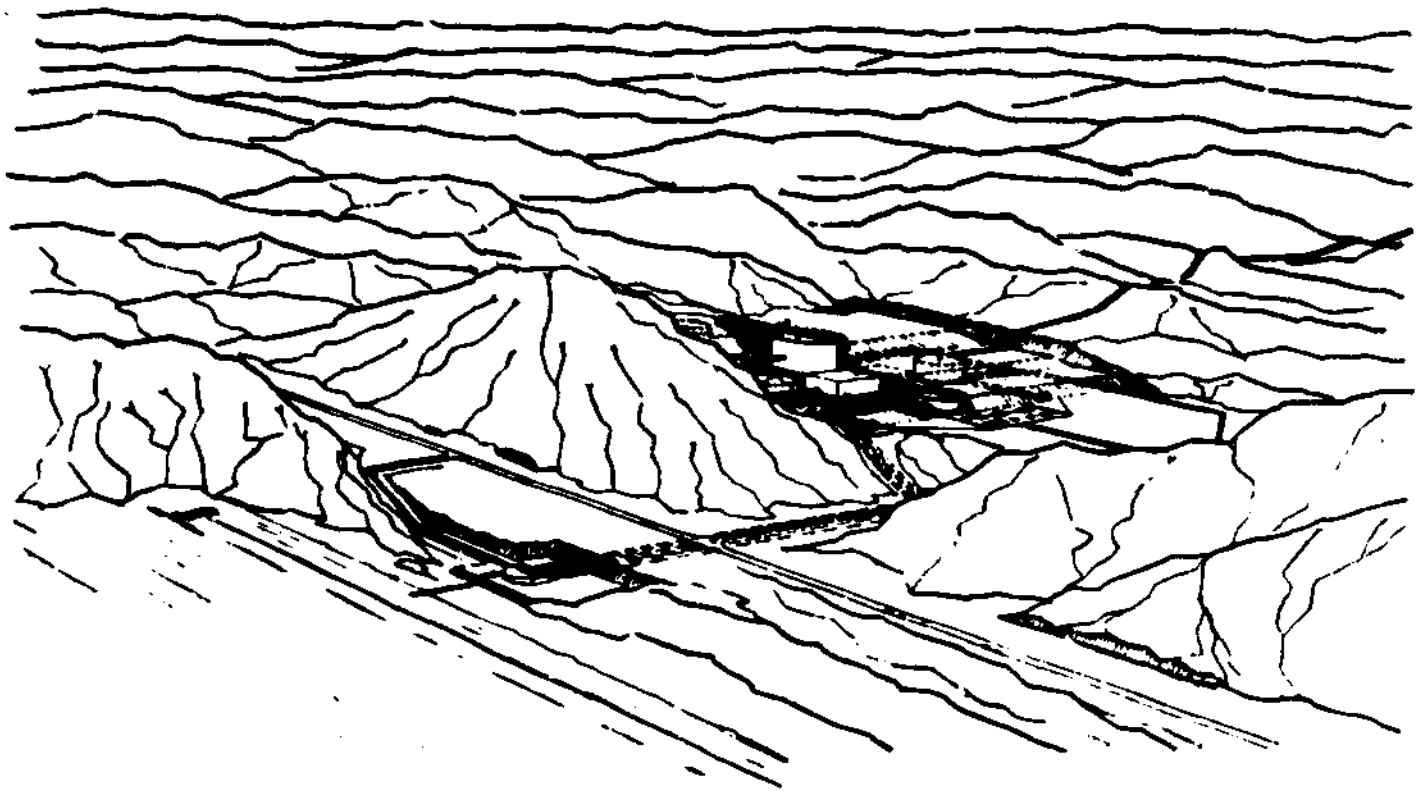

Fig. 4 - 30 Underground plant in nonmassive poorly cemented materials

- 4.9.5. The layout of the plant in massive faulted rock is similar to that of the plant located in massive igneous or sedimentary rock.

In this case, however, the rock is not used as the outer buildings wall. All buildings are in fact constructed in underground caverns in which the rock domes and walls are excavated to provide a rattlespace around all buildings and lines to prevent damages from shifting foundations in the event of a fault dislocation.

- 4.9.6. The conclusions of the study are that the technologies required for design, excavation, construction and operation of an underground nuclear power plant are within the present state of the art.

For the rock cavity plants, advantages are the protection from surface influences, the additional containment provided by the rock, the reduction of ground motion in case of an earthquake.

Disadvantages are considered to be the longer construction time, the increased costs, the longer piping and cables runs and the increased ventilation requirements.

For the pit sited plants the potential advantages are considered to be the same as for the rock cavity plants. An additional advantage for this type of siting is the greater number of potential sites.

The disadvantages are mainly related to the need for strong structures to withstand the backfill loads.

- 4.9.7. The study has made an evaluation of the siting concepts taking into account the following main factors: cost factors, environmental impact, feasibility and risk.

The following table gives the overall acceptability of each siting alternative examined by the study.

Title	Acceptability Values
Aboveground-Island	0.779
Aboveground-Floating, Lagoon	0.761
Aboveground-Hillside	0.756
Aboveground-Low Profile	0.674
Aboveground-Coastal	0.657
Offshore-Floating, Deep	0.649
Underground-Nonmassive, Poorly Cemented Materials	0.642
Offshore-Artificial Island	0.637
Offshore-Floating, Shallow	0.636
Offshore-Tuned Sphere	0.617
Underground-Massive Sedimentary Rock	0.603
Offshore-Natural Island	0.581
Offshore-Undersea	0.549
Underground-Massive Igneous Rock	0.540
Underground-Unconsolidated Materials, Beach	0.522
Offshore-Seabed	0.502
Underground-Massive Rock, Faulted	0.494

Table 4 - 1 Overall acceptability of the siting concept

4.10. THE SANDIA STUDY

4.10.1. This general study, published in 1977, has been performed by Sandia Laboratories for the Nuclear Regulatory Commission to investigate the potential of improving nuclear safety by siting nuclear power plants underground (Ref. 4 - 15).

For this investigation two underground siting alternatives have been taken into account: the rock cavity alternative and the pit siting.

The main factors evaluated in the study which takes into account three different representative sites are: containment of radioactive materials, transport of groundwater contamination, seismic vulnerability, external protection, plant security, feasibility, operational considerations, costs and availability of sites in USA with the required characteristics for the investigated siting concepts.

4.10.2. The study is based on a 1100 MWe PWR. The main assumptions made for this study are the following:

- in the underground location, the equipment and layout of the containment building are the same as in the reference surface plant
- the volume of the underground containment cavity is the same as that of a conventional surface containment. For rock media in which this opening can be constructed as free-standing cavity, the rock walls are assumed to satisfy containment requirements

- the power conversion system is of standard configuration. The condenser however may be designed for high pressure.
- the depth of burial is assumed to be about 30 m from the surface to the top of the containment dome. This depth is considered to be minimal to develop a hydrostatic pressure capable to counteract the DBA peak pressure.

4.10.3. The study refers to different concepts namely:

- a rock cavity plant with vertical access
- a rock cavity plant with horizontal access
- a pit sited plant

For each concept two locations for the power conversion system have been considered: at or near the surface and at or near the reactor building elevation (Fig. 4 - 31 to 4 - 34).

Although two of the main underground siting alternatives have been examined, the development of specific plant layouts has been considered to be beyond the scope of the study.

Therefore, as a result, the conclusions and the considerations of this investigation on the potential benefits and penalties of the underground siting are necessarily of a very general nature being based just on the siting concepts.

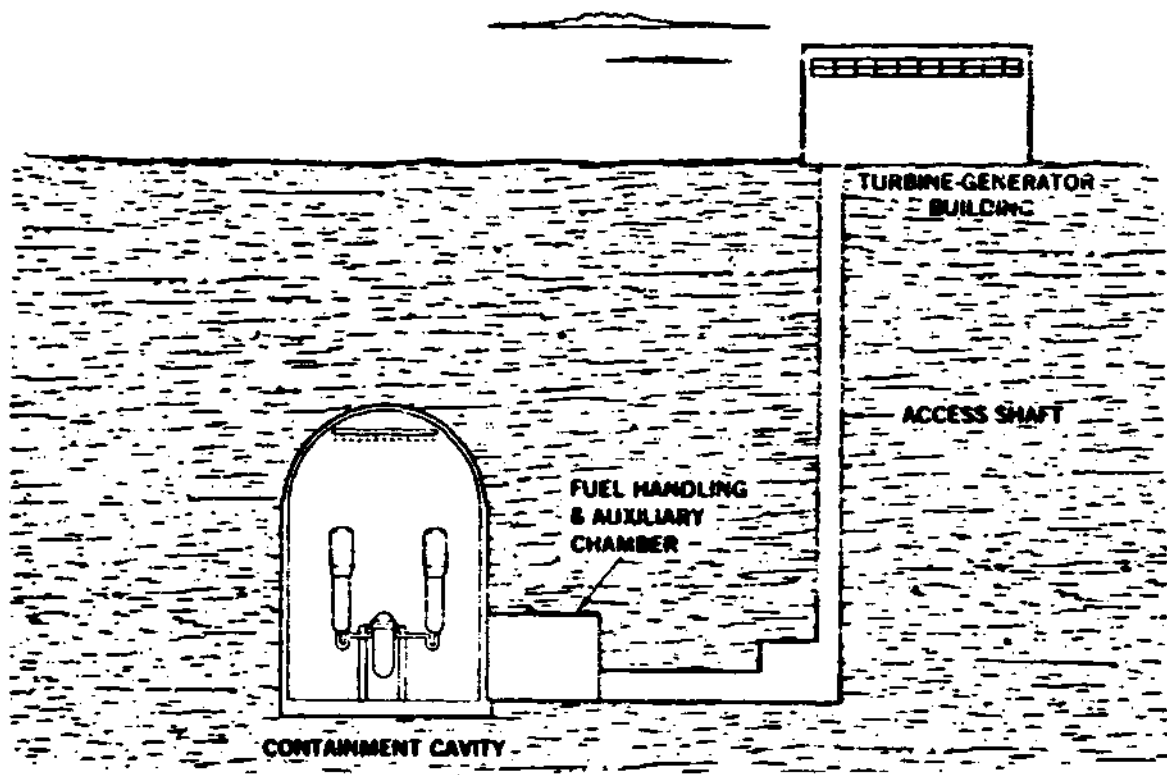

Fig. 4 - 31 Rock cavity plant with vertical access: power conversion system on the surface

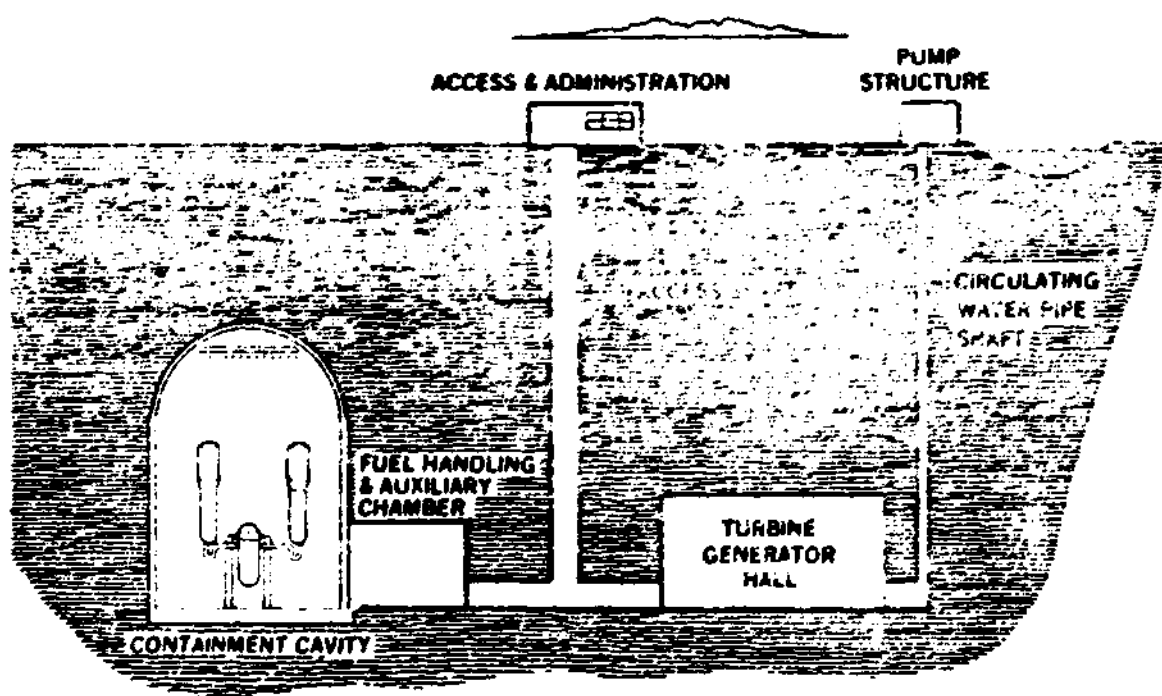

Fig. 4 - 32 Rock cavity plant with vertical access: power conversion system underground

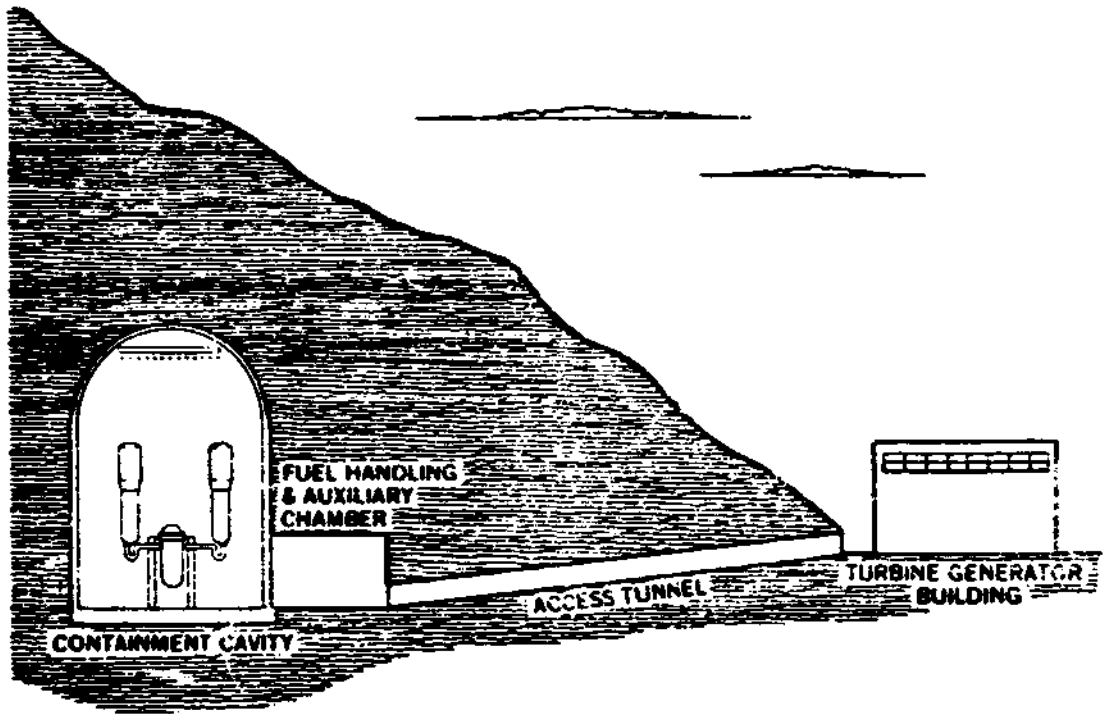

Fig. 4 - 33 Rock cavity plant with horizontal access

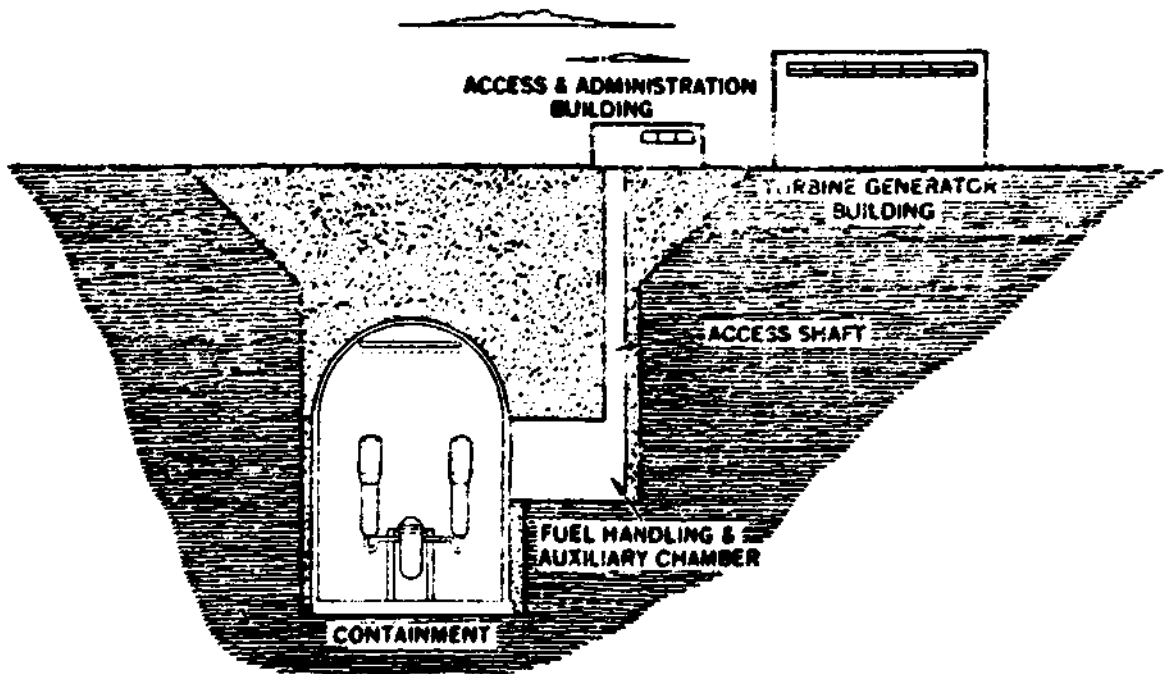

Fig. 4 - 34 Pit siting

4.10.4. The main conclusions of the study are that:

- the underground siting has negligible advantages over surface siting in case of accidents which do not involve core meltdown
- the underground siting provides an additional containment in case of core meltdown accidents if a reliable sealing of penetrations and accesses can be provided. Otherwise, the release in the atmosphere and the public consequence would be similar to those of an equivalent accident in a surface plant with containment isolation failure
- groundwater contamination in case of core meltdown may be more severe underground than above ground because of the greater likelihood of escape of contaminated sump water
- there may be a modest reduction in seismic vulnerability due to the underground siting at a reasonable depth of burial
- the underground location provides an increased protection against external events, including aircraft crashes and acts of war. However, underground plants show an increased vulnerability to flooding
- the underground siting provides a negligible increased sabotage protection against covert threats or against low/medium strength overt forceful threats. Increased protection is, instead, provided against high strength overt threats and external attacks by munitions. These advantages are however offset by a reduced flexibility in plant recovery and damage control operation

- there are no technical problems capable to prevent the underground siting of a nuclear power plant.

Moreover, according to the study, the underground siting would complicate maintenance, repair and inspection of equipment and would hamper spent-fuel handling. Personnel safety may be a problem especially during an emergency.

- 4.10.5. An underground plant is more expensive than an equivalent surface plant because of increased costs of construction, equipment and interest from extended construction schedules. According to the Sandia study, the cost increase is between 20 and 40 % of the cost of an equivalent above ground plant.
- 4.10.6. Alternatives to deep burial have also been discussed as well as possible modifications of the design of surface plants to obtain some of the potential benefits of the underground siting (i.e. improved containment of core meltdown accidents). The controlled venting of the containment building is considered to be quite effective.

4.11. THE CALIFORNIA ENERGY COMMISSION STUDY

4.11.1. In June 1976, the California Legislature passed a law (AB 2821) that required the California Energy Commission (CEC) to complete within one year "a study of the necessity for, and effectiveness of and economic feasibility of undergrounding and berm containment of nuclear reactors".

The CEC study has therefore examined two underground siting concepts: the berm containment (pit siting) and the rock cavity plant (Ref. 4 - 16, 4 - 17).

The berm containment study, as well as the rock cavity study, are based on a 1300 MWe PWR as described in the Westinghouse Resar 414. A BWR concept has also been examined in some detail.

4.11.2. The berm contained underground plant is represented in Fig. 4 - 35 and 4 - 36.

A large dome-shaped structure encloses a separate reactor containment building. This structure is semi embedded in a shallow excavation and is covered with soil removed from the pit.

This design has been chosen to minimize the price of the excavation and of the backfill.

The configuration of the external structure with its cylindrical cross section and hemispherical dome was selected on the basis of its efficiency in withstanding the static loads of the backfill and in resisting the large

seismic loads associated with the 0.5 g peak surface accelerations.

A free-standing containment building is entirely enclosed within the dome-shaped external construction resting on a common mat foundation structure.

The turbogroup and associated systems are located above ground.

- 4.11.3. The dimensions of the external structure (about 94 m i.d., about 70 m internal height with a wall thickness in the cylindrical section of 4.9 m and 1.9 m at the apex of the dome) have been chosen in such a way as to house all equipment normally located in the auxiliary building and in the fuel handling building.

Sufficient space has also been provided within this structure to house the control room and related cables.

Piping, cabling and ventilation lines between the surface and the underground structures have been provided through tunnels connecting the external auxiliary structure with the turbine-generator building above ground.

Penetrations and doors for these tunnels are provided with seals to prevent radioactive leakages from the external structure in case of a failure of the reactor containment.

A fuel handling and storage facility for both fresh and spent fuel is located in the underground auxiliary building. Access for fuel shipment has been provided by means of a short tunnel.

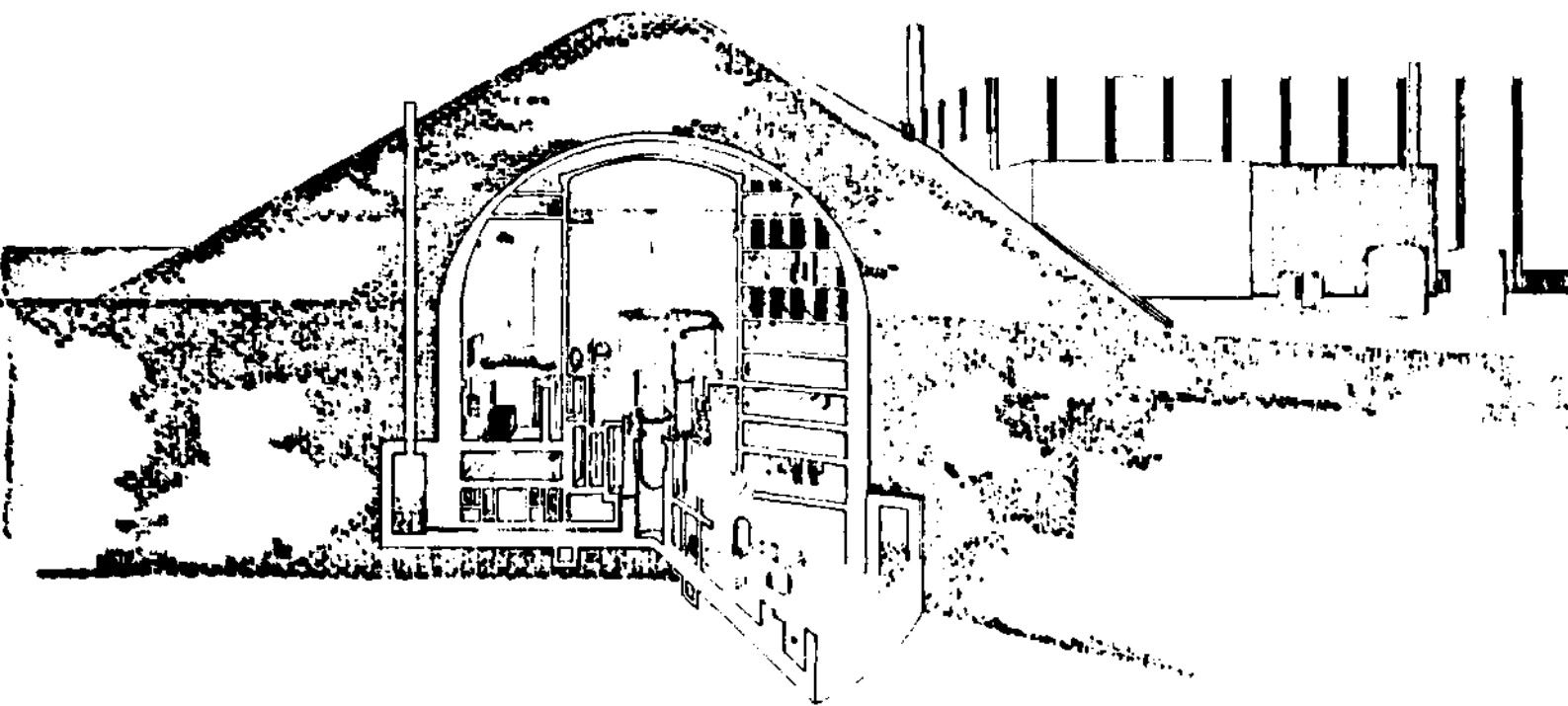

Fig. 4 - 35 Outline drawing of the CEC berm contained underground p

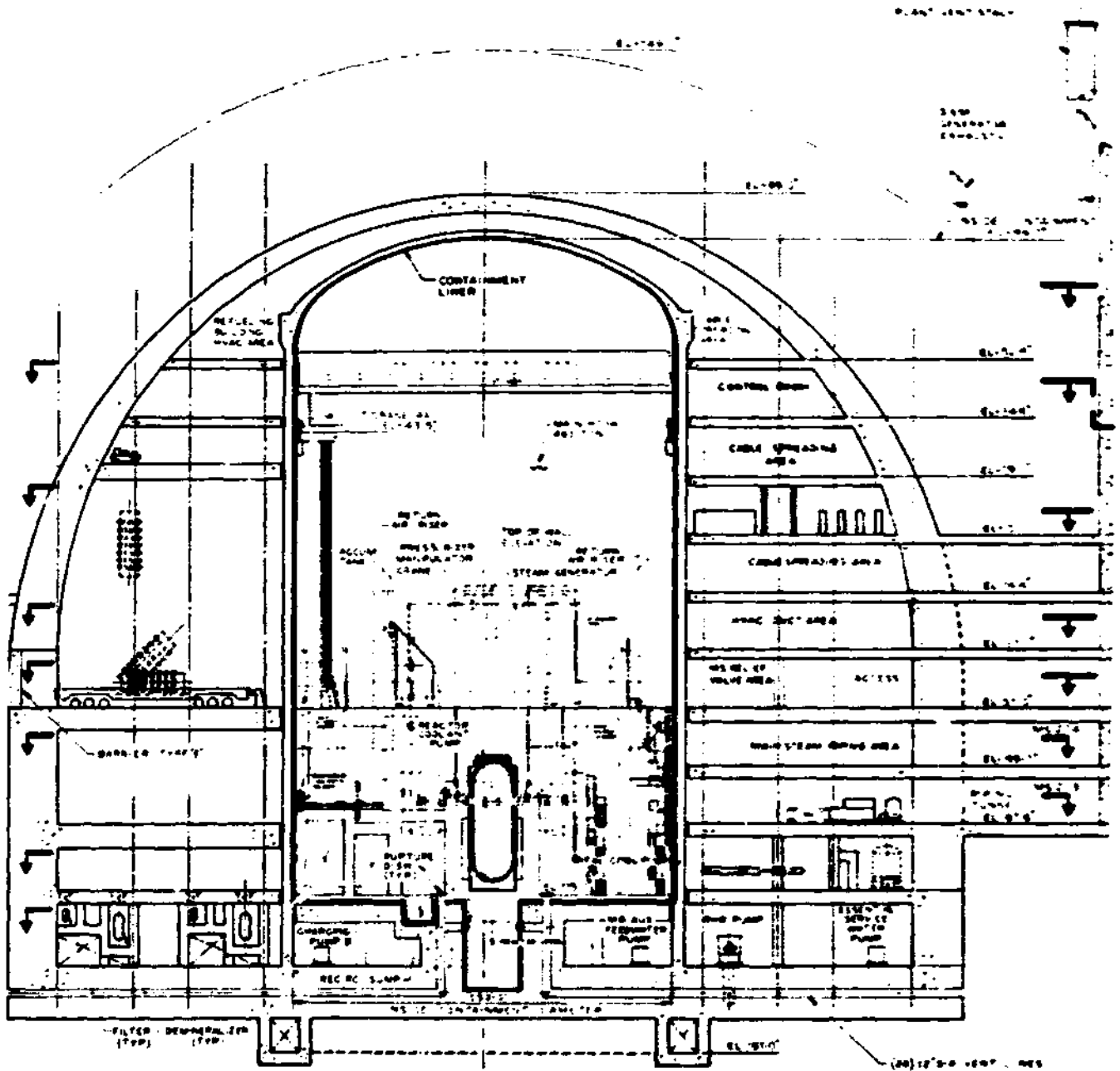

Fig. 4 - 36 CEC study. Berm contained plant: vertical section

The reactor containment structure has not been significantly modified.

A modest reduction of the seismic loads in the underground location has allowed the underground containment to be designed with slightly thinner walls (about 1.3 m at the cylindrical section and 0.9 m at the apex of the dome instead of 1.8 m and 1.2 m respectively).

The backfill thickness is about 15 m.

4.11.4. A mitigation system for major hypothetical accidents has been proposed.

24 pipes about 30 cm in diameter are routed from the lower levels of the reactor containment building, through the massive concrete base mat (about 4.9 m thick) to a concrete header structure completely encircling the outside of the auxiliary structure.

Three parallel connected burst disks isolate the reactor containment from each of the 24 pipes leading to the header structure.

The header contains a rock heat sink and a filter medium (gravel and stones) for the gases and vapours released in a major accident. A vent stack containing additional filtering materials connects the underground rock-bed filled header to the surface.

This mitigation system has two main functions. The first is to prevent an excessive pressure and temperature build-up in the containment building avoiding in this way an uncontrollable failure of the containment structure.

The second function is to provide a controlled release path for the radioactive gases and vapours to the atmosphere.

Another concept in which the radioactive release is led to an expansion volume in a rock bed around the lower part of the auxiliary building has also been proposed.

4.11.5. The plant in rock cavities is also based on a Westinghouse 1300 MWe PWR

This plant, of the hillside type, has also the turbogroup located underground (Fig. 11 - 37 and 11 - 38).

The plant is located in four major caverns oriented parallel to a postulated tectonic stress field within the rock (Fig. 11 - 37). Every cavern is separated from another by a distance about equal to the largest adjacent cavity span (about 30 m).

The reactor cavern is located about 250 m inside the hill housing the plant with the operating floor at about the same level as the external grade at the main access.

At this location, the reactor cavern is about under 90 m of rock. About 30 m are supposed to be weathered rock and the remaining 60 m to be solid, competent rock.

The dimensions of this rectangular cavity with an arched roof are about 65 m height, 30 m width and 58 m length. Even if built as a freestanding cavity, the cavern is lined with concrete about 1.0 m thick and with steel plates. In case of an accident the reactor cavern would function as the primary containment structure.

The turbine-generator and transformer caverns are located

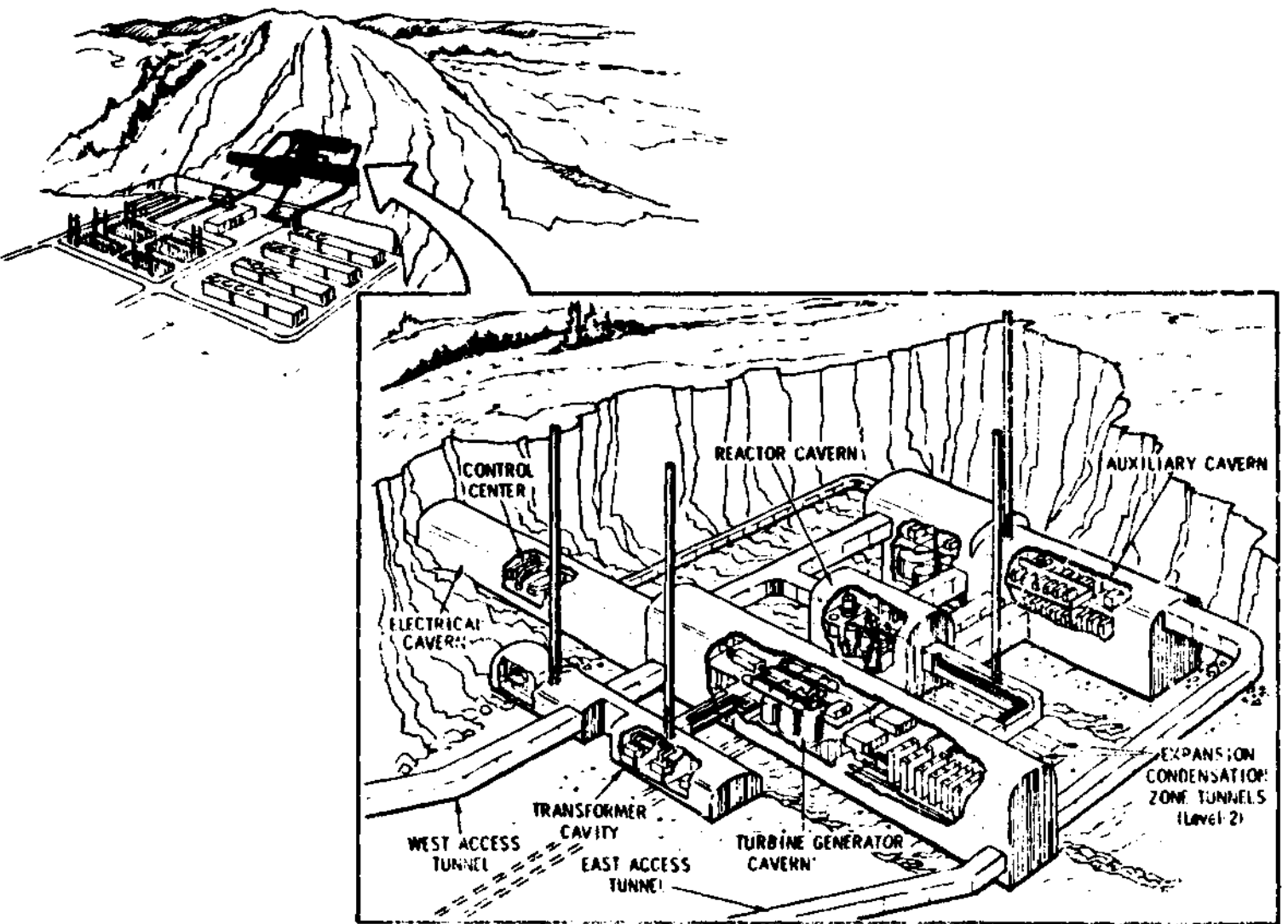

Fig. 4 - 37 Cutaway drawing of the CEC rock cavity plant

near the access to the underground facility in order to reduce the length of condenser cooling water lines and the length of electrical power cabling to the switchyard. The turbine cavern is rectangular in shape, 52 m high, 28 m wide and 192 m long.

In order to reduce the cavern span requirements the feed-water heaters have been grouped into an axial extension of the turbine generator cavern.

The plant control room is located at the other end of the turbine hall, to retain control and monitoring circuits lengths which are comparable to those of a surface plant.

The auxiliary cavern houses the rad-waste processing equipment, new and spent fuel storage facilities, the CVCS etc.

This cavern (57 m high, 28 m wide and 140 m long) is located at a lower elevation than the reactor cavern to ensure that the head for the ESS circulating pumps will be the same as in a surface plant.

- 4.11.6. An accident mitigation system similar to that of the pit siting concept has been proposed also for the rock cavity alternative.

Two tunnels, partly filled with crushed rock from the excavation, extending to the right side of the reactor cavern, provide expansion volumes and heat sink.

These tunnels are connected to the reactor cavern through pressure and temperature sensitive valves and to the atmosphere through a vertical shaft and a stack.

In this way, in case of a major hypothetical accident, a reduction in the reactor containment cavern pressure can be achieved.

A system in which the gases expand and cool through the tunnels and then leak into the low-permeability rock in which the plant is located has also been taken into account.

4.11.7. The main conclusions of the study are that

- conventional construction techniques can be used and no technological restrictions have been found for the construction of both siting alternatives
- no problems are foreseen for what concerns plant operation and maintenance
- some seismic benefits are achievable with underground construction. Amplifications of seismically induced motions for the underground structures have been found to be substantially reduced. Therefore, some benefits in seismic design requirements for equipment can be expected
- the proposed accident mitigation systems have been found to be highly effective to reduce public health consequences.

4.11.8. The percentage cost increases over the reference surface plant have been estimated, including 9 % escalation, to be approximately 14 % for the pit siting and 25 % for the rock cavity alternative.

The construction time has been estimated to require 19 months longer for the rock cavity plant and 22 months for the pit siting.

4.12. COMPARISON AMONG THE STUDIES

4.12.1. Many of the studies previously described are detailed investigations meant to assess and to evaluate the feasibility, the advantages, the disadvantages and the economical penalties of the underground siting. Some of them are however more general studies meant either to evaluate novel siting alternatives for nuclear power plants or to investigate the safety potential of this type of siting in comparison with surface plants.

4.12.2. All the three main variations of the underground siting concept have been examined. The surface mounded plant, the rock cavity plant (with both the "hillside" and the "deep below the surface" alternatives) and the pit siting for both totally or semi-embedded plants.

For these alternatives, plants totally and partially underground have been investigated and, in most cases, detailed layouts have been developed.

All these studies, with the exception of a 1000 MWe LMFBR, are based on light water reactors rated 1000 - 1300 MWe.

The main characteristics of these investigations are summarized in Tab. 4 - 2 to 4 - 4.

4.12.3. According to the majority of these studies, the potential advantages of the underground siting are:

- the additional level of containment because of the surrounding soil or rock, in case of major hypothetical accidents

- a better protection against external events, natural and man related, including sabotage
- the modified and lessened seismic loading
- an improved biological protection
- the possibility of siting the plant in highly populated areas (urban siting) with consequent reduction of power transmission costs
- reduced surface area requirements
- improved public acceptance
- improved aesthetics

Moreover the plant decommissioning may be simplified.

All the studies examined agree that no new technologies are required for undergrounding a nuclear power plant.

4.12.4. The main disadvantages of the underground siting are instead considered to be:

- the longer construction time
- the higher costs
- problems related with the excavation of caverns with spans larger than 30 - 35 m.

4.12.5. Some of the potential advantages and disadvantages of the pit siting, in comparison with the rock cavity alternative, have also been identified.

Among the advantages there is:

- the possibility to control the permeability and porosity of the medium surrounding the plant in a reliable way, and
- the greater number of potential sites available.

Disadvantages are instead considered to be:

- the strong structures required to withstand the backfill loadings
- the longer construction time (and sometimes the higher costs) as compared with an equivalent rock cavity plant.

4.13. CONCLUDING REMARKS

- 4.13.1. The common motivation for the majority of the studies examined in the preceding paragraphs is to evaluate the feasibility, the effectiveness and the costs of the underground siting.

A summary of the most significant characteristics of these studies is given in Tab. 4 - 2 to 4 - 4.

- 4.13.2. All the main alternatives of the underground siting with their main variations and combinations have been investigated and plant layouts, sometimes very detailed, have been developed.

Modifications and repackaging of the nuclear steam supply system or of other vital equipment have been suggested in some studies both to reduce the cavern spans within the limits of already existing man made cavities and to better fit the cavern shape.

Comparison with surface plants have been made, not only for what concerns the potential safety advantages or disadvantages of the siting concept, but also for what concerns cost penalties and increased construction schedule.

The cost increase ranges from 4 % (Ref. 4 - 4) to 50 and 60 % (Ref. 4 - 3, 4 - 14). The construction time, on the average, is estimated to be 18 to 30 months longer than for an equivalent surface plant.

STUDY	YEAR	REACTOR TYPE & RATING	PLANT CONFIGURATION	CONTAINMENT TYPE & DIMENSIONS (l x v x h) m	COST INCREASE VS A SURFACE PLANT	INC. CONS. TIME
HARBA ENGN.	1970	twin BWR 1100 MWe	deep below the surface plant partially underground	rectangular rock excavation 168 x 25 x 73	\$ 10/kW	18
BECHTEL POWER CORP.	1970	PWR 1100 MWe	plant in a shallow excavation reactor building roof at ground level	double cylinder structure Ø = 70 m h = 72 m	50 %	
ACRES- UNITED ENGN.	1970- 1972	PWR 1000 MWe	deep below the sur- face plant totally underground	cylindrical rock excavation lined with concrete and steel Ø = 42 m h = 70 m	5 - 20 %	
STONE & WEBSTER	1971	BWR 1000 - 1500 MWe	deep below the surface plant totally underground	cylindrical rock excavation Ø = 46 m h = 73 m	modest amount	
			near surface plant (cut-and-cover) partially underground			
CLINCH VALLEY	1972	LMFBR 1000 MWe	surface mounded plant	cylindrical concrete structure Ø = 30 m h = 48 m		

Table 4 - 2 Some characteristics of the main american studies (Ref. 4)

STUDY	YEAR	SEALED TYPE & BASIS	PLANT CONSTRUCTION	CONTAINMENT TYPE & DIMENSIONS (L x W x H) m	PERCENT INCREASE TO A SURFACE PLANT	INCREASE IN OPERATING TIME (%)
APP - A B SURFACE PLANT	1971	SWR 1.5 MW	deep below the surface plant	rectangular cavern 40 x 12 x 4	100 - 100% 100 - 100%	
		SWR (modified) 1.5 MW	site near the ocean coast in four principal underground cavities	rectangular cavern 40 x 12 x 4		
		SWR rectangular 1.5 MW	totally underground	rock cavity 40 x 12 x 4		
APP - A B SURFACE PLANT	1973	SWR 1.5 MW, reconfigured	deep below the surface plant partially underground	rock cavity 40 x 12 x 4	100 - 100%	
		SWR 1.5 MW	deep below the surface plant partially underground	rectangular rock cavity 40 x 12 x 4		
APP - A B SURFACE PLANT	1974-1976	SWR 1.5 MW	out-air-covered partially underground	cylindrical concrete structure with a dome A ₁ = 10 m, h = 10 m	100 - 100%	

Table 4 - 3 Some characteristics of the main american studies (continued)

STUDY	YEAR	REACTOR TYPE & RATING	PLANT CONFIGURATION	CONTAINMENT TYPE & DIMENSIONS (l x v x h) m	COST INCREASE VS A SURFACE PLANT	INC CONS TIME
CALIFORNIA POWER PLANT SITING (HOLMES & HARVER)	1973	LWR 1100 MWe	hillside plant in rock cavities totally underground	cylindrical rock cavity lined with concrete & steel $\phi = 43$ m	19 %	up
			plant in a shallow excavation totally underground	cylindrical concrete structure $\phi = 70$ m h = 72 m	60 %	
			cut-and-cover totally underground	cylindrical concrete structure $\phi = 70$ m h = 72 m	20 %	1
SANDIA	1977	PWR 1100 MWe	rock cavity plants and a pit sited plant totally or partially underground	cylindrical structure with a dome $\phi = 42$ m h = 58 m	20 - 40 %	
CEC	1978	PWR 1300 MWe	cut-and-cover semi-embedded partially underground	cylindrical structure within a dome shaped structure $\phi_j = 46$ m h _j = 68 m	14 %	
			hillside plant in rock cavities totally underground	rectangular rock cavity excavation 58 x 30 x 65	25 %	

Table 4 - 4 Some characteristics of the main american studies (cont)

References

- 4-1 F.C. Rogers
Underground nuclear power plants: environmental
and economic aspects
Nuclear News, May 1971
- 4-2 F.C. Rogers
Underground siting of nuclear power plants
Trans. Am. Nucl. Soc. 15 (Suppl. 2) 1972
- 4-3 F.J. Fogarty et al
Design concept for an underground nuclear generating
station at a coastal urban site
Proc. Amerc. Power Conf. 35 (1973)
- 4-4 Review of underground siting of nuclear power plants
UEC-AEC-740107, January 1974
- 4-5 G. Yedigarglu, S.A. Anderson
Novel siting solutions for nuclear power plants
Nuclear Safety, Vol 15, No 6, Nov. Dec. 1974
- 4-6 J.M. Crowley et al
Underground nuclear plant siting: a technical and
safety assessment
Nuclear Safety, Vol 15, No 5, Sept. Oct. 1974
- 4-7 D.R. McCreath
Layout considerations for underground siting.
Lecture for the conference on novel siting solution
for nuclear power plants
University of California, Berkeley, Nov. 8-9, 1973
-

- 4-8 W.F. Swiger
Can we place nuclear power plants underground ?
Geology. Soc. of America, Washington D.C.,
Nov. 1-3, 1971
- 4-9 Report of the Clinch Valley Study
May 15 - June 2, 1972
ORNL-4835
- 4-10 M.B. Watson et al
Underground nuclear power plant siting
EQL report No 6, Sept. 1972
- 4-11 W.A. Kammer, M.B. Watson
Underground nuclear power plants with surface
turbine generators
Nuclear Engineering and Design 33, 1975
- 4-12 A. Blake et al
A concept for underground siting of nuclear power
reactors
UCRL-51408, May 1973
- 4-13 V.N. Karpenko, C.E. Walter
Underground siting of nuclear power reactors
Proc. Symp. IAEA, Vienna, Dec. 9-13, 1974
IAEA / SM - 188/44
- 4-14 California Power Plant Siting Study
Resources Agency State of California, May 1973
HN-8145.3/4/5

- 4-15 J.A. Milloy et al
Underground siting of nuclear power plants:
potential benefits and penalties
August 1977
NUREG-0255
- 4-16 Sargent & Lundy
Conceptual design and estimated cost of buried
"berm contained" nuclear power plants
January 31, 1978
- 4-17 Underground Design Consultants
Conceptual design and estimated cost of nuclear
power plants in mined caverns (vol. 1,2,3)
- 4-18 The Aerospace Corporation
Evaluation of the feasibility, economic impact, and
effectiveness of underground nuclear power plants
Final technical report
May 1978
- 4-19 S. Pinto
A survey of underground nuclear power plants
Part 4. The main american studies
TM-ST-561, August 1978

CHAPTER 5

THE MAIN EUROPEAN STUDIES

<u>Contents</u>	<u>Page</u>
5.1 Introduction	5-5
5.2 The norwegian Study (1966-69)	5-6
5.3 The CDL Study	5-14
5.4 The NVE Study (1974-75)	5-24
5.5 The BMI-KFA Study	5-30
5.6 The SECURE project	5-40
5.7 Comparison among the studies	5-43
5.8 Concluding remarks	5-46

5.1. INTRODUCTION

5.1.1. As already stated in the preceeding chapter, in the last years, the interest for the underground siting of nuclear power plants has been increasing once more.

Difficulties with the opponents to nuclear power, difficulties with the licensing authorities, difficulties at political level, the possibility of utilizing nuclear power plants for district heating schemes etc. have renewed also in Europe the interest for the underground siting as an alternative to surface siting.

In Europe, the main investigations meant to evaluate the feasibility, the potential safety advantages and the costs of the underground siting have been carried out in Germany, Norway, Switzerland and Sweden.

The underground siting concept investigated in detail in Scandinavia is the rock cavity plant while in Germany the pit siting has been selected as a siting alternative. In Switzerland, both siting options, the rock cavity plant and the pit siting, have been investigated in various studies.

In Germany and Scandinavia great importance has been given to plant protection against acts of war, sabotage and terrorism.

5.1.2. The main studies performed in these last years in Europe on the underground siting will be described in the next paragraphs, with the exception of the swiss studies examined in a separate chapter.

5.2. THE NORWEGIAN STUDY (1966-69)

5.2.1. In the years 1966 - 1969 a study on the underground siting of nuclear power plants has been carried out in Norway by Norsk Hydro AS, the Norwegian Water Resources and Electricity Board (NVE) and the Institutt for Atomenergi (IFA).

For this study, two reactor types have been taken into consideration: a boiling water reactor and an advanced gas-cooled reactor, both rated 500 MW(e) (Ref. 5 - 1).

Underground and surface locations, at specific sites, have been investigated and the construction costs have been compared. The chosen site for the underground plant is a dome shaped rock formation south-west of Oslo, at the sea. Sea water is utilized in both plants for direct cooling.

The aim of this study was to assess the feasibility of the underground siting of nuclear power plants.

The experience accumulated in Norway in the design and construction of underground plants, both hydroelectric power stations and industrial plants, has contributed to the decision to investigate this type of siting as well as building the Halden reactor underground.

5.2.2. The layout of the BWR plant is shown in Fig. 5 - 1 and 5 - 2.

The reactor and the turbogroup are located in a single large cavern, 125 m long, 25 m wide and with a maximum height of 70 m.

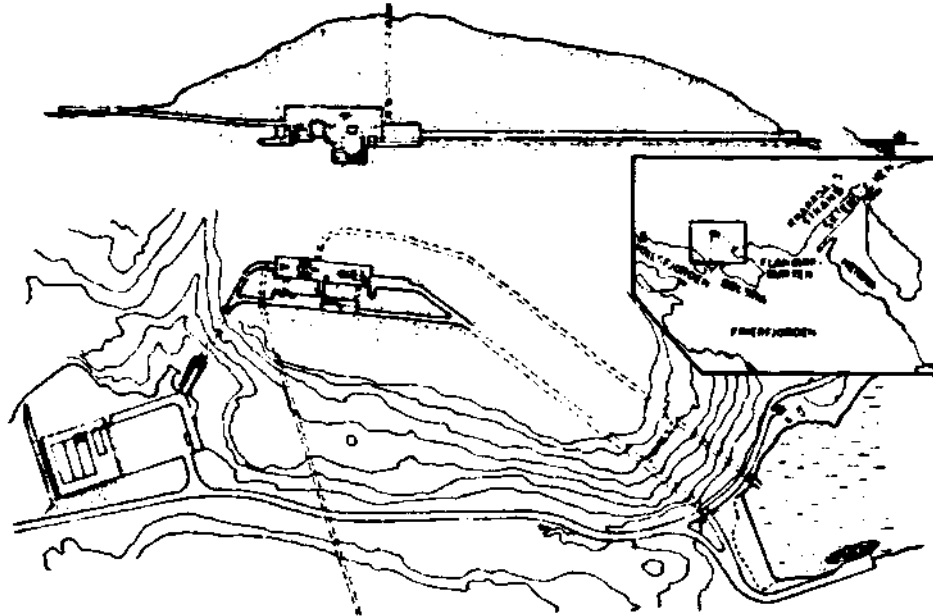

Fig. 5 - 1 Underground BWR: plant layout

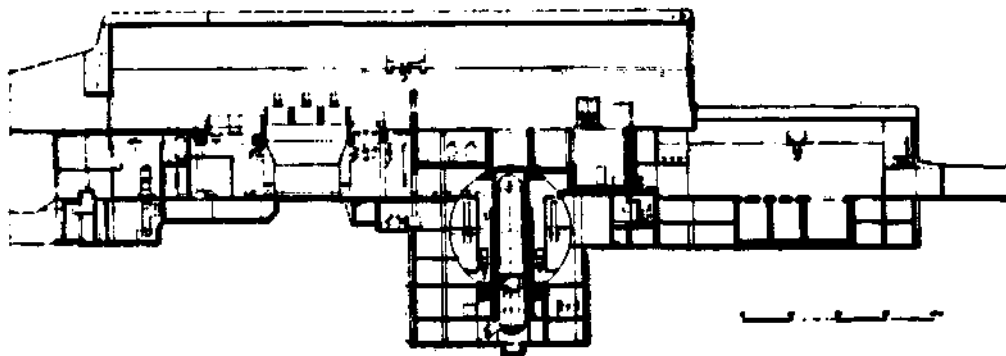

Fig. 5 - 2 Underground BWR: reactor and turbine hall

The reactor and the auxiliary systems are located below the main floor elevation. A concrete wall, about 8 m high, acts as biological shield for the radiation from the turbine hall.

Control room, transformers and electrical auxiliaries are located in another cavern (110 m x 15 m) parallel to the reactor hall, while offices, workshops and the switchyard are located aboveground.

Normal access to the plant is through a long tunnel from the building housing offices and workshops. Fuel and heavy equipment are transported through another tunnel with access near the quay. The length of this tunnel is about 200 m.

The stack for ventilation exhaust is located on the hill housing the plant and is connected through an inclined shaft to the caverns.

The cooling water intake is about 30 m below sea level and the water outlet is by the quay, at sea level.

The total excavation volume has been estimated to be 265,000 m³.

5.2.3. The layout of the AGR plant is represented in Fig. 5 - 3 and 5 - 4.

Also in this plant the reactor and the turbogroup are located in a single cavern, 148 m long, 30 m wide and with a maximum height of 83 m.

To reduce the cavern span, a pod-boiler AGR type has been chosen.

A separate cavern, parallel to the reactor hall, contains the control room, electrical equipment, transformers etc. The dimensions of this cavern are 106 m length, 16 m width and 23 m maximum height.

The main access is through a 225 m long tunnel to the turbine side of the reactor hall. Another tunnel, about 250 m long, runs instead from the quay into the reactor area. Branches in this tunnel accommodate the CO₂ storage plant and the solid waste storage systems.

Offices, auxiliary buildings, workshops, the switchyard etc. are located above ground, adjacent to the entrance of the main access tunnel.

The cooling water intake and outlet are basically the same as those of the BWR plant.

The total excavation volume is about 275,000 m³.

5.2.4. This study has also taken into account the possibility to have multiple units in one site.

The proposed layouts for a twin 500 MW(e) BWR plant and for a twin 500 MW(e) PWR plant are represented in Fig. 5 - 5 and 5 - 6.

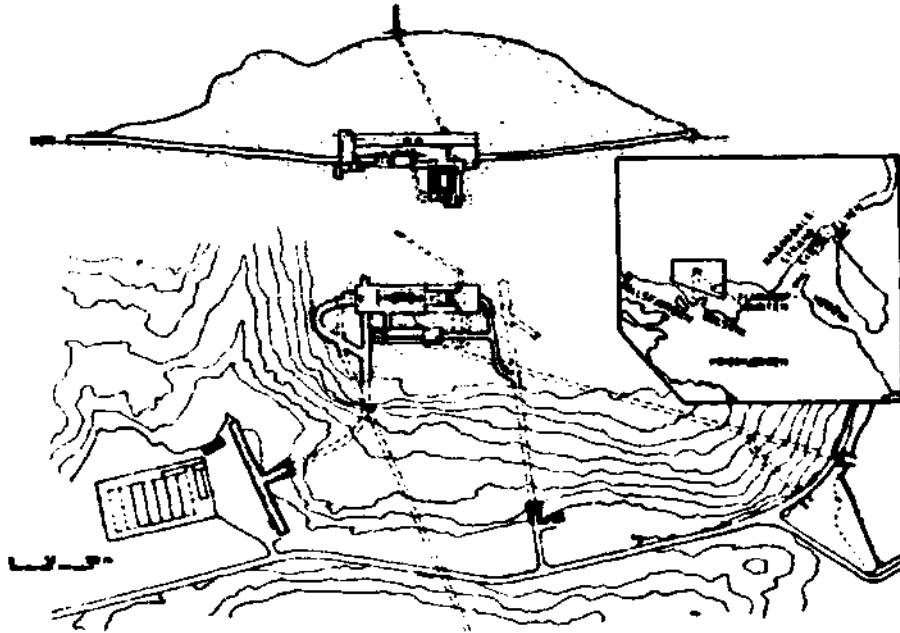

Fig. 5 - 3 Underground AGR: plant layout

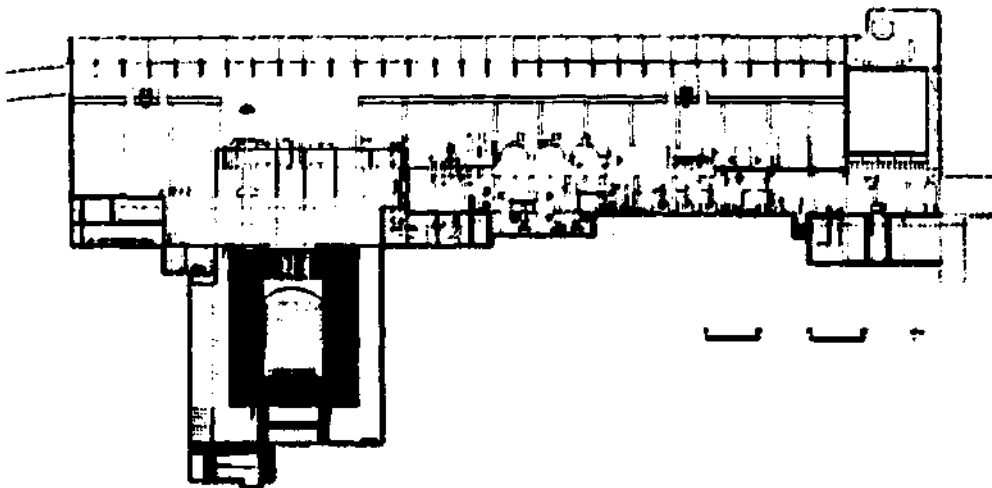

Fig. 5 - 4 Underground AGR: reactor and turbine hall

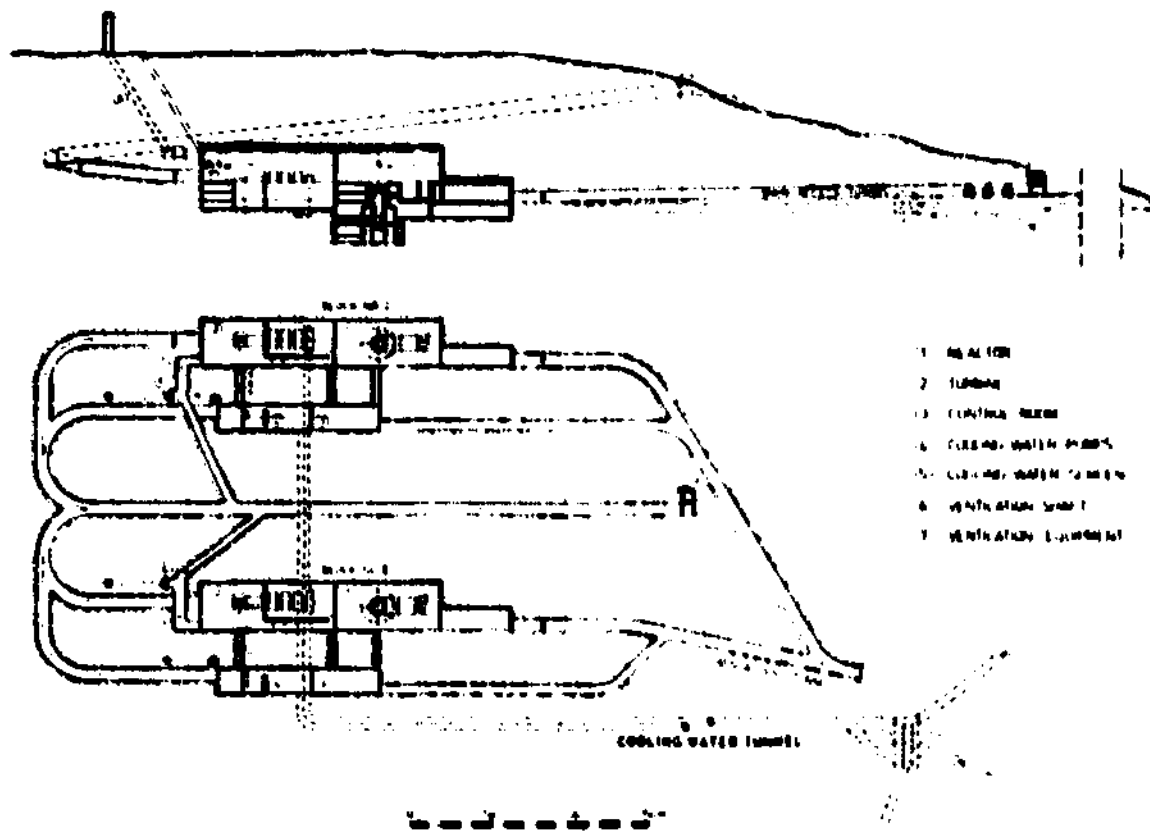

Fig. 5 - 5 Twin 500 MW(e) BWR plant layout

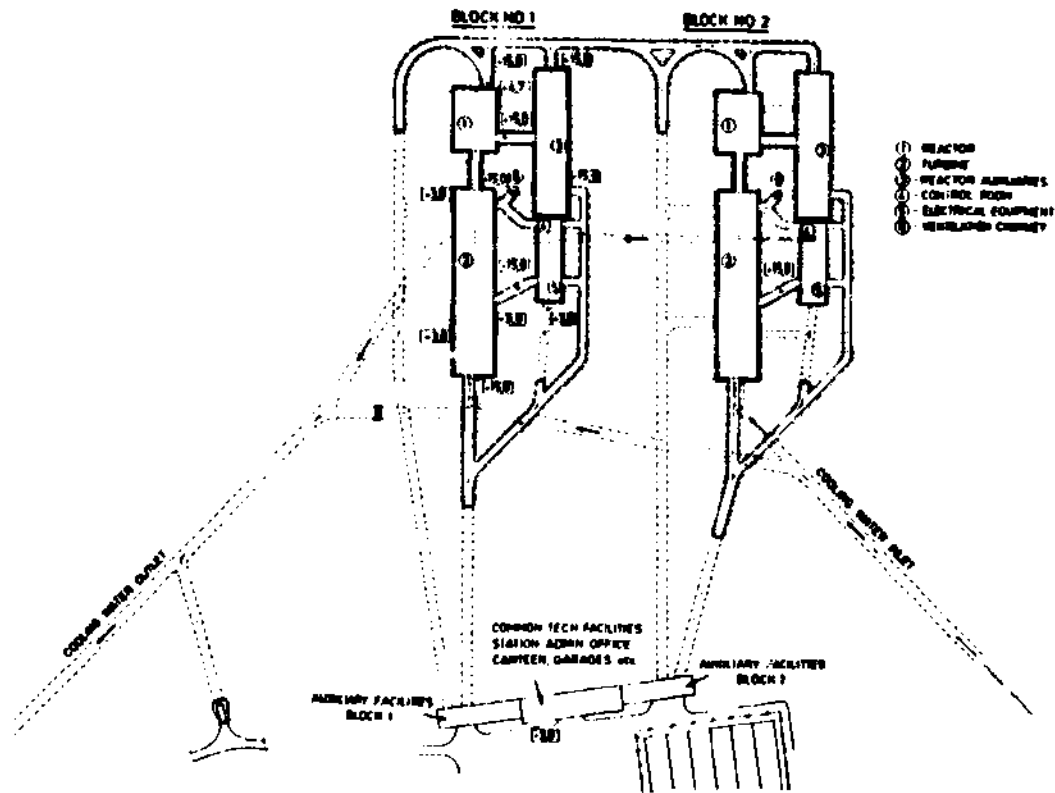

Fig. 5 - 6 Twin 500 MW(e) PWR plant layout

5.2.5. This study has shown that it is technically feasible to site in Norway nuclear power plants in rock cavities.

The location and orientation of the plant caverns have been influenced by various considerations such as rock properties, rock overburden, access and transport during excavation, construction and operation. Also the arrangement of the cooling water galleries has strongly influenced the layouts.

All these requirements have lead to an extensive tunnel system as can be seen from the proposed layouts.

The rock overburden is in the order of 40 - 80 m.

5.2.6. In this study the underground siting has been found advantageous because of:

- improved safety
- possibility of urban siting
- fewer restrictions on the surrounding areas
- reduced effects on the landscape
- better protection against acts of war.

5.2.7. According to this study, the underground siting will increase the construction time by 10 - 12 months and the total construction costs, including interests, by approximately 4 %.

5.3. THE CDL STUDY

- 5.3.1. After the studies performed in the late fifties and the construction of the Agesta plant, the underground siting became again actual in Sweden towards 1973 because of power production and plant protection during war time.

The war protection problem has been investigated by CDL (Centrala Driftledningen), a joint organization of major Swedish power producers in 1974 (Ref. 5 - 2), for a BWR rated 900 MWe, taking as reference the Forsmark plant. Different alternatives of siting a nuclear power plant - with the smallest possible departures from the reference plant - in open cut excavations and in rock have been investigated.

According to the conclusions of this study, rock siting ensures a better war protection than the pit siting, costs and construction time being approximately the same. Furthermore, the impact of a rock cavity plant on the landscape is considered lower than for the pit siting. Therefore, the study has been continued on the rock cavity alternative.

In a report published in 1975 (Ref. 5 - 3), advantages and disadvantages from the safety standpoint of a rock cavity plant have been investigated in comparison with an equivalent surface plant.

A third phase of the study (Ref. 5 - 4) has further examined some problems as safety, operation, maintenance, sabotage, war protection, costs and decommissioning.

5.3.2. The aim of the CDL study was to identify and clarify the advantages and disadvantages, from the safety point of view, of a nuclear power plant located in rock cavities for war protection reasons.

The following design criteria were established:

- the plant should be designed to ensure protection against external acts of war with conventional weapons (ten ton mine-bombs)
- the plant should have at least the same safety level of a surface plant
- the design of the plant should take advantage of the inherent properties of a rock location to improve safety.

5.3.3. Based on these criteria, four alternative plant configurations have been investigated.

These configurations are (Fig. 5 - 7):

1. a reactor with complete containment located together with the main auxiliary equipment in a sealed cavern,
2. a reactor with complete containment located together with auxiliary equipment in a cavern open to the atmosphere,
3. a reactor located together with the main auxiliary equipment in a closed cavern constituting the containment,
4. a reactor located in a containment directly surrounded by the rock. The auxiliary equipment is located in a separate cavern.

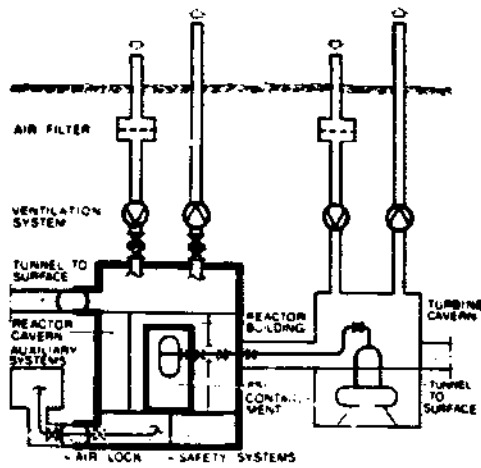

ALTERNATIVE 1 REACTOR WITH COMPLETE CONTAINMENT PLACED TOGETHER WITH CENTRAL AUXILIARY EQUIPMENT IN A CLOSED CAVERN

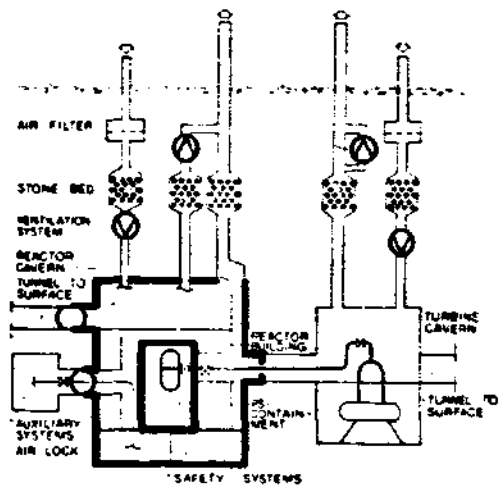

ALTERNATIVE 2 REACTOR WITH COMPLETE CONTAINMENT PLACED TOGETHER WITH AUXILIARY EQUIPMENT IN A CAVERN OPEN TO THE ATMOSPHERE

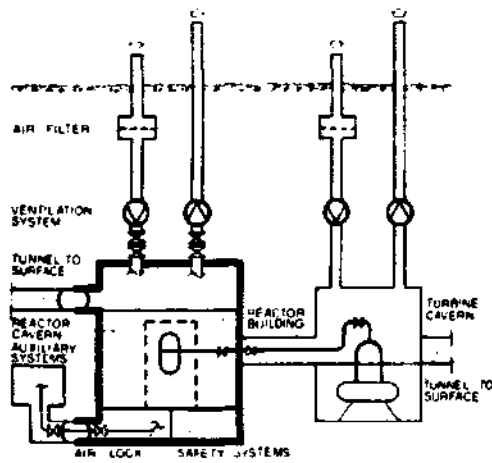

ALTERNATIVE 3 REACTOR PLACED TOGETHER WITH CENTRAL AUXILIARY EQUIPMENT IN A CLOSED CAVERN CONSTITUTING THE CONTAINMENT

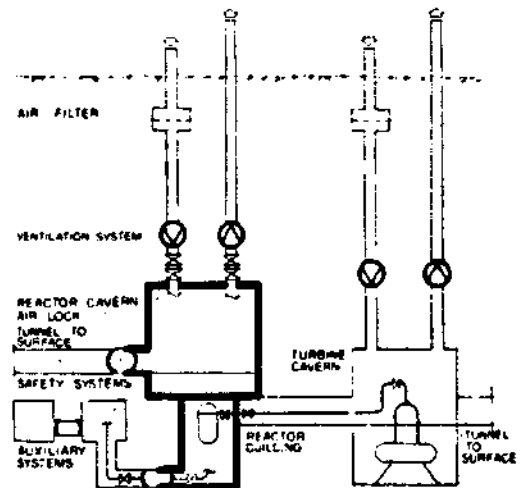

ALTERNATIVE 4 REACTOR PLACED IN A CONTAINMENT DIRECTLY SURROUNDED BY THE ROCK AUXILIARY EQUIPMENT PLACED IN SEPARATE CAVERNS

Fig. 5 - 7 Alternative designs of a rock cavity plant

In alternative 1 the reactor is located in a conventional pressure suppression containment surrounded by a reactor building in a cavern located about 50 m below the surface. The reactor cavern is made as tight as possible and strong enough to withstand any load from missiles, pressure and temperature that could occur in extreme and improbable accidents.

Connecting tunnels are equipped with locks and penetrations that can withstand the same loads as the reactor cavern. Ventilation shafts are equipped with fast closing isolation valves as all piping that penetrates the cavern. Some safety systems are located in protected spaces near the bottom of the reactor cavern or in other separate caverns.

Alternative 2 differs from alternative 1 in that the reactor cavern communicates directly with the atmosphere through ventilation and steam relief channels filled with stone beds connected with stacks on the surface. The requirements for rock quality are lower than for alternative 1 since the cavern should not withstand high pressures for long time.

Alternative 3 is similar to alternative 1 without the pressure suppression system. Infact, in this alternative, total reliance is placed on the cavern for containment. In that way a full pressure containment is realized.

In alternative 4 the pressure suppression containment is in direct contact with the rock. The hall above the reactor building is part of the reactor cavern and will be pressurized following a containment failure. Ventilation channels are equipped with isolation valves and the connecting tunnels with locks. All safety systems are located in separate caverns.

- 5.3.4. Alternative 2 has been chosen and further investigated giving importance to the criterion "same safety level as above ground".

As a consequence of the desire to use proven technology in the underground siting the reactor cavern is open to the atmosphere. Infact, if the cavern is sealed, certain pipe rupture accidents may give origin to overpressures that could be difficult to cope without important design alterations.

The chosen alternative, rather than the others, is more close to the design of above ground plants. Accident scenarios that lead to small or moderate radioactive releases above ground will be the same underground. The loads on the cavern, caused by major accidents, will be rapidly minimized since the pressure is relieved to the atmosphere. Moreover, the releases, if any, will be at high level through the stack and filtered by the stone beds.

A reduction of the release by a factor of 10 is considered realistic.

- 5.3.5. The plant layout is represented in Fig. 5 - 8 to 5 - 11.

The whole plant is underground: reactor, turbine, auxiliary systems, switchyard etc. are all located in caverns. The underground layout has been developed basing on an Asea-Atom BWR 3000 plant. The reactor and auxiliary systems are located in three caverns while the turbine and related equipment and systems are located in four caverns.

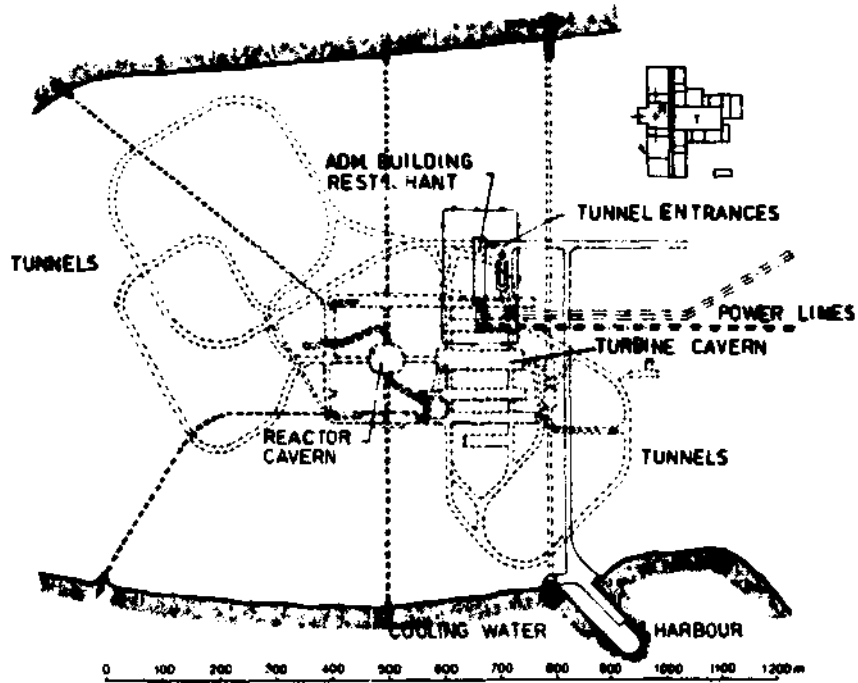

Fig. 5 - 8 CDL study: plant layout

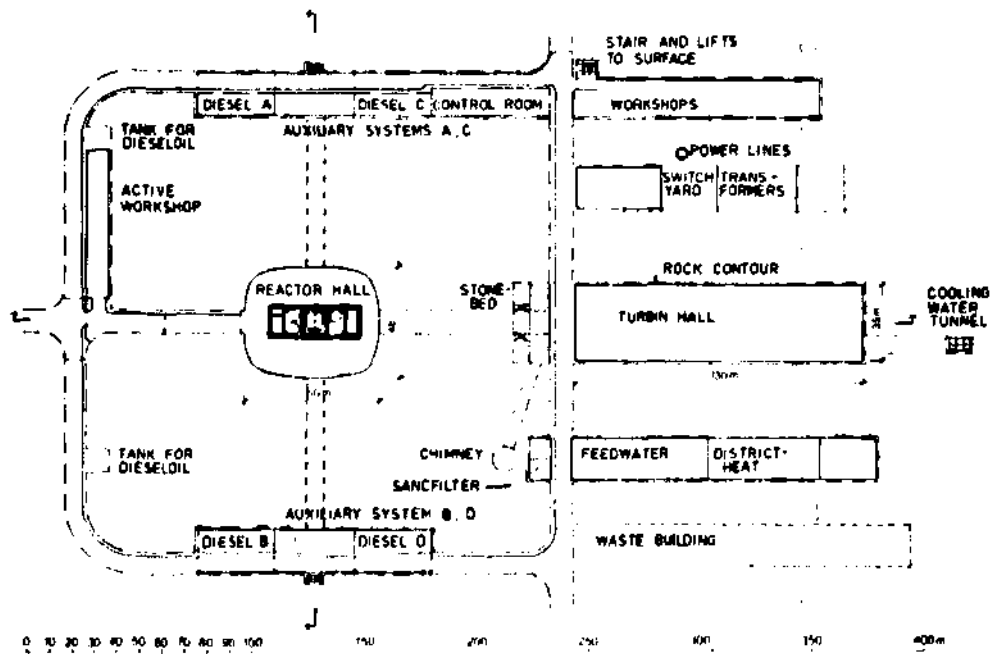

Fig. 5 - 9 CDL study: plant view at reactor hall elevation

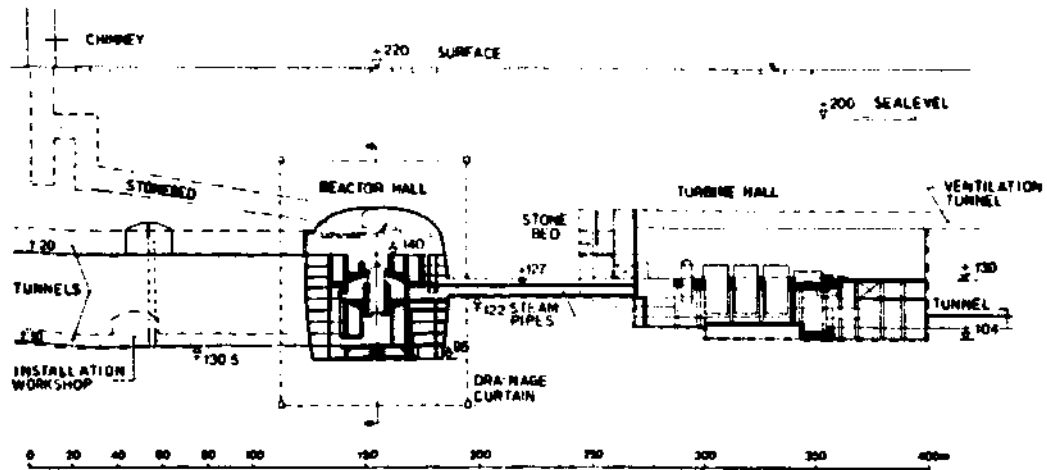

Fig. 5 - 10 CDL study: cross section reactor-turbine hall

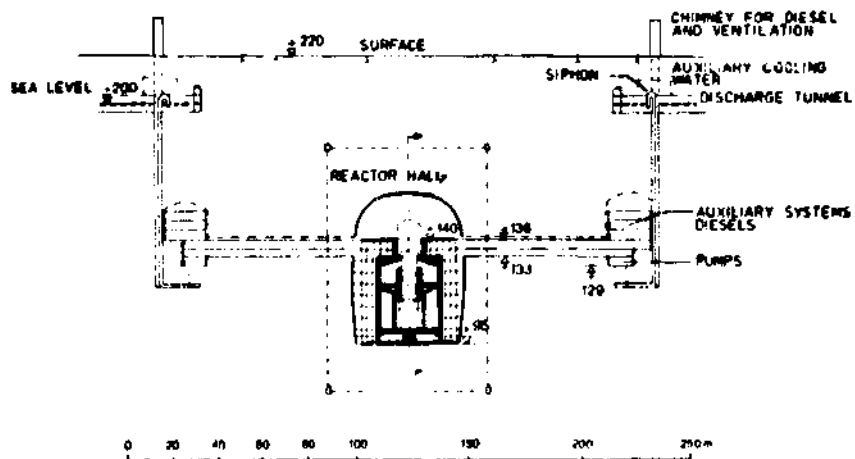

Fig. 5 - 11 CDL study: cross section reactor-auxiliary systems

These caverns are orientated in the same direction because of rock mechanics reasons. The rock overburden is about 60 m.

The plant is located below sea level and is cooled by sea water. A location above sea level could have probably been more advantageous in some respects but would have limited the choice of possible sites.

5.3.6. The reactor is located in a building in a cavern lined with concrete about 1 m thick to ensure the integrity of the cavity when exposed to loads from missiles or extreme accidents. The dimensions of the reactor cavern are 60 m length, 48 m width and about 65 m height.

This cavern communicates with the atmosphere through ventilation and pressure relief channels connected with 100 m high stacks. Stone beds are located in these channels - dimensioned to avoid unacceptable pressure rises in the reactor cavern - to condense steam and filter particulate contaminants.

To avoid ground water pressure on the concrete lining, the rock is drained with a system of holes drilled about 10 m behind the cavern walls.

Redundant systems as auxiliary cooling and spray systems, diesels etc. are located in two separate caverns at the opposite sides of the reactor cavern to achieve a good space separation.

The control room is located in one of these caverns.

Steam and feedwater pipes run through the tunnel connecting the reactor cavern to the turbine hall. As in above

ground plants, this tunnel has isolation valves at the containment. A penetration seal in this tunnel eliminates the risk of radioactivity leaking into the turbine cavern in case of a major accident.

In case of a pipe rupture inside the penetration seal, the steam will be vented to the atmosphere through a separate pressure relief channel equipped with a stone bed. In the case of a pipe rupture outside the penetration seal, the steam will be instead vented through the turbine hall's pressure relief system, also equipped with stone beds.

The turbine, located in a cavern 130 m long, 35 m wide and about 47 m high, is of the backpressure type for district heating purposes. On both sides of the turbine cavern there are various other caverns for feed water and preheaters, district heating equipment, the switchyard, workshops, active waste treatment facilities etc.

5.3.7. Since the plant, as previously mentioned, is located below sea level, flood protection is quite important.

The cooling system of the turbine condenser and the separate system for auxiliary cooling, for instance, are connected to cooling water channels by siphons. In case of a large rupture in a cooling system, the siphon is automatically interrupted because of the fall of the water level in the channel. In case of small leaks the siphon can be broken by air inlet through valves actuated by level control devices in the caverns.

Besides this shutoff system, some caverns are also designed to hold substantial amounts of water without jeopardizing

plant safety.

Even if the plant safety systems are the same as for an above ground plant, in the reactor cavern there is, for long time cooling after a major accident, a water spray system.

- 5.3.8. According to the study, a rock cavity plant has a significant safety potential especially for what concerns hypothetical major accidents. The same advantages, however, cannot be expected in case of accidents as those normally considered in designing nuclear power plants.

Rock siting is considered advantageous also for what concerns protection against acts of war and other external events and, to some extent, for the plant decommissioning. Infact the costs of decommissioning are considered to be about 50 % lower than for a surface plant.

- 5.3.9. The construction time for the plant has been estimated to be about 1 1/2 years longer than for an equivalent above ground plant and the cost increase, with a 10 % interest rate, about 15 - 20 %.

These costs include design and exploration, excavation, reinforcement work, groundwater control, erection in confined space, additional equipment and additional administrative and financial charges.

5.4. THE NVE STUDY

5.4.1. The Norwegian Water Resources and Electricity Board (NVE) has carried out in 1974 - 1975 a study on the underground siting following a parliamentary request stating that consideration should be given to the possibility of building the first nuclear power plant in Norway totally or partially in rock cavities to ensure power production during wartime (Ref. 5 - 5).

Main objectives of the study have been to develop a detailed layout of a rock cavity plant and to investigate the safety characteristics of the siting, the necessary construction techniques, the operating and maintenance aspects, the costs and the construction schedule and procedures.

A specific site (Haraldsfjell, near Oslo) has been chosen to allow a realistic comparison with a surface plant.

The study is based on a 1000 MWe KWU-PWR, cooled by seawater.

5.4.2. The main assumptions made for the study are the following:

- the plant should be protected against acts of war to ensure power production during war time
- the plant should satisfy the same safety standards of above ground plants (in this case the west-german safety regulations)
- in order to avoid introducing unnecessary uncertainties standardized systems and layouts should be used.

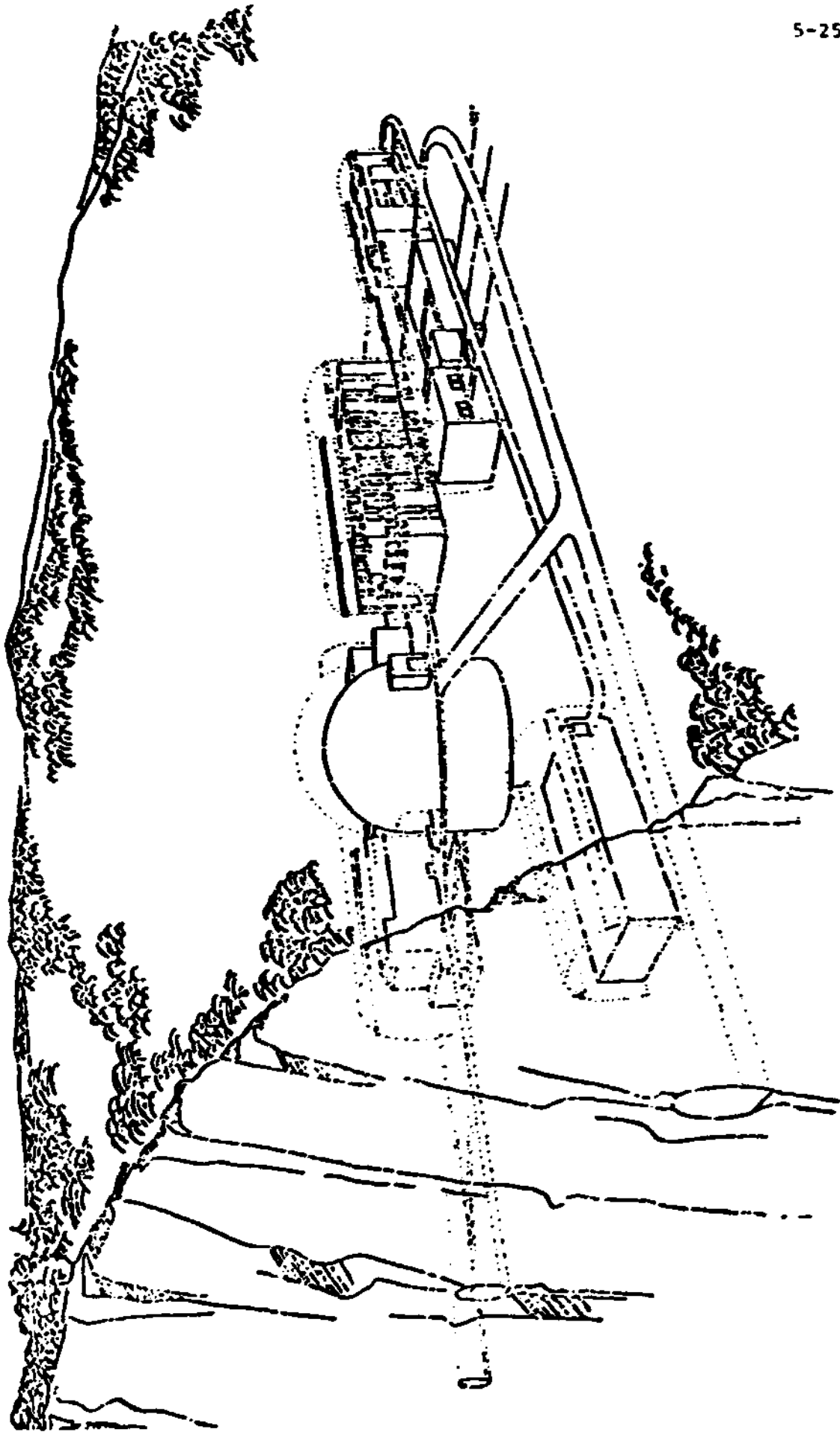

Fig. 5 - 12 Outline drawing of the MVE plant

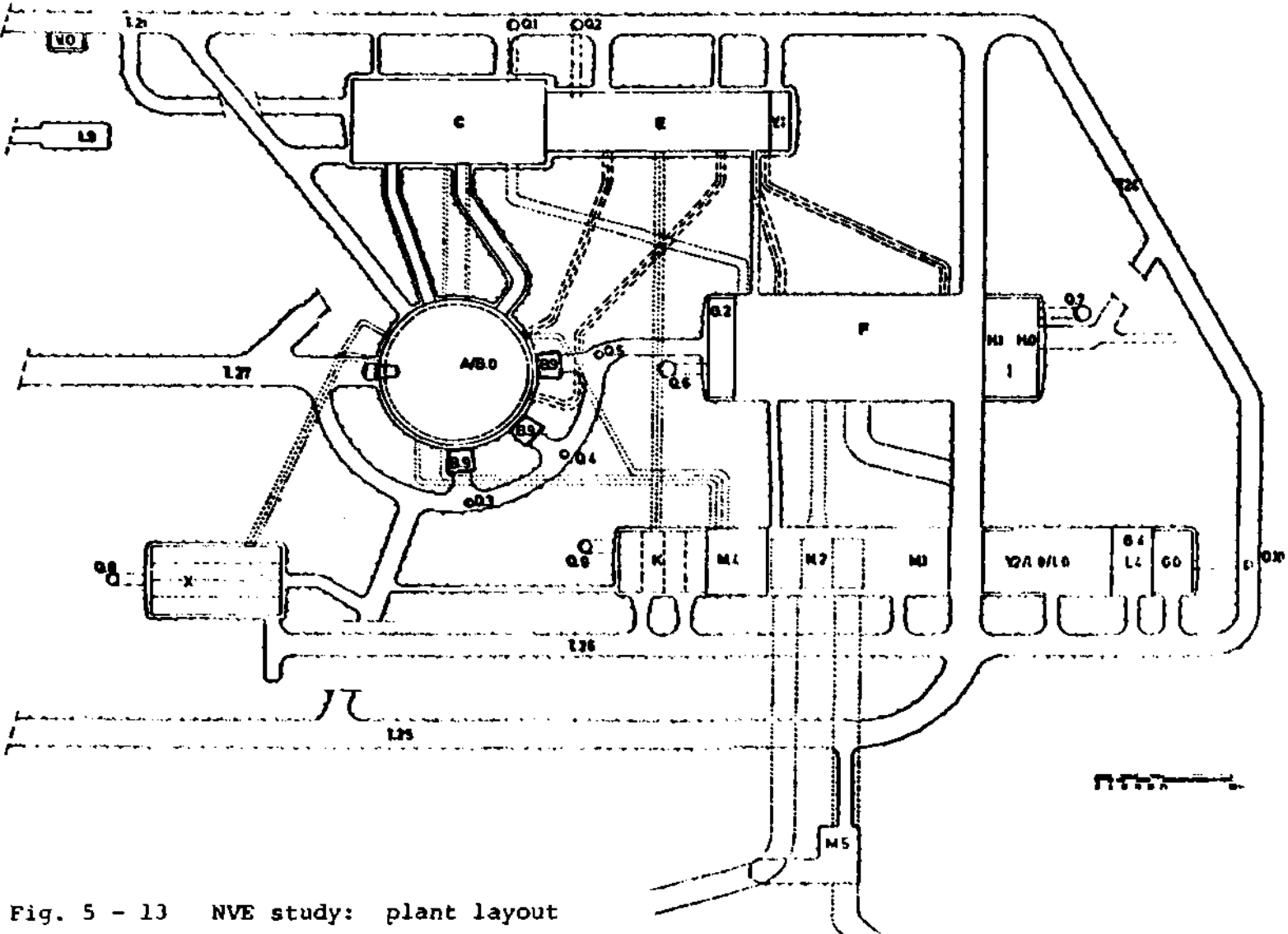

Fig. 5 - 13 NVE study: plant layout

5.4.3. The plant layout is shown in Fig. 5 - 13.

Plant buildings and components are located in four large cavities, connected by tunnels.

The reactor building is housed in a cavern, cylindrical in shape with a hemispherical roof, with a diameter of about 60 m and a height of about 65 m. Systems, components and layout of the reactor building are the same as in the reference plant and also the same containment system, with a double containment, has been maintained.

The reactor building is freestanding in the cavern.

The turbine cavern is 125 m long, about 40 m wide and 39 m high.

The cavern houses the turbine, the generator and all auxiliary equipment necessary for the turbogroup. Plant transformers and a high-voltage switchgear are located in a section of the cavern.

Reactor auxiliary systems and electrical building are located in a cavern about 160 m long. The auxiliary building includes a workshop for active components and a storage space for radioactive wastes, sufficient for five years plant operation.

The electrical building is divided in four sections corresponding to the four safety trains. The control room is located in this building.

The fourth large plant cavern contains the auxiliary equipment for the power plant. The emergency diesels, the reactor auxiliary cooling water pumps, the turbine cooling water pumps, make-up water treatment equipment, workshops etc.

are in this cavern about 210 m long.

A separate cavern houses the emergency feed water systems. The complete control equipment for these systems, as well as an auxiliary control room are located in the same cavern.

Access to the plant is through three main tunnels. Ten ventilation shafts connect the underground structures with the surface.

5.4.4. A safety evaluation has been made identifying some of the main differences between a rock cavity plant and a surface plant.

The main conclusions of this evaluation are the following:

- there is no significant difference between an underground and a surface plant for what concerns the probability and the consequence of a DBA
- rock fall is a new accident initiating event peculiar to a rock cavity plant
- the radiological consequences of a core meltdown do not differ significantly from those of a surface plant
- a rock cavity plant is better protected against acts of war and aircraft crashes.

5.4.5. The study concludes that there is no technical constraint which could prevent the construction of an underground nuclear power plant in Norway.

Data available on existing rock cavities, both natural and man-made, indicate that cavities with dimensions as those required for undergrounding the plant are feasible.

A rock cavity plant may be considered advantageous also for what concerns decommissioning due to the fact that the plant must not be dismantled because of landscape considerations.

Compared with a surface plant the construction time is increased by 24 months. This increase is mainly due to caverns excavation and reinforcing work.

The erection of plant components in the cavities is considered to require about 6 months more than for a surface plant. Plant operation and maintenance have been found to be slightly more expensive than above ground.

The cost of a rock cavity plant has been estimated, taking into account a 10 % interest rate, to be about 24 % higher due mainly to rock blasting and associated work. Higher difficulties in construction and erection have also contributed to increase the costs.

5.5. THE BMI-KFA STUDY

5.5.1. In 1974 the German Ministry of the Interior (BMI) requested KFA Jülich to perform a study of the "cut and cover" design of a large, modern nuclear power plant.

The aim of the study was to assess the technical feasibility, the costs and the safety potential of such a siting concept.

Basing on a 1300 MWe KWU-PWR, similar to the Grohnde plant, detailed layouts have been developed and actual site conditions have been taken into account to perform a realistic comparison with above ground conditions. A distinction has been made between reactor building total embedment and semi embedment as a possible range of variation for the plant depth of burial.

The possibility of a surface mounded plant or to cover with soil already existing surface plants has also been briefly examined.

5.5.2. The main requirements for the underground plant have been fixed as follows:

- the safety standards of the underground plant should be at least the same of the reference design and, basing on actual regulations, the plant should be licensable
- the plant should ensure a better protection against major hypothetical accidents

- the plant should be better protected against external events, including sabotage and terrorism.
- the plant should be better protected against acts of war
- the plant should be protected in such a way as to ensure power production also during war time or crisis time.

To maintain plant licensability, major redesign of the reference plant has been avoided. The layout of the most important buildings, equipment and systems has been kept in principle as in the reference plant maintaining then the above ground safety standards.

5.5.3. Possible layouts of a totally embedded and semi embedded plant are represented in Fig. 5 - 14 to 5 - 19.

The layout of the totally embedded plant (Fig. 5 - 14) is slightly more compact than that of the reference plant. Reactor building, auxiliary and electrical buildings, emergency feed systems building and some tunnels are located below grade, at different elevations, and covered with backfill.

The reactor building is surrounded by an annular space, 3 m wide at the lower level and about 6 m at the upper level, divided in sectors by vertical walls, accomodating mainly connecting lines to other systems.

The turbine house (rotated of 90° with respect to the reference design), the emergency diesels building, the pumphouse and the cooling towers are located above ground.

To increase protection against the worst internal accidents, an additional containment is provided, consisting of the outer walls of the annular space that surrounds the containment and the soil and backfill together with the closures of the existing connections to the surface. This additional barrier against radioactive leakages can be designed to withstand any potential accident.

Access tunnels, dimensioned for the transport of large and heavy components, are all located about 2 m above grade to ensure protection against flooding. These tunnels, built with a slight positive slope towards the underground facility, are equipped with airlocks. The interlocked doors are blast-resistant doors designed to withstand the maximum foreseen loads both from the inside and the outside.

- 5.5.4. The layout of the semiembedded plant (Fig. 5 - 17) is quite similar to that of the totally embedded plant.

The main difference concerns the reactor building depth of burial (24.7 m instead of 51 m). Other minor differences concern instead the location of the steam and feed pipes between containment and turbine, the layout of the upper level of the annular space etc.

- 5.5.5. According to the study, plant protection against conventional weapons can be achieved by increasing the thickness of the backfill from about 8 m to 11 m and superimposing a concrete shield plate about 2.2 m thick (Fig. 5 - 20).

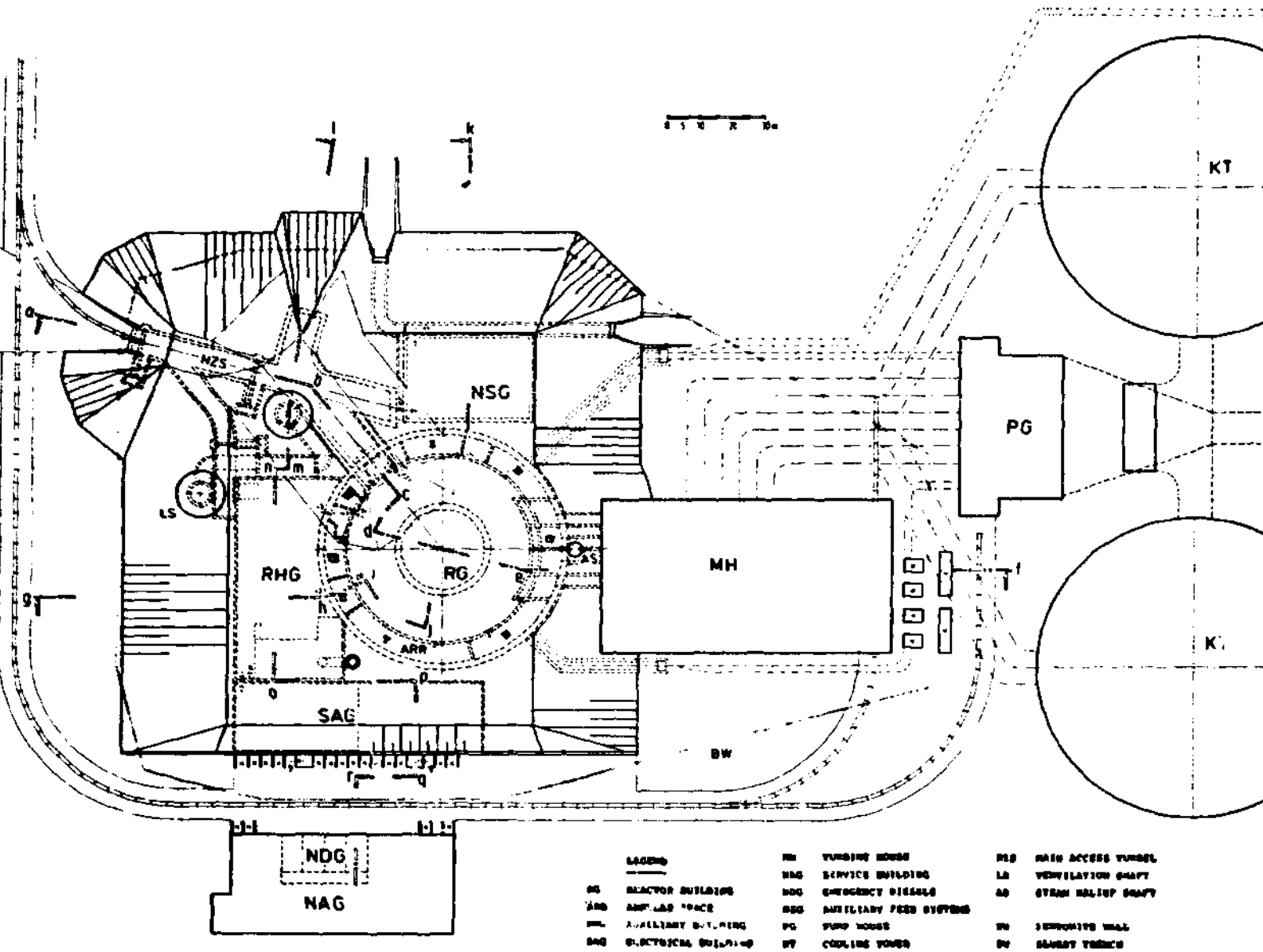
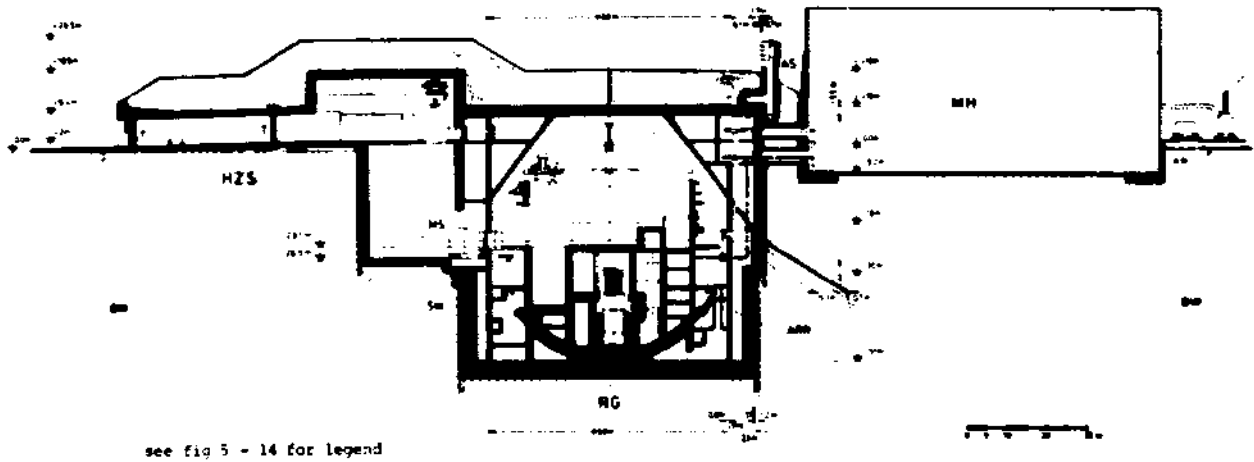
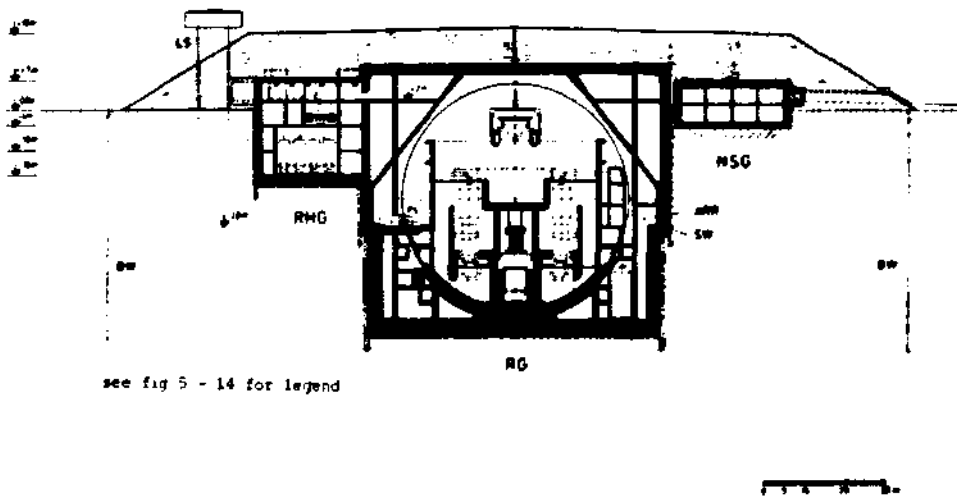

Fig. 5 - 14 BMI-KFA study: totally embedded plant 1



see fig 5 - 14 for legend

Fig. 5 - 15 BMI-KFA study: totally embedded plant layout cross section a-f



see fig 5 - 14 for legend

Fig. 5 - 16 BMI-KFA study: totally embedded plant layout cross section g-k

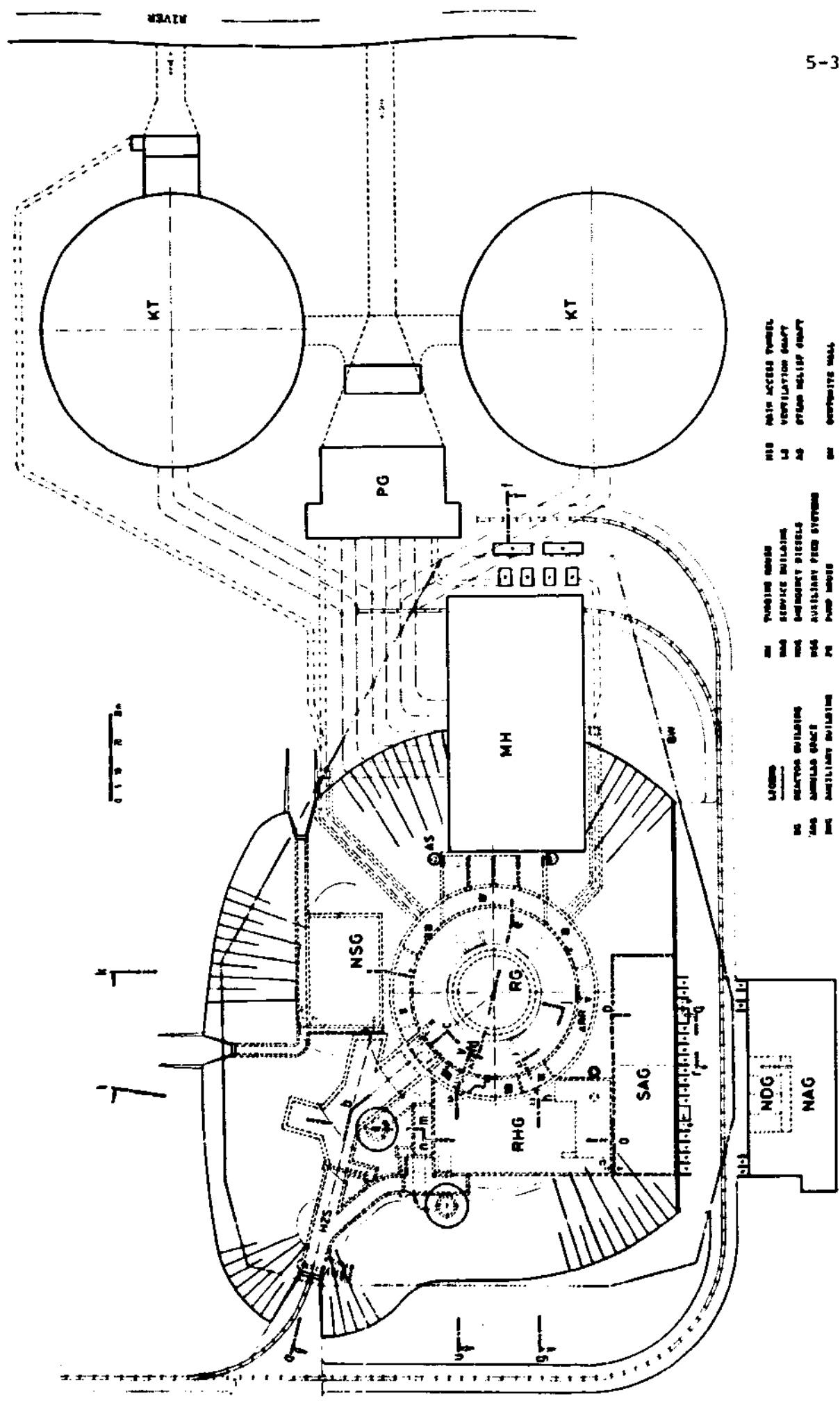
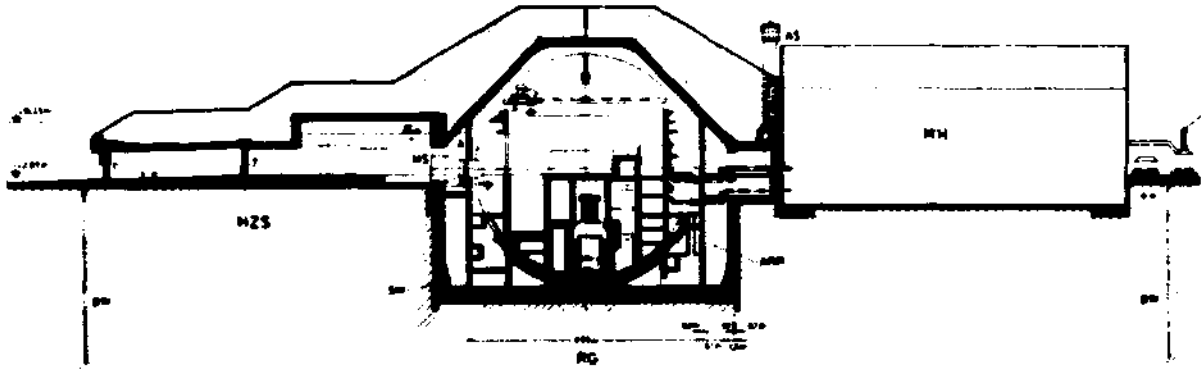
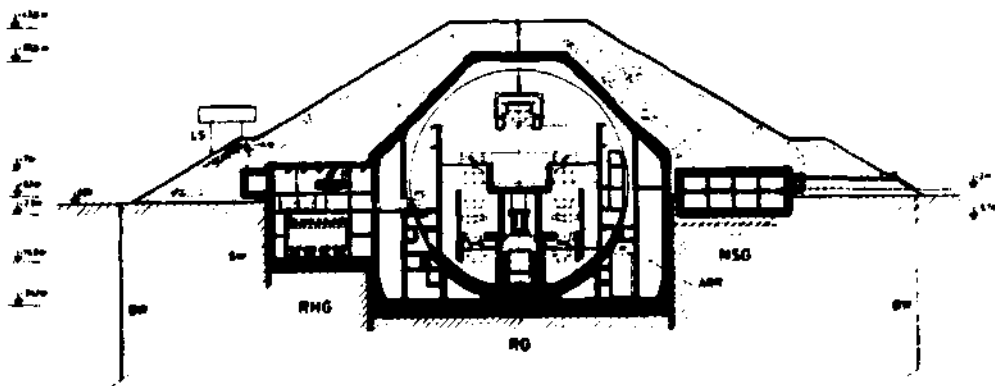

Fig. 5 - 17 BMI-KFA study: semi-embedded plant layout



see fig 5 - 17 for legend

Fig. 5 - 18 BMI-KFA study: semiembedded plant layout cross section a-f



see fig 5 - 17 for legend

Fig. 5 - 19 BMI-KFA study: semiembedded plant layout cross section g-k

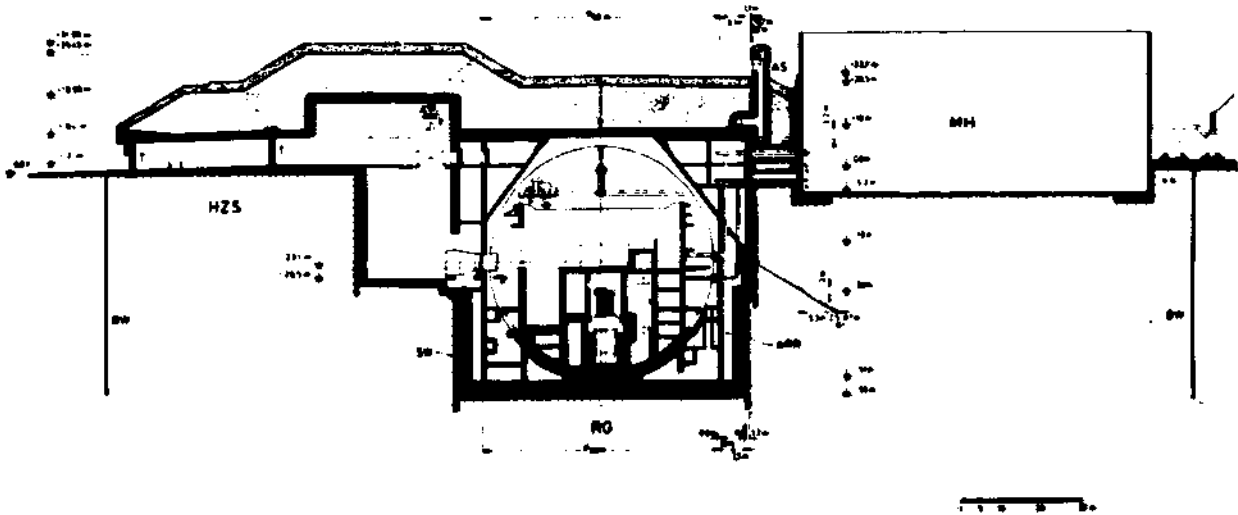

Fig. 5 - 20 BMI-KFA study: cross section of a totally embedded plant with protection against conventional weapons

To secure the energy supply during war time it is necessary to cover with backfill all those plant buildings and components which are vital for a continued plant operation but cannot be repaired in a short time after being damaged or destroyed.

Turbine building, transformers stations, pumphouse and cooling water lines are among these structures.

5.5.6. For embedding the plant, a pit with a diameter of 70 m and a depth varying, because of economical considerations, between 30 and 60 m should be excavated.

The technical feasibility of constructing open pits with

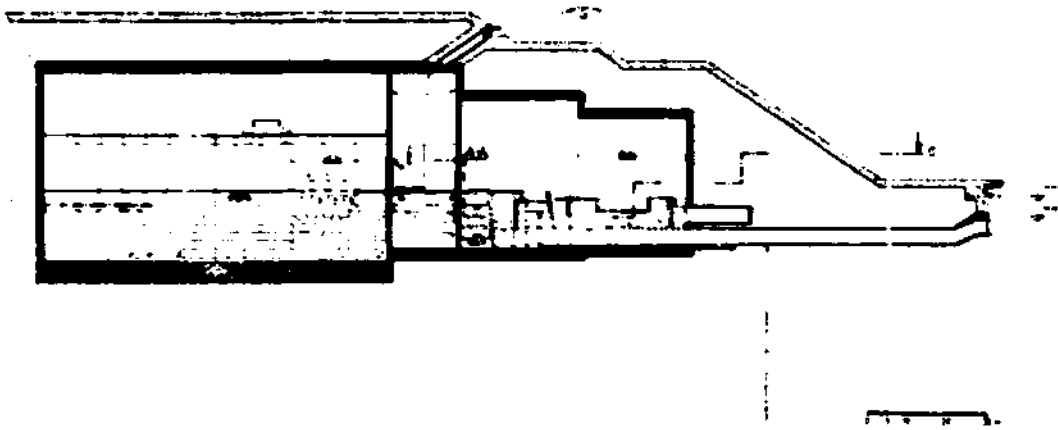

Fig. 5 - 21 BMI-KFA study: cross section of totally buried plant (turbine hall and pumphouse)

such dimensions has already been proven in Germany even in the case of a high groundwater table.

Slurry trenches and freezing techniques may be used for the vertical walls of the excavation.

5.5.7. The main conclusions of the study are the following:

- the examined concepts appear to be technically feasible: possible technical difficulties however should not be underestimated
- the underground plant shows a higher safety potential than a surface facility against major hypothetical accidents and external events. This safety potential is however strongly dependent on the closures

- the depth of burial is not strongly affecting the potential gain in safety since a well designed backfill cover can act as natural soil
- the semiembedded plant appears to be the more economical alternative
- lower decommissioning costs may be assumed.

According to the protection degree, the costs for a totally embedded plant will be about 11 to 14 % higher than a corresponding surface plant and for a semiembedded plant 8 to 10 %.

These additional costs are mainly due to the pit excavation (2 to 4 %), backfill (1 %), additional expences for tunnels (3 %) and costs of buildings construction (1.5 %).

The construction period will be extended by about 1.4 years, mainly because of the pit construction.

5.6. THE SECURE PROJECT

5.6.1. The SECURE reactor (Safe Environmentally Clean Urban Reactor) was developed by a joint Finnish-Swedish project group in 1976 - 1977.

SECURE is a small, low temperature (115 °C) and low pressure (75 bars) nuclear reactor designed for district heating purposes in an urban site, with a rating of 200 MW_{th}.

The special safety requirements for such a plant have lead to an unconventional design with certain inherent safety features to guarantee a safe shut-down without the use of any active components (Ref. 5 - 7, 5 - 8). The role foreseen for such a reactor is to provide the baseload heating of large and medium size urban centres. The rating of 200 MW_{th} is considered sufficient for a town of about 100 000 inhabitants.

Considerations about the effects of war and sabotage have led to the underground siting of the plant.

Environmental considerations have also played a big role in the choice of this type of siting.

5.6.2. The plant layout is represented in Fig. 5 - 22.

The reactor, the primary cooling circuit and the reactor auxiliary systems are located in an underground rock cavern.

The secondary heat exchangers, connected to the district heating net, are located in a building above ground.

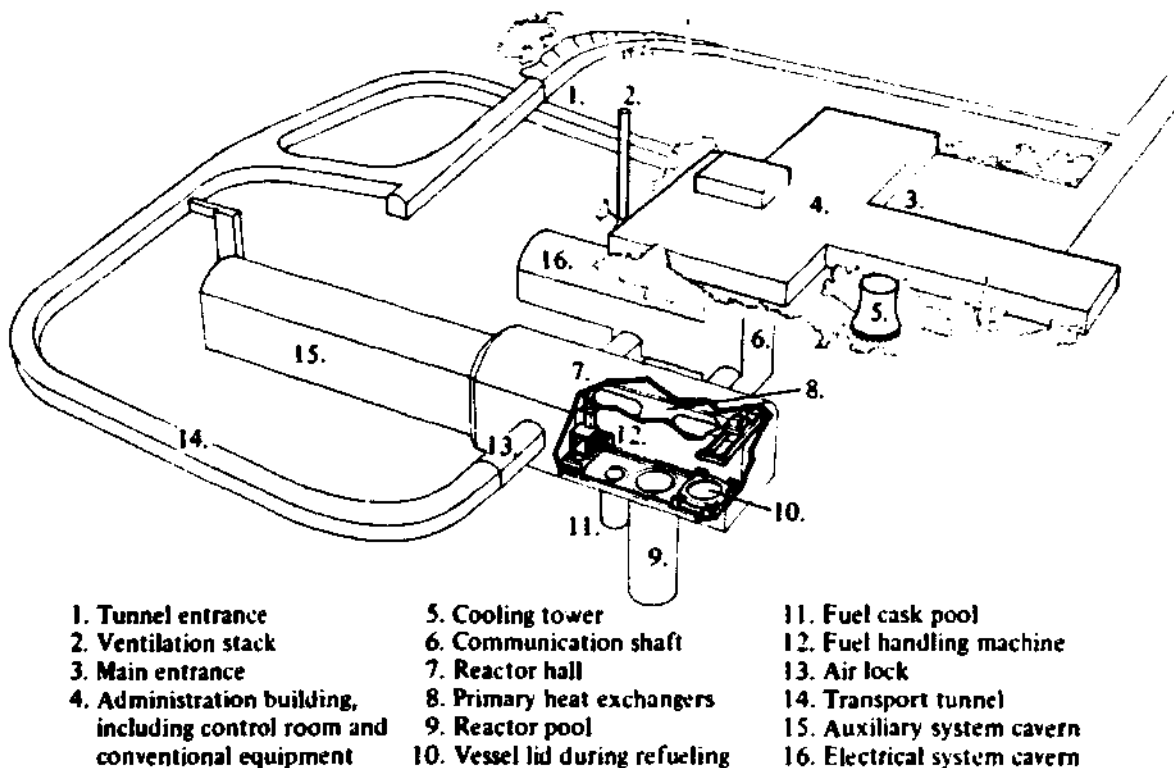

Fig. 5 - 22 SECURE plant layout

This building contains also plant auxiliary systems such as ventilation systems, heating systems, main transformers and distribution systems.

A control room, to operate remotely the reactor, is located above ground. This control room, completely automatic, is unmanned.

No safety related equipment is located above ground.

A small cooling tower dissipates to the atmosphere the reactor residual heat.

5.6.3. In general, a concrete building should be provided as underground reactor containment.

In the case of good rock quality (as that in Scandinavia) a blasted chamber with the walls injected with concrete is considered to be sufficiently leak-tight to serve as reactor containment without any other sealing arrangements.

In case of an accident, automatic valves close automatically the reactor hall ventilation system in order to isolate the reactor cavern and to confine underground any radioactive leakage.

The pressure buildup following an accident is very low due to the low pressure and temperature in the system and to the large volume of the underground reactor chamber.

The rock acts as an effective heat sink for the steam and can reduce the pressure in the reactor cavern to normal values within a few minutes.

No containment spray system is required.

5.6.4. More details on the layout as well as cost estimates are not available at the moment.

5.7. COMPARISON AMONG THE STUDIES

5.7.1. The studies described in this chapter have investigated in detail the rock cavern siting and the cut and cover alternative.

The surface mounded option as well as the possibility to cover with backfill aboveground plants have been briefly mentioned in the study performed on behalf of the German Ministry of the Interior (Ref. 5 - 6).

Main aim of these studies was to assess the technical feasibility, the safety potential and the costs of the chosen underground siting concepts.

5.7.2. With the exception of the SECURE reactor (200 MW_{th}) all these studies are based on LWR rated 1000 - 1300 MWe.

The studies performed in Scandinavia have dealt with the rock cavity alternative, for plants totally located underground.

Protection against acts of war and sabotage was the main motivation for these investigations.

This motivation, together with the possibility of urban siting, has been also the main reason for designing the SECURE plant in rock cavities.

The study performed in Germany has dealt with the pit siting concept.

Two possible alternatives have been investigated: a totally

embedded plant and a semiembedded plant. Also in this study great importance has been given to the protection against acts of war and sabotage.

5.7.3. According to these studies, the main advantages of the underground siting are

- improved safety in case of major hypothetical accidents
- better protection against acts of war
- possibility of urban siting
- less problems for plant decommissioning

Main disadvantages are instead

- the longer construction time
- the higher construction costs

STUDY	YEAR	REACTOR TYPE & RATING	PLANT CONFIGURATION	CONTAINMENT TYPE & DIMENSIONS (l x v x h) m	COST INCREASE VS A SURFACE PLANT	INCREASED CONSTRUCTION TIME (months)
Norsk Hydro NVE IFA (N)	1966- 1969	BWR 500 MWe	hillside plant in two principal underground galleries	rectangular cavern 125 x 25 x 70	4 %	10 - 12
		AGR (pod boiler type) 500 MWe	hillside plant in two principal underground galleries	rectangular cavern 148 x 30 x 83		
CDL (S)	1975	BWR 1000 MWe (Asea Atom BWR 3000)	deep below the surface plant in various caverns under the recipient level	rectangular cavern 60 x 48 x 65	15 - 20 %	18
NVE (N)	1974- 1975	PWR 1000 MWe (KWU)	hillside plant in various caverns	cylindrical cavern with a hemispherical roof $\phi = 60$ m $h = 65$ m	24 %	24
BMI -KFA (D)	1974- 1977	PWR 1300 MWe (KWU)	totally embedded plant (pit siting)	KWU reactor building in a pit 60 m deep with a $\phi = 70$ m	11 - 14 %	17
			semi embedded plant (pit siting)	KWU reactor building in a pit 30 m deep with a $\phi = 70$ m	8 - 10 %	
SECURE reactor (S-SF)	1976- 1977	LWR (pool type) 200 MW _{th}	deep below the surface plant in rock cavities	rectangular rock cavity		

Table 5 - 1 Some characteristics of the main european studies (Ref. 5 - 9)

5.8 CONCLUDING REMARKS

5.8.1. In this chapter, some of the main studies performed in the last years in Europe (with the exception of Switzerland) on the underground siting of nuclear power plants have been examined.

Common motivation to these investigations is to assess the feasibility, the safety potential and the costs of the underground siting.

A summary of the most significant characteristics of these studies is given in table 5 - 1.

5.8.2. Two of the main alternatives of the underground siting, the rock cavity plant and the pit siting, have been examined basing mainly on very detailed plant layouts.

The studies performed in Norway and Sweden have dealt with the rock cavity alternative while the study performed in Germany has dealt with the pit siting.

Mainly as a consequence of one of the main motivations for these studies, the protection against acts of war and sabotage (including terrorism), the studies rely strongly on the additional level of protection and containment offered by the rock overburden or by the backfill.

The CDL study suggests the possibility of having a reactor building cavern open to the atmosphere through shafts equipped with stone beds. The BMI-KFA study suggests instead the possibility to cope with overpressures with an extra-space around the underground reactor building.

References

- 5-1 E. Jamne
Underground siting of nuclear power plants in Norway
Proc. 4th Intern. Conf. Geneva 6-16 Sept 1971 P/290
- 5-2 CDL
Krigsskyddad förläggning av kärnkraftverk
1974
- 5-3 CDL
Rock siting of nuclear power plants from a reactor
safety standpoint
Final report Nov. 1975
- 5-4 Vattenfall
Kärnkraft i Berg
June 1977
- 5-5 Norwegian Water Resources and Electricity Board
Rock cavity construction of nuclear power plant.
Summary of project study
December 1975
- 5-6 KFA
Beurteilung der unterirdischen Errichtung von Kern-
kraftwerken in Boden in einer offenen Baugrube
BMI-SR 44
June 1977
- 5-7 L. Nillson, M. Hannus
SECURE nuclear district heating plant
Topical meeting on low temperature nuclear heat
Otaniemi, Finland, August 21-24, 1977

- 5-8 J.P. Bento, T. Mankamo
Safety evaluation of the SECURE nuclear district
heating plant.
Topical meeting on low temperature nuclear heat
Otaniemi, Finland, August 21-24, 1977
- 5-9 S. Pinto
A survey of underground nuclear power plants
Part 5. The main european studies
TM-ST-566, October 1978

CHAPTER 6

THE MAIN SWISS STUDIES

<u>Contents</u>	<u>Page</u>
6.1 Introduction	6-5
6.2 The Electrowatt A.G. Study	6-7
6.3 The EIR rock cavity plant study (1975)	6-14
6.4 The Motor Columbus PWR study	6-25
6.5 The Motor Columbus HTR study	6-33
6.6 The EIR pit siting study (1976)	6-39
6.7 The EIR pit siting study (1977)	6-42
6.8 The EIR rock cavity plant studies	6-55
6.9 Comparison among the studies	6-65
6.10 Concluding remarks	6-68

6.1. INTRODUCTION

- 6.1.1. The drastic changes recently occurred in the safety evaluation of nuclear power plants, in the licensing process and in the public acceptance of nuclear power have made the underground siting again attractive in some respects, also in Switzerland.

Various engineering consultant companies, taking advantage of the experience acquired with the construction and exploitation of underground hydroelectric plants and of the Lucens experimental station have performed studies to evaluate the feasibility of the siting, to identify possible advantages and disadvantages of the various concepts and to point out areas needing further investigations.

The main studies recently performed in Switzerland on the underground siting of nuclear power plants are briefly described in this chapter.

- 6.1.2. The Swiss Federal Institute for Reactor Research (EIR) has been very active in this field with a long research program that has allowed to investigate in some detail the main aspects of the underground siting.

The main aim of these studies has been infact directed at identifying suitable alternatives and at evaluating the feasibility, the safety potential and the costs of the siting.

Detailed layouts have been proposed for plants located

both totally and partially underground, basing on light water reactors.

Within the scope of this general investigation of the underground siting concept, an evaluation of alternative containment systems has been made.

This investigation has allowed a quantification of the potential risk reduction offered by the underground siting in the case of major hypothetical accidents.

6.2. THE ELECTROWATT STUDY

6.2.1. This study has been performed in 1972 by Electrowatt Engineering Services Ltd. (Ref. 6 - 1).

The main aim of this study was to investigate and discuss the possible reasons leading to the underground siting of a nuclear power plant and to estimate the cost increase due to such a construction.

Moreover, two possible alternatives of the rock cavity plant concept have been proposed both for a PWR and for a BWR, rated 1000 MWe.

6.2.2. According to this study, the main possible reasons for the construction of an underground nuclear power plant are

- the proximity to energy users and / or load distribution centers
- the possibility of power generation during war time
- a minimal impact on the environment
- the reduced possibility of sabotage acts
- the protection against external missiles
- "nuclear safety"

The conclusions of the study are that today there is no necessity to locate a nuclear power plant underground except for the case when power production is required during wartime.

If, however, a nuclear power plant must be located underground, the urban siting is the most logical choice because no site criteria are available for this type of siting (and the existing ones are clearly not applicable) and also because, in this case, a surface plant would not be accepted by the general public.

6.2.3. In this study only the rock cavity plant concept has been taken into account. However, both the hillside alternative and the deep below the surface alternative have been considered (Fig. 6 - 1 to 6 - 4) for plants located totally or partially underground.

The choice of the alternative is dependent on the site topography while the plant sections to be built underground are determined by economical, licensing and psychological reasons.

The hillside disposition should not present any particular problem since adequate experience is available from the existing underground nuclear plants and hydraulic installations. The deep below the surface disposition (with access through vertical shafts) instead, is a new concept that presents some new technical problems to be solved.

6.2.4. The dimensions of the reactor cavern, cylindrical in shape with a dome are, for a 1000 MWe PWR, 35 m inner diameter and 63 m height. For a BWR of the same power rating, the dimensions are 48 m inner diameter and 72 m height.

The depth of burial should be determined by the computed

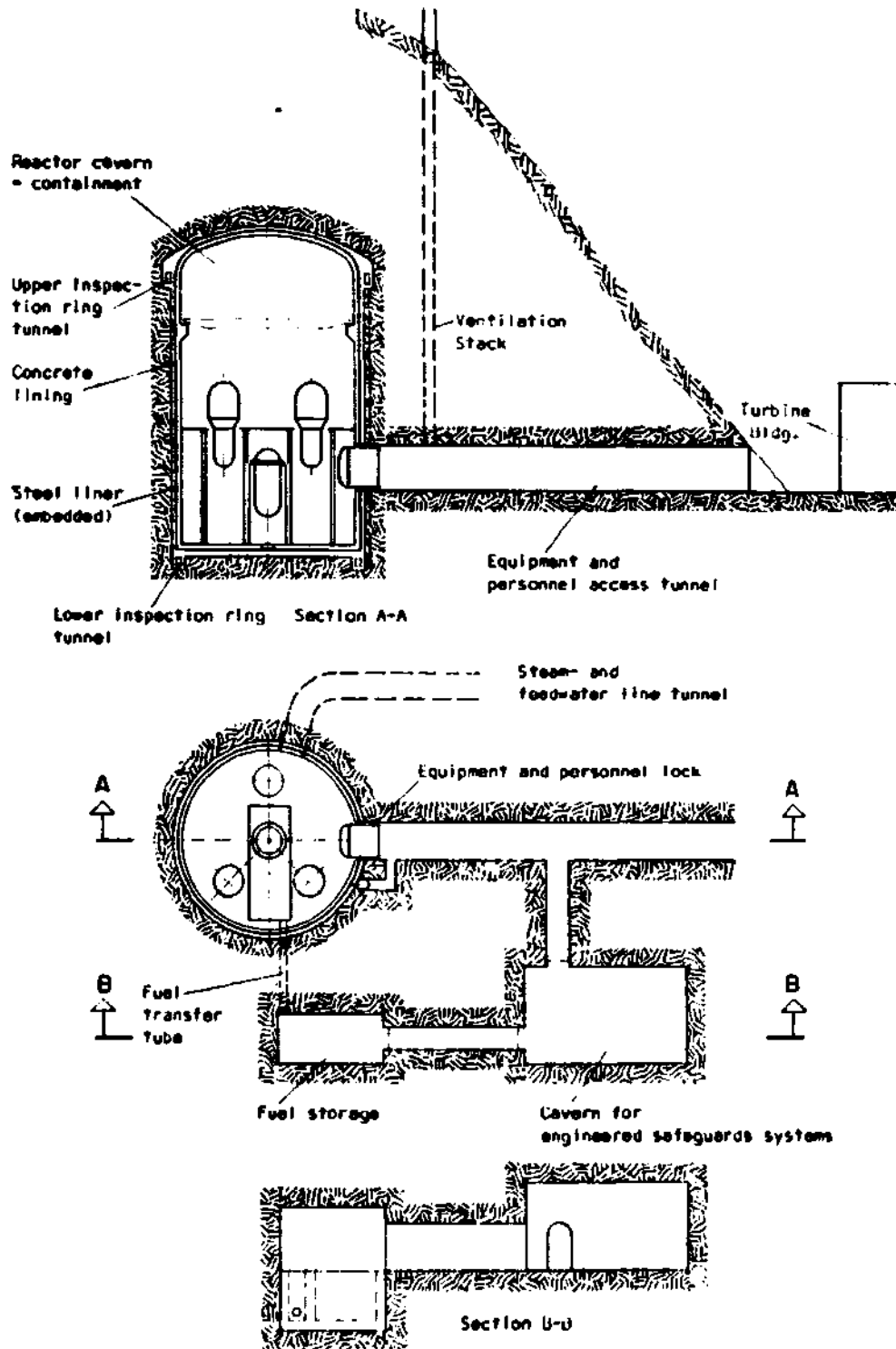

Fig. 6 - 1 Underground PWR - hillside disposition

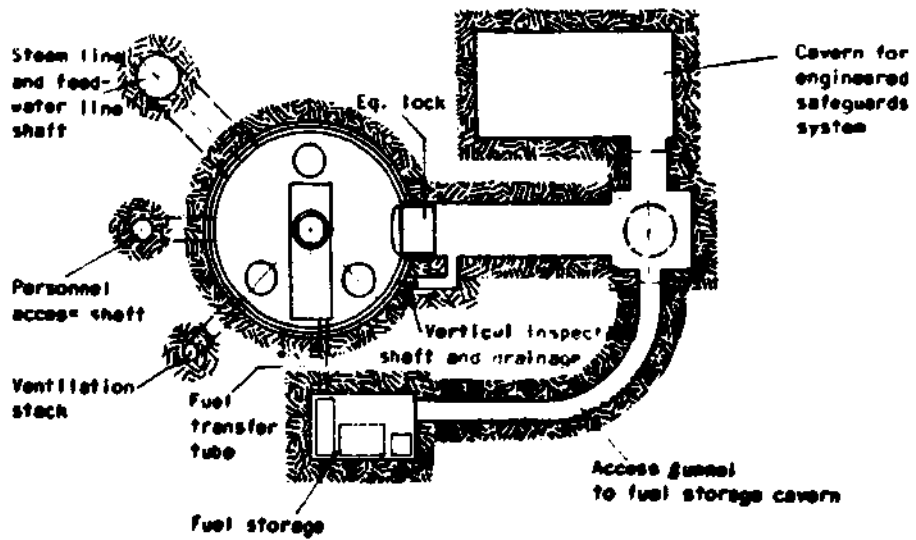
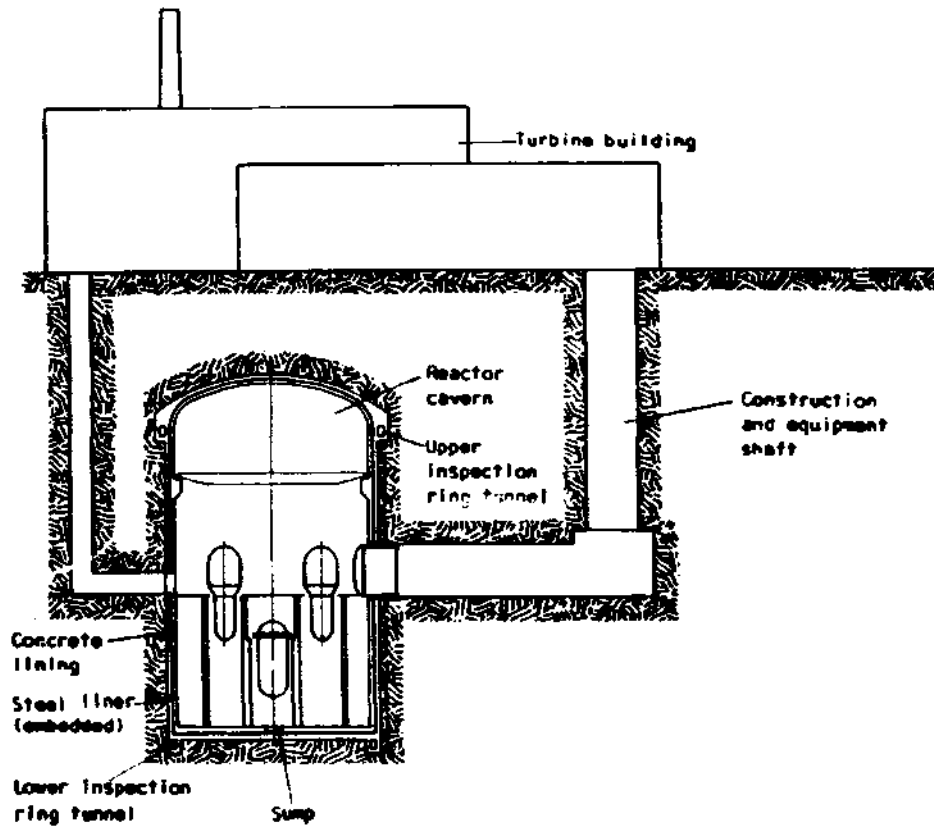

Fig. 6 - 2 Underground PWR - deep below the surface disposition

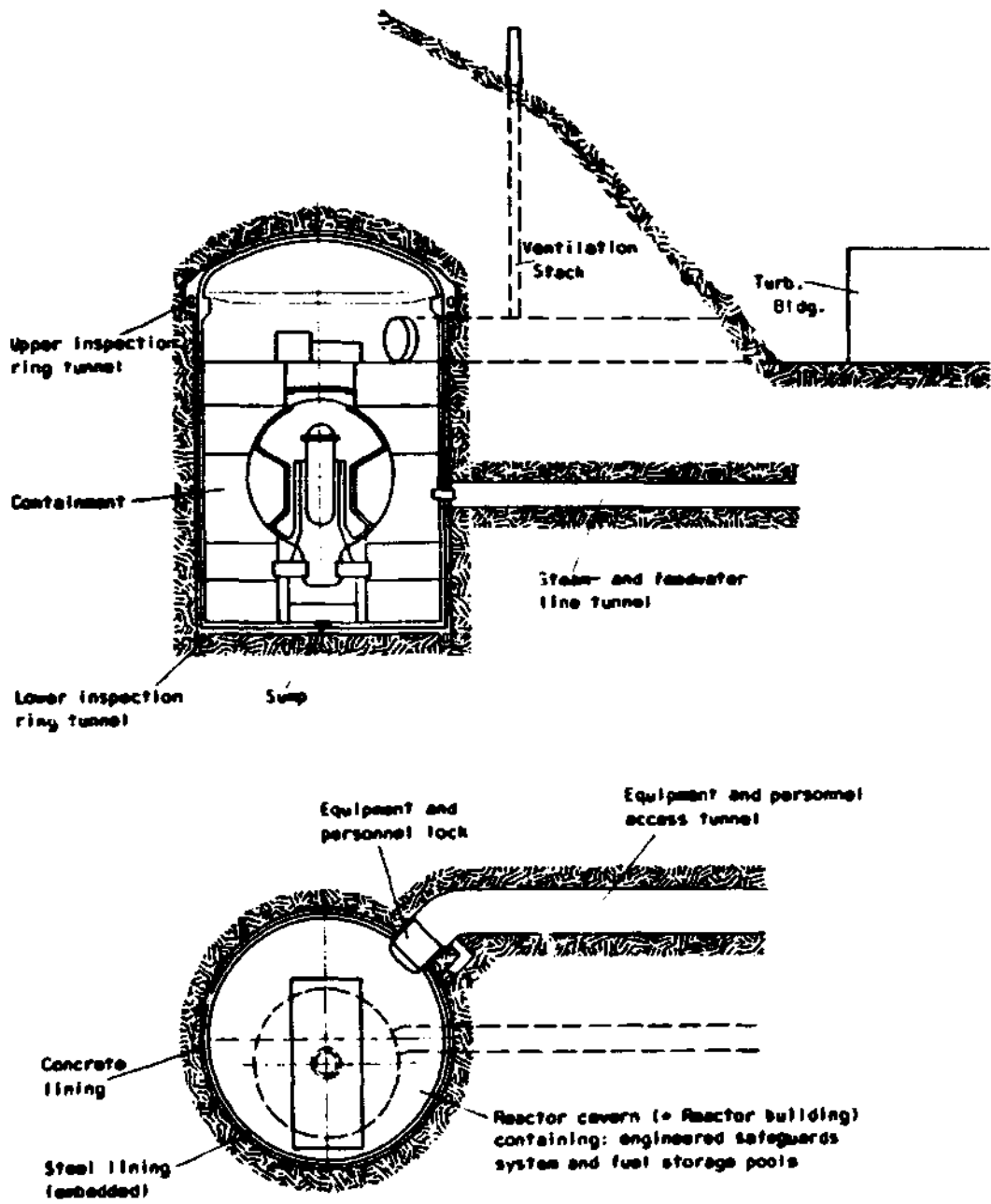

Fig. 6 - 3 Underground BWR - hillside disposition

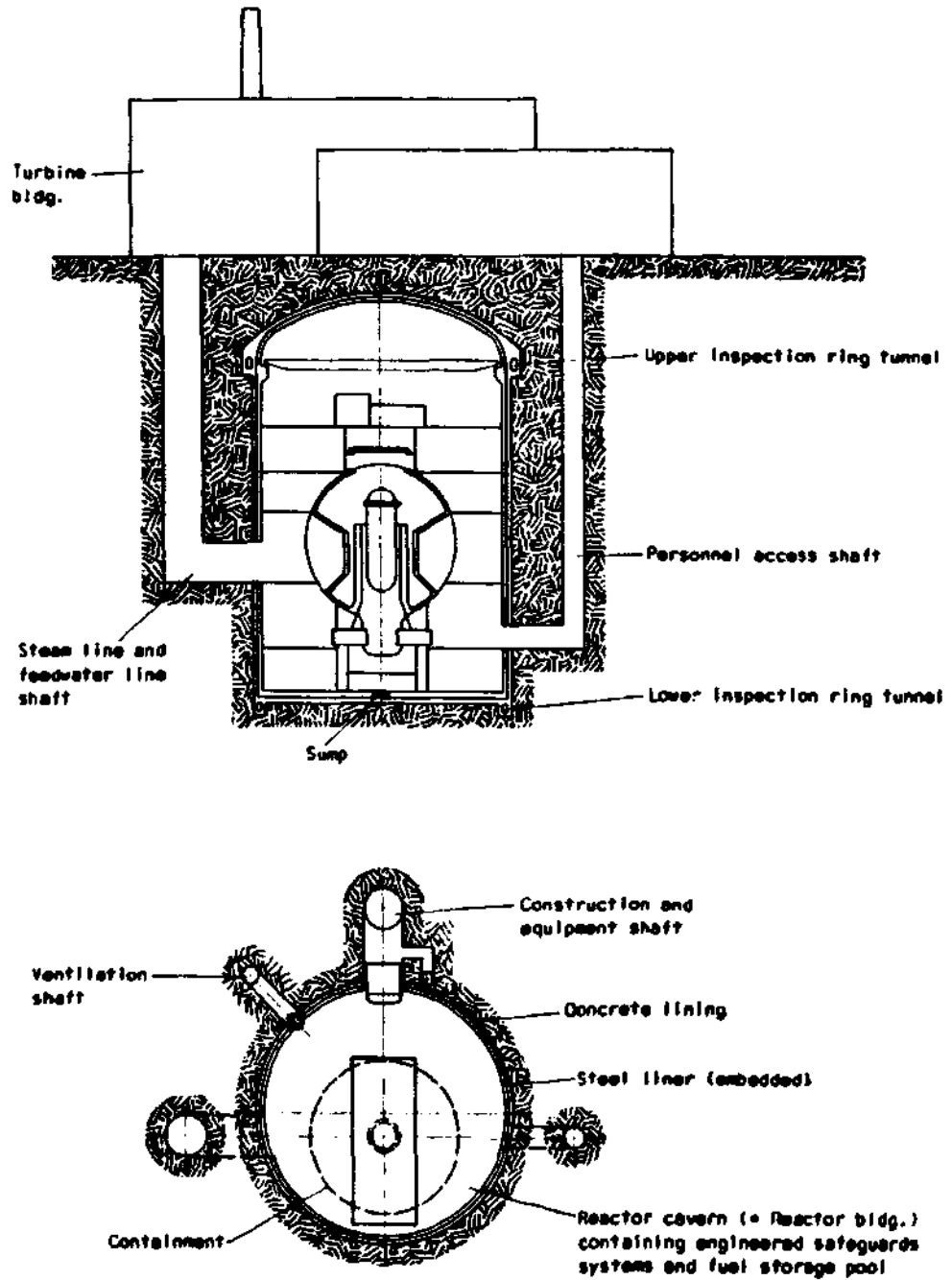

Fig. 6 - 4 Underground BWR - deep below the surface disposition

peak accident pressure (for the PWR plant since the BWR plant has a pressure - suppression containment), by the expected external events (including war), by shielding requirements.

In the case of the PWR, the rock should contribute to the containment strength.

A liner, with the function of preventing both water seepage in and out of the reactor cavern should be provided for.

6.2.5. Additional expenses are met for the underground siting of a nuclear power plant mainly due to the excavation of caverns and galleries, drainage and sealing systems, higher erection and installation cost, longer cables and piping etc.

The study has estimated that, for Swiss conditions, the cost increase for the structural portion of the plant alone is about 45 - 50 % for both types of reactors and plant dispositions.

6.3. THE EIR ROCK CAVITY PLANT STUDY (1975)

6.3.1. This study on the underground siting of nuclear power plants - with emphasis on the rock cavity plant alternative - was performed by the Swiss Federal Institute for Reactor Research (EIR) in 1975.

The study, based on a pressurized water reactor rated about 1000 MWe, was meant as a first phase of a more general investigation of the underground siting. (Ref. 6 - 2). Main aim of this first phase was to investigate, from the constructional point of view, the possibility of building a nuclear power plant in rock caverns.

In this study the whole nuclear power plant, with the exception of the cooling tower, is assumed to be located underground to achieve a better protection against acts of war.

The possibility of using artificial lakes for cooling purposes has also been considered (Ref. 6 - 3).

6.3.2. The following containment alternatives have been investigated (Fig. 6 - 5):

alternative I, a freestanding containment in a cavern with two different construction concepts:

Ia, a steel containment about 30 - 33 mm thick

Ib, a prestressed concrete containment with a steel liner

alternative II, a containment supported by the rock with two different construction concepts:

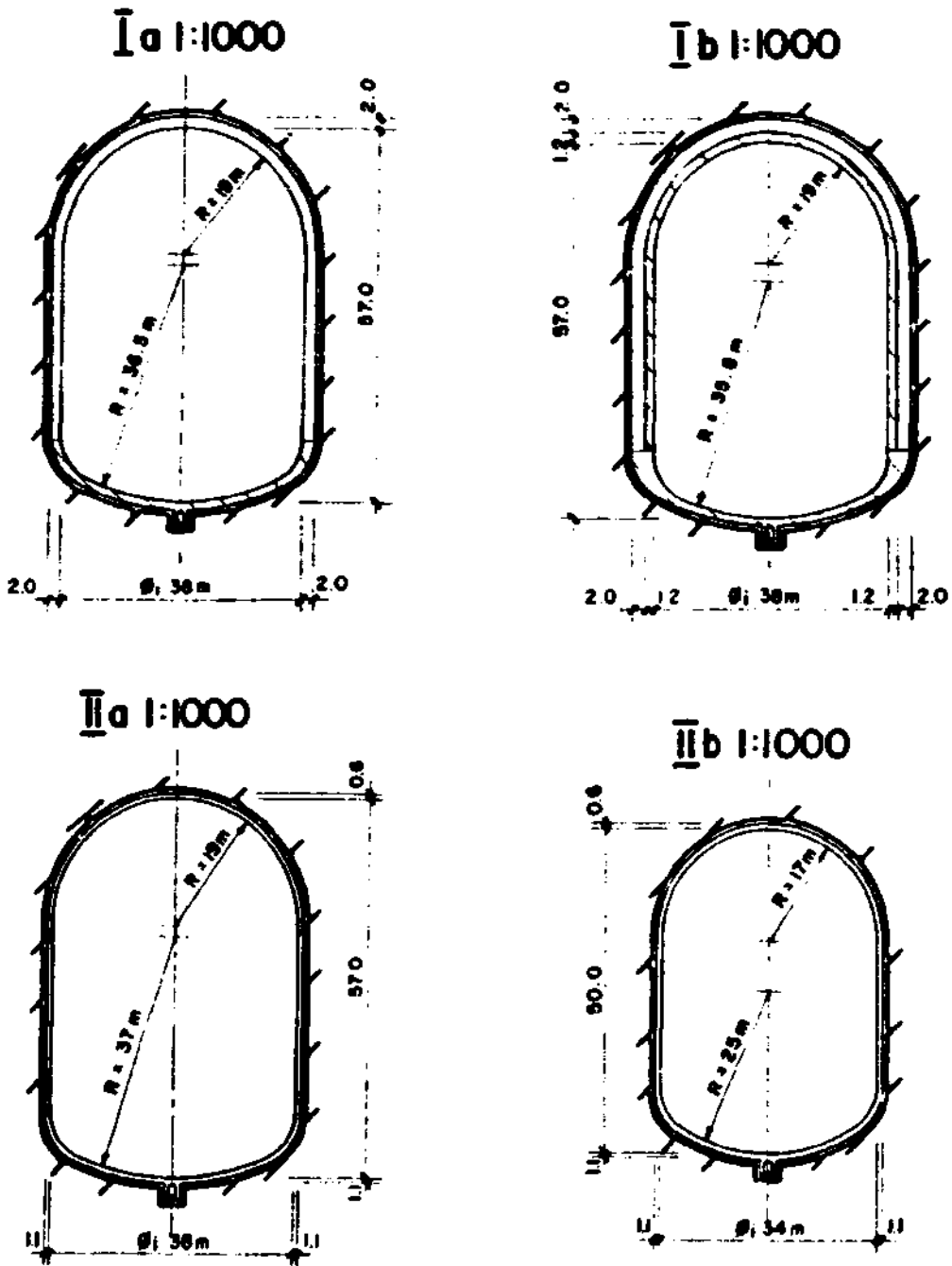

Fig. 6 - 5 Investigated containment alternatives

IIa, a containment with the same internal dimensions of the steel containment as alternative Ia (also with the same design pressure)

IIb, a smaller containment designed on the basis of the minimal space requirements for the components of the primary loop

Alternative Ia leads to a double containment system as in swiss or german PWRs. The steel containment is designed to withstand the overpressure that can be created in the containment by a loss of coolant accident. The rock cavern can be considered as the secondary containment. Infact the cavern protects the steel containment from external events and plays the role of an additional barrier against releases of radioactive fission products.

This alternative has the advantage that the primary containment can be inspected and controlled from the outside.

Alternative Ib corresponds to the underground siting of a typical full pressure containment as realized at present in the majority of US pressurized water reactors.

The containment walls are prestressed and designed to withstand the overpressure of a loss of coolant accident. A steel liner, about 10 mm thick, placed against the concrete walls is the barrier that prevents the release of gaseous radioactive products.

This containment concept does not appear to be the most appropriate for a rock cavity plant. Infact, it does not show any essential advantage if compared with alternative Ia but requires a larger cavern span of about 3 - 4 m.

Alternative IIa requires a containment of the same dimensions as alternative I: it is therefore designed to withstand the same overpressure created by a loss of coolant accident, but utilizes the rock directly as containment walls. The rock will be covered with a layer of concrete in which accessible galleries are provided for. A steel liner is placed against the concrete walls.

This alternative has the advantage of requiring a smaller cavern (with a 2 - 3 m shorter span) than the alternative Ia. Moreover, since the building structures are supported by the rock, a higher safety degree against overpressure can be achieved.

Alternative IIb is an attempt to utilize the rock properties to cope with high internal overpressures, reducing significantly the dimensions of the containment cavern.

The reactor cavity is dimensioned on the basis of the space requirements for the components of the primary loop and requires therefore a smaller free volume than the other alternatives previously mentioned.

In the case of a loss of coolant accident the reactor cavern, in this alternative, will be subjected to a higher overpressure that, however will be taken up by the rock.

Alternative Ia and IIb have been further investigated in the study. Infact these two alternatives are two extreme solutions for what concerns the containment dimensions, the necessary construction techniques and also for the costs.

- 6.3.3. Various possible arrangements of the caverns and connecting tunnels and galleries have been investigated. The proposed plant layout, based mainly on constructional considerations, is represented in Fig. 6 - 6, to 6 - 8.

The arrangement of the three main large caverns and of the reactor containment has been chosen in such a way as to keep the connecting tunnels, cables and piping as short as possible. Furthermore, this layout allows the simultaneous excavation of the main caverns.

In the reference case (alternative Ia) the reactor cavern, cylindrical in shape with a dome, is 62.3 m high with a diameter of 42 m.

A long access tunnel, dimensioned for the transport of large components connects this cavern with the outside. This tunnel runs through the electrical equipment cavern.

- 6.3.4. The turbine cavern is horseshoe shaped and has a maximum height of 40 m, a maximum width of 30 m and a length of 140 m. An access tunnel, 6 m wide and 7 m high, runs into the cavern at the turbine floor elevation. A second tunnel for the transmission of electrical energy from the transformers with high tension cables (380 V) is provided for.

The turbine cavern is connected with the containment through steam and feed water ducts and with the electrical equipment cavern through a connecting gallery and cables ducts. Moreover, two galleries, utilized for the cooling water feed and return, run from one side into the turbine cavern at the condenser floor elevation.

The length of these galleries is strictly dependent on the local characteristics of a specific site. In the study a length of 500 m has been taken.

The space requirements of the turbogroup have been reduced with a different arrangement of the water separator - reheaters. The turbine, that occupies the central area of the cavern, is located slightly alongside of the cavern axis to leave free the space necessary for components erection. At one end of the turbine cavern, towards the access, at the groundfloor elevation there are three one - phase transformers, with the free space necessary for replacement, and the circuit breakers. Various auxiliary infrastructures as workshops, warehouses etc. are arranged in several stories above the turbine hall.

- 6.3.5. The auxiliary systems cavern contains all those systems and equipment necessary for a safe reactor operation and for a safe fuel elements and radioactive waste handling. The dimensions of this horseshoe shaped cavern are 150 m length, 26 m maximum width and 34.5 m maximum height.

The auxiliary systems cavern is connected to the containment by means of a personnel tunnel and the gallery for fuel transfer.

These tunnels are arranged at different elevations. The auxiliary systems cables run through the personnel tunnel. A tunnel permitting road transports to enter the fuel handling area in the cavern is provided at the same elevation of the main access tunnel.

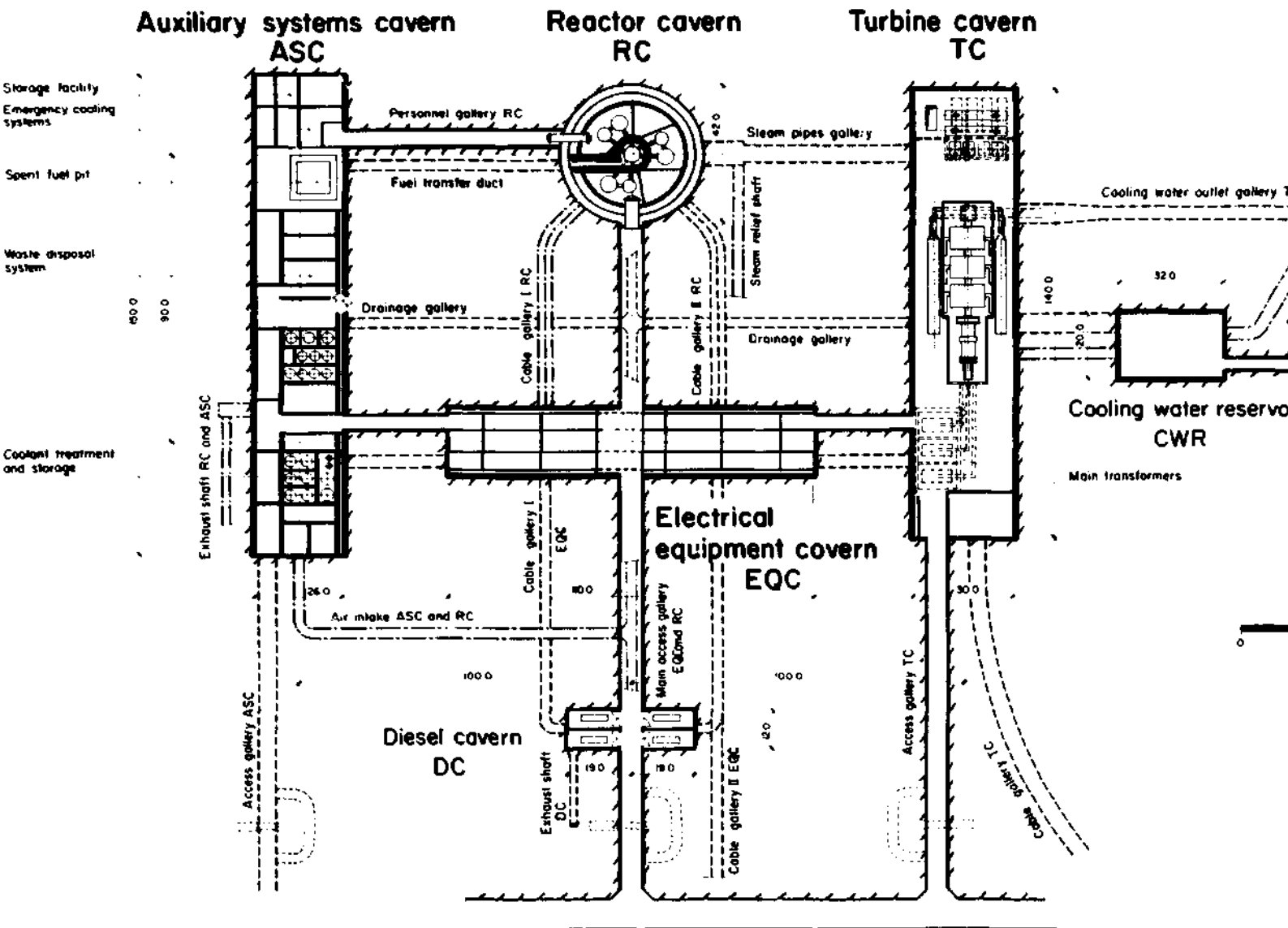

Fig. 6 - 6 EIR rock cavity plant layout: plan

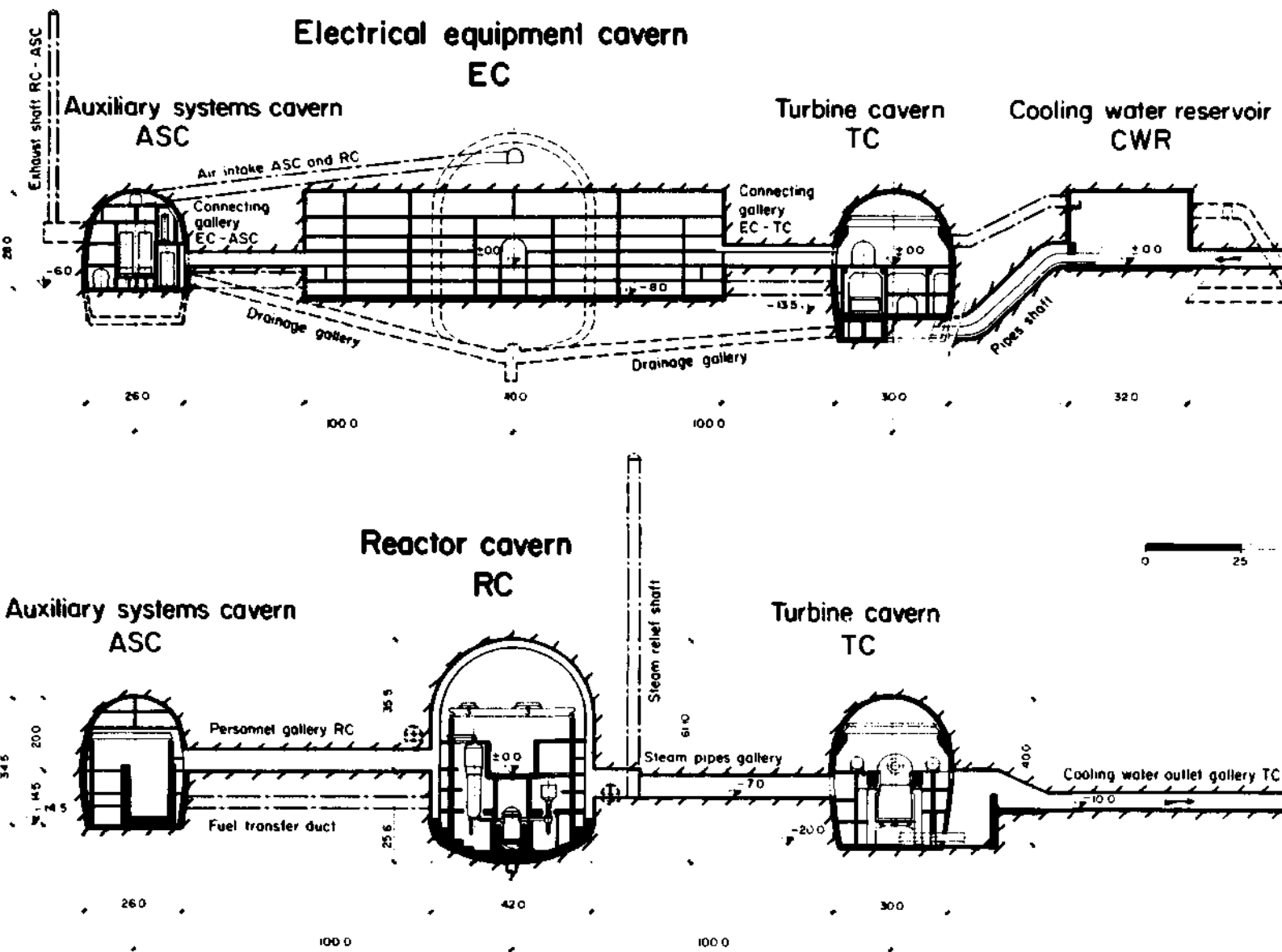

Fig. 6 - 7 EIR rock cavity plant layout: sections

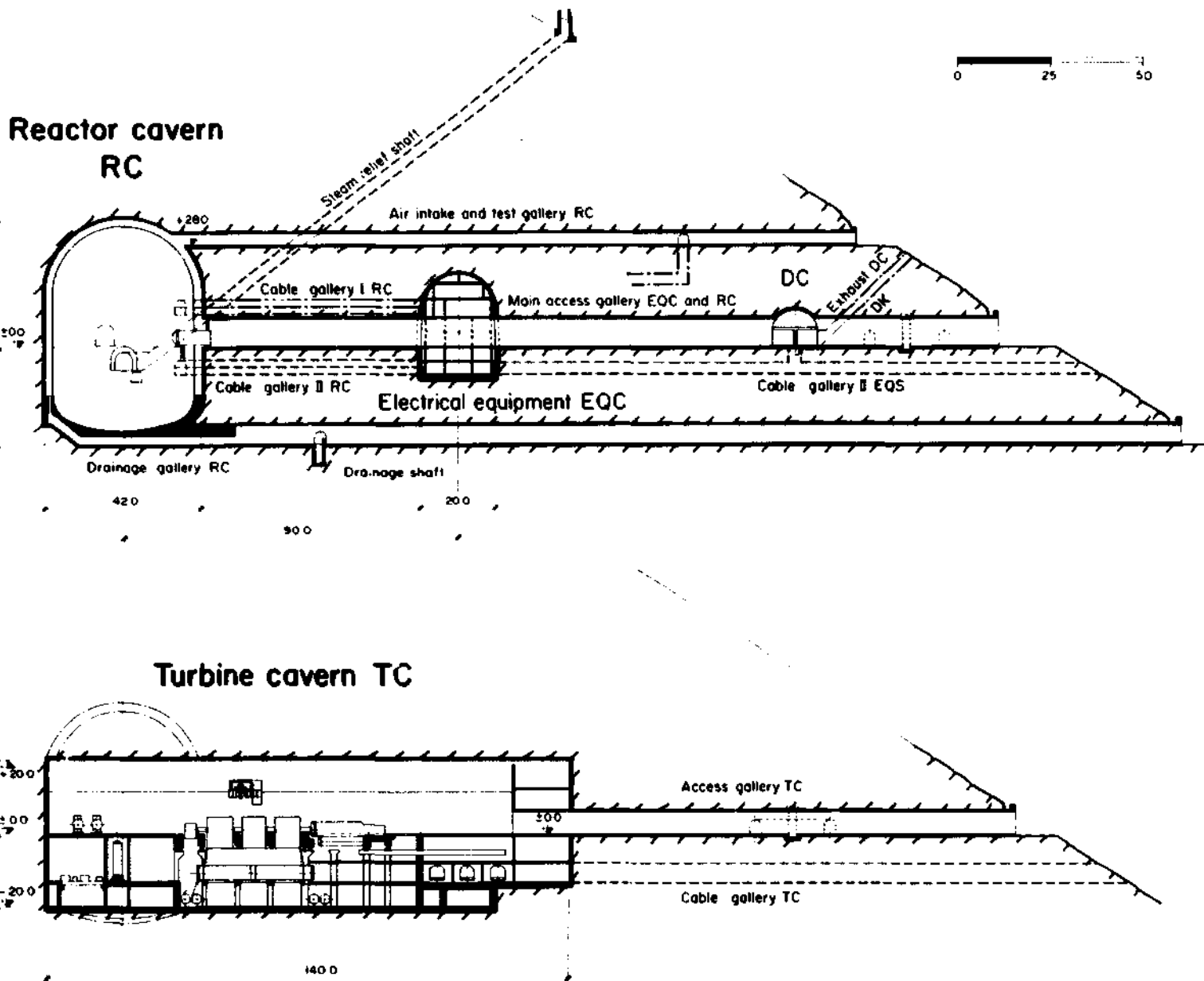

Fig. 6 - 8 EIR rock cavity plant layout: sections

6.3.6. The systems necessary for the plant power requirements and supply are located in the electrical equipment cavern.

This cavern, which has a horseshoe shape like the other main caverns, has been orientated differently. Its axis in fact is perpendicular to the axes of the turbine cavern and of the auxiliary systems cavern.

The main dimensions are 110 m length, 20 m maximum width and 28.5 m height.

Cable connections between the electrical equipment cavern and the containment are through two symmetrically arranged galleries. These galleries are divided by fire walls in four areas: in that way a complete separation of redundant supply systems can be ensured also outside the electrical equipment cavern. A similar cable gallery is provided for between the electrical equipment cavern and the auxiliary systems cavern.

Two personnel tunnels connect the electrical equipment cavern with the auxiliary system cavern and the turbine hall.

6.3.7. The study has dealt mainly with constructional problems. Cavern excavation techniques as well as construction procedures and equipment erection solutions have been proposed.

Since the reactor cavern requires a span by far larger than the largest man made cavern, various rock mechanics calculations have been made (Ref. 6 - 4) for a cavern with dimensions as those required for alternative Ia.

The conclusions of this preliminary analysis are that

- the rotational symmetry of the reactor cavern is, from the constructional point of view, more favourable than long caverns with horizontal axes
- only compressive stresses occur at the excavation boundary and in the medium
- the largest calculated compressive stresses, with a maximum value of 1000 Mp/m^2 , are modest

The problems to be solved for the construction of the reactor cavern are therefore considered to be the same and of the same order of magnitude as those met in the construction of large underground hydroelectric plants.

6.3.8. This first investigation has shown the feasibility of the construction in rock cavities of a nuclear power plant rated about 1000 MWe. The caverns necessary to house the various plant components and especially the cavern for the reactor building, can be excavated utilizing the well known and proven technology of underground construction.

However the underground siting requires a longer construction time and higher costs than the conventional surface siting. The construction time, for the proposed plant, has been evaluated to be about 24 months longer while the costs are about 11 % higher.

6.4. THE MOTOR COLUMBUS BWR STUDY

6.4.1. This study, performed by Motor Columbus Consulting Engineers Inc. and partially financed by EIR, has been completed in 1975 (Ref. 6 - 5).

The study has investigated in a general way a BWR located totally underground in rock cavities. The standard General Electric 3000 MWth BWR6 reactor with a Mark II containment was chosen as reference plant.

A specific site has been chosen for the plant. The site is in a large pre-alpine valley in south-western Switzerland, about 1.5 km from a river with sufficient minimum flow rate to ensure the necessary amount of make-up water for the plant cooling towers and for emergency after-heat removal.

In this investigation main emphasis has been given to

- plant operability during conventional warfare
- protection against external events
- compliance with actual licensing requirements

6.4.2. The plant layout is represented in Fig. 6 - 9 to 6 - 11. All those systems and components which, after being damaged, require a repair time longer than one month have been located underground. Furthermore, departures from the reference layout have been limited to the minimum in order to maintain the same operational and safety characteristics of the surface plant.

In determining the plant layout special attention has been given to the following constructional and operational aspects:

- the plant should be located in horizontal caverns excavated slightly above valley floor level. The caverns should be parallel to each other and perpendicular to the valley axis, this arrangement being favourable from the rock mechanics point of view
- the number of caverns should be limited to a minimum in order to reduce the number of connecting tunnels
- the caverns excavation span should be limited to 35 m. In fact caverns of such a span can be built in good quality rock without great technical difficulties
- the distance among the caverns should be such as to leave enough sound rock to bear the stresses created by the excavation of caverns and tunnels.

6.4.3. The chosen plant configuration consists of two main parallel caverns with separate access tunnels. A smaller tunnel used as escape route is located between the caverns.

The reactor cavern houses the reactor containment, all auxiliary systems, the fuel handling systems, the energy supply systems and the plant control room, the diesel generators, the component cooling system, the water treatment plant.

This cavern has an excavation diameter of 35 m and a total length of about 200 m. Its height varies from a maximum

- | | | | |
|------------------------------|---------------------------------|---------------------------------------|---|
| 1 REACTOR BUILDING | 12 CONTROL ROOM | 23 STEAM PIPES DUCT | 34 ACCESS TUNNEL |
| 2 REACTOR | 13 WATER TREATMENT | 24 COMPONENT COOLING SYST. WATER DUCT | 35 TANKS |
| 3 FUEL STORAGE POOL | 14 LABORATORIES | 25 TURBINE CAVERN | 36 AIR INTAKE PLANT |
| 4 NEW FUEL STORAGE VAULT | 15 DEMINERALIZED WATER TANKS | 26 TURBINE | 37 MAIN GATE |
| 5 EQUIPMENT HATCH | 16 EMERGENCY DIESELS | 27 GENERATOR | 38 EXHAUST SHAFT |
| 6 AUXILIARY SYSTEMS BLDG | 17 DIESELS | 28 EQUIPMENT HATCH | 39 COMPONENT COOLING SYST. MAIN PIPES |
| 7 DECONTAMINATION AREA | 18 REACTOR CAVERN ACCESS TUNNEL | 29 TRANSDUCER BLDG | 40 COMPONENT COOLING SYST. AUX. PIPES |
| 8 CONTROLLED CHANGING AREA | 19 WAREHOUSE | 30 WORKSHOP | 41 ASSEMBLY HALL |
| 9 UNCONTROLLED CHANGING AREA | 20 EXHAUST SHAFT | 31 SPG SWITCHGEAR | 42 AVE. AIR INTAKE |
| 10 ACCESS CONTROL | 21 ESCAPE TUNNEL | 32 CIRCULATING WATER PUMPHOUSE | 43 CIRCULATING WATER FEED |
| 11 ELECTRICAL BUILDING | 22 EXHAUST CHIMNEY | 33 CABLES DUCT | 44 CIRCULATING WATER RETURN |
| | | | 45 CIRCULATING WATER TO THE COOLING TOWER |

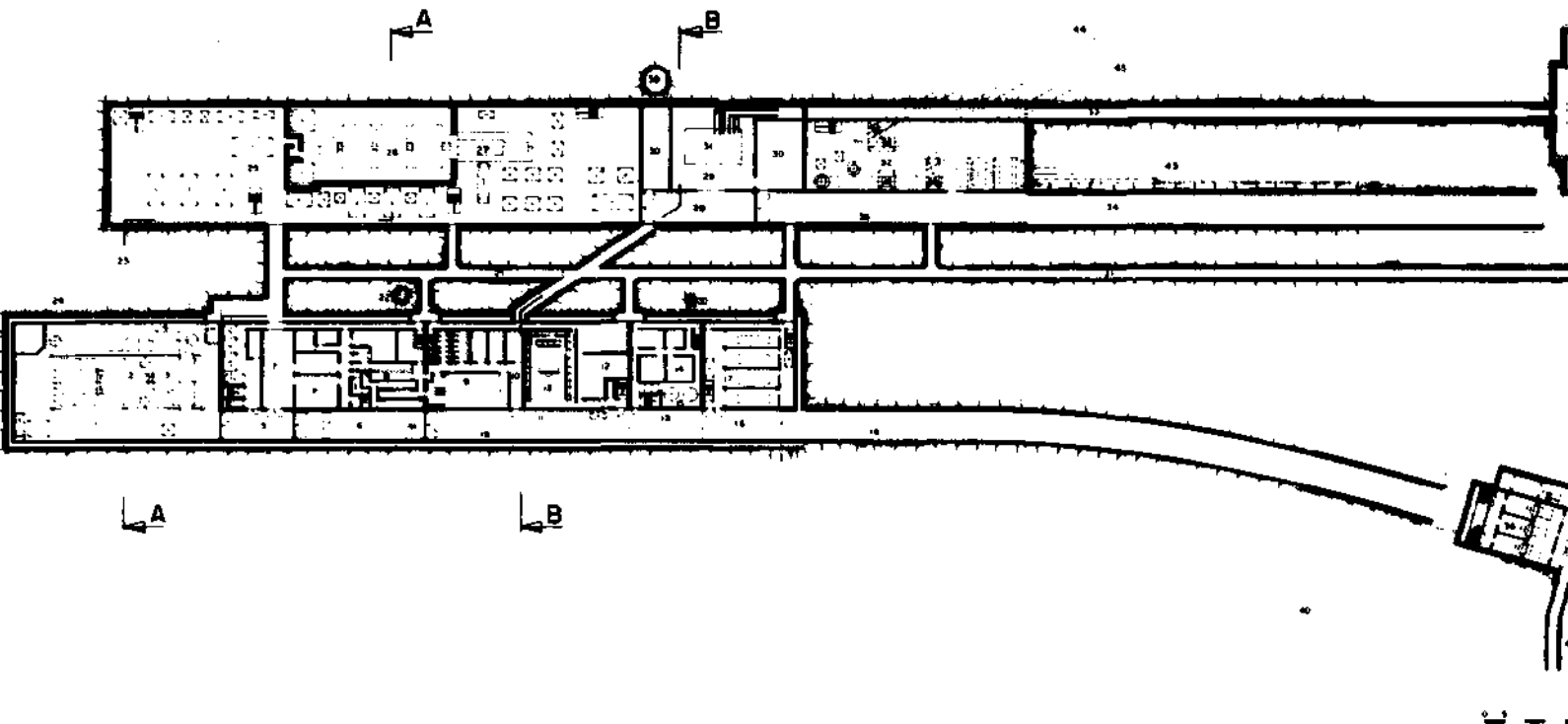

Fig. 6 - 9 BWR in rock cavities: plan

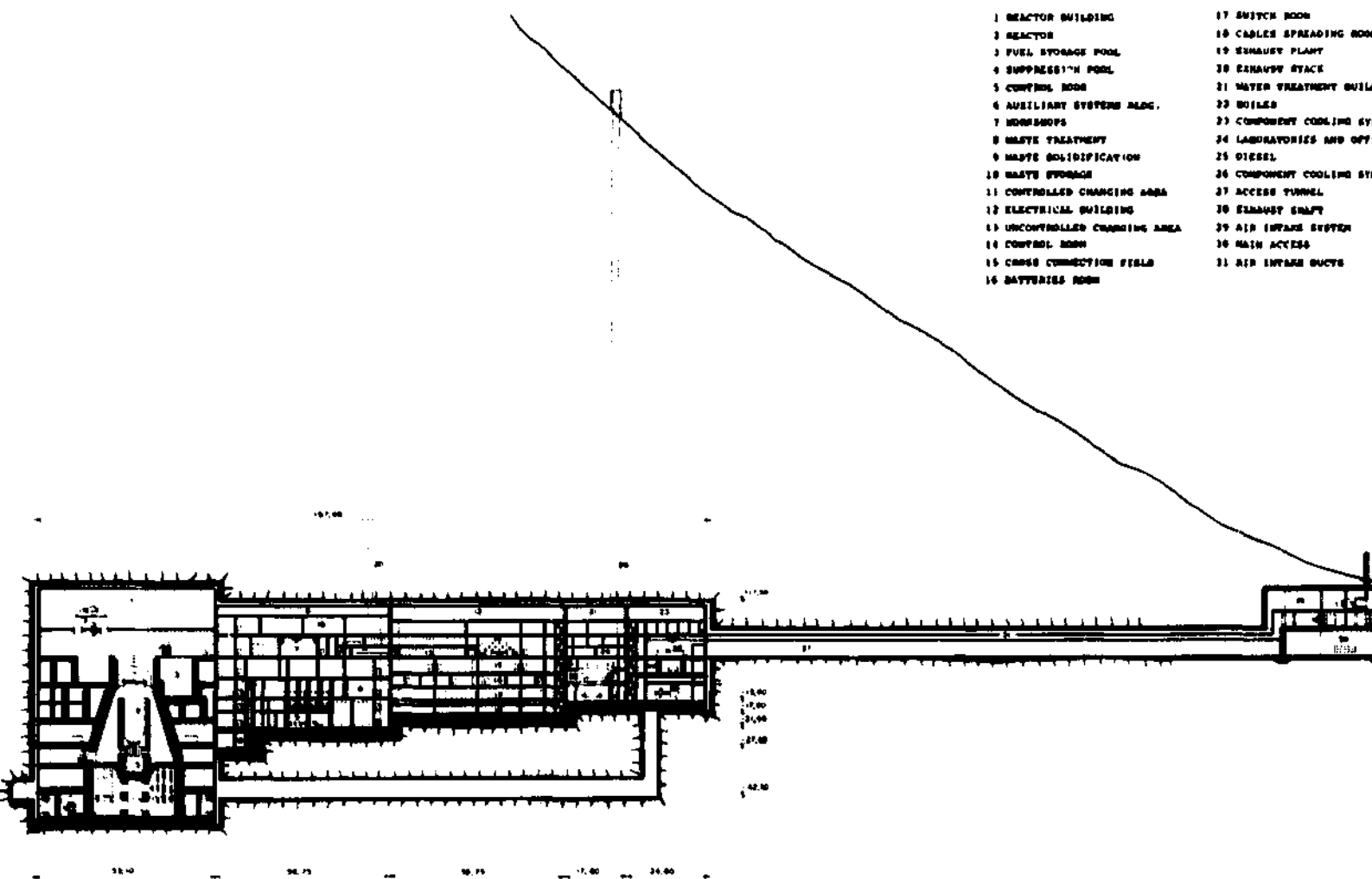
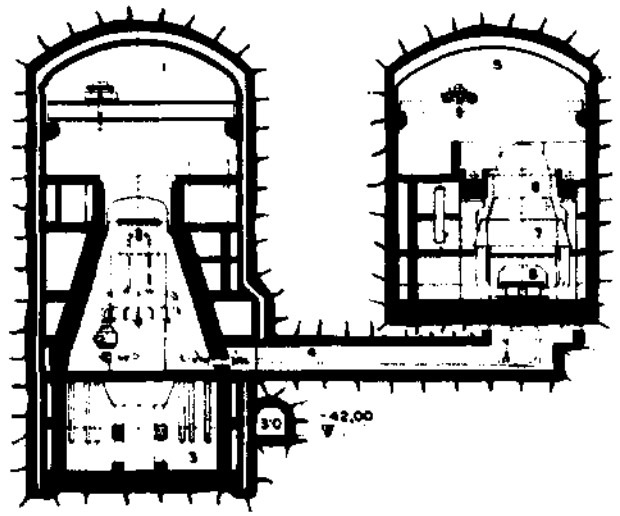

Fig. 6 - 10 BWR in rock cavities: section

- | | |
|---------------------------|---------------------------------|
| 1 REACTOR BUILDING | 12 BATTERIES ROOM |
| 2 REACTOR | 13 SWITCHGAP |
| 3 SUPPRESSION POOL | 14 CABLE SPREADING ROOM |
| 4 STEAM PIPES DUCT | 15 CABLES DUCT |
| 5 TURBINE CAVERN | 16 CONNECTING GALLERY |
| 6 TURBINE | 17 TRANSFORMERS BLDG |
| 7 CONDENSER | 18 MAIN TRANSFORMER |
| 8 CIRCULATING WATER FEED | 19 SF6 SWITCHGEAR |
| 9 ELECTRICAL BUILDING | 20 EXHAUST SHAFT |
| 10 CONTROL ROOM | 21 CIRCULATING WATER PIPES |
| 11 CROSS CONNECTION FIELD | 22 COMPONENT COOLING PIPES DUCT |

23.00
10.00
7.60
18.40
25.40
31.30
38.30
47.70



20.00
0.00
4.00
11.50
20.00
27.00
31.90

section A-A

11.00
7.00
0.00
4.50
6.50
12.50
17.00

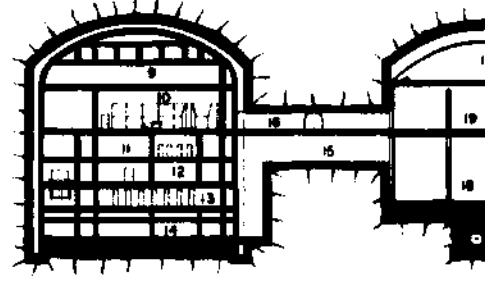

30
42.00

section B-B

Fig. 6 - 11 BWR in rock cavities: sections

of 75 m in the reactor containment section to a minimum of 35 m in the diesel generators and auxiliary pumps section.

The turbine cavern houses the turbine plant, the main transformers with the switchyard, the main cooling water pumps and a workshop. This cavern is 32.5 m wide, 228 m long and 47 m high in the turbine hall area and 35 m in the cooling water pumps section.

- 6.4.4. The G.E. Mark II containment has been arranged in the reactor cavern without structural modification. A certain amount of rearrangement however has been found necessary for some ancillary equipment and for the equipment hatch.

In order to ensure and simplify the containment insulation against inleakage water, a double containment system has been proposed. The primary containment building consists of a freestanding 0.5 m thick reinforced concrete structure. The cavern walls, lined with a 0.8 m thick concrete layer, represent the secondary containment.

An interspace, about 1.2 m wide, between primary and secondary containment is mainly used for inspecting the water insulation on the outer surface of the reactor building. This double wall system is applied not only for the reactor containment but for the whole reactor cavern.

The turbine cavern has a simpler structure with a conventional rock wall lining. Only the roof has a double lining with an interspace for inspection.

Since the turbine cavern span has been limited to about 30 m, some rearrangements of components and equipment has

been necessary. For instance, the turbogroup has been located slightly alongside of the cavern axis, the feedwater tank - deareator has been eliminated due to lack of space (degassing of the condensate is made by addition of chemicals in the low pressure feed water heaters) etc. In spite of these modifications there are no constraints for what concerns accessibility and maintenance.

6.4.5. In order to satisfy the requirement of plant operability during wartime, while still satisfying the swiss water pollution regulations, the plant cooling system has been devised with two modes of operation:

- recirculation through forced draft cooling towers, located on the surface, for normal operation
- once - through cooling with river water for wartime operation

All the equipment necessary for this last operation mode, as main pumps, filters, water intake and outlet etc. are located underground.

6.4.6. In spite of its character of preliminary investigation, this study shows that the siting in rock cavities of a 1000 MWe BWR with a Mark II containment is possible for good or medium quality rock, without excessive difficulties. Even if the siting requires modifications of the overall plant layout, it is possible to maintain the standardized design of the nuclear steam supply system and to have, throughout the whole plant, the same degree of operational safety as in above ground facilities.

Due to the underground siting, the plant construction time is extended by 18 - 24 months. The associated cost increase has been estimated to be about 25 - 30%.

6.5. THE MOTOR COLUMBUS HTR STUDY

6.5.1. This study was performed by Motor-Columbus Consulting Engineers Inc. in 1975/76 as in an in-house study (Ref. 6 - 6). The investigation considered the technical and economical feasibility of an underground location of a Gulf General Atomic 1160 MWe six - loop HTGR. The study was an extension of the previous study of an underground BWR (§ 6.4.).

The aim of the investigation was to establish a design concept for urban siting which could provide a maximum amount of public safety and which could be utilized for process heat and district heating. The HTR was at that time considered particularly suitable for this role.

6.5.2. A basic design criterion was as low as practical radioactive release, taking into consideration earthquake, flooding, airplane crash and conventional bombing.

A specific site typical of the lower but hilly parts of Switzerland was chosen for the study. The reactor with service building and fuel store was located underground. For this specific site it was found to be more economical to locate the turbogroup and other conventional portions of the plant outside the hill.

The location necessitated the use of a cooling tower but river water could be supplied for emergency cooling.

The geological site conditions are characterized by horizontally bedded sandstones and marls of the upper

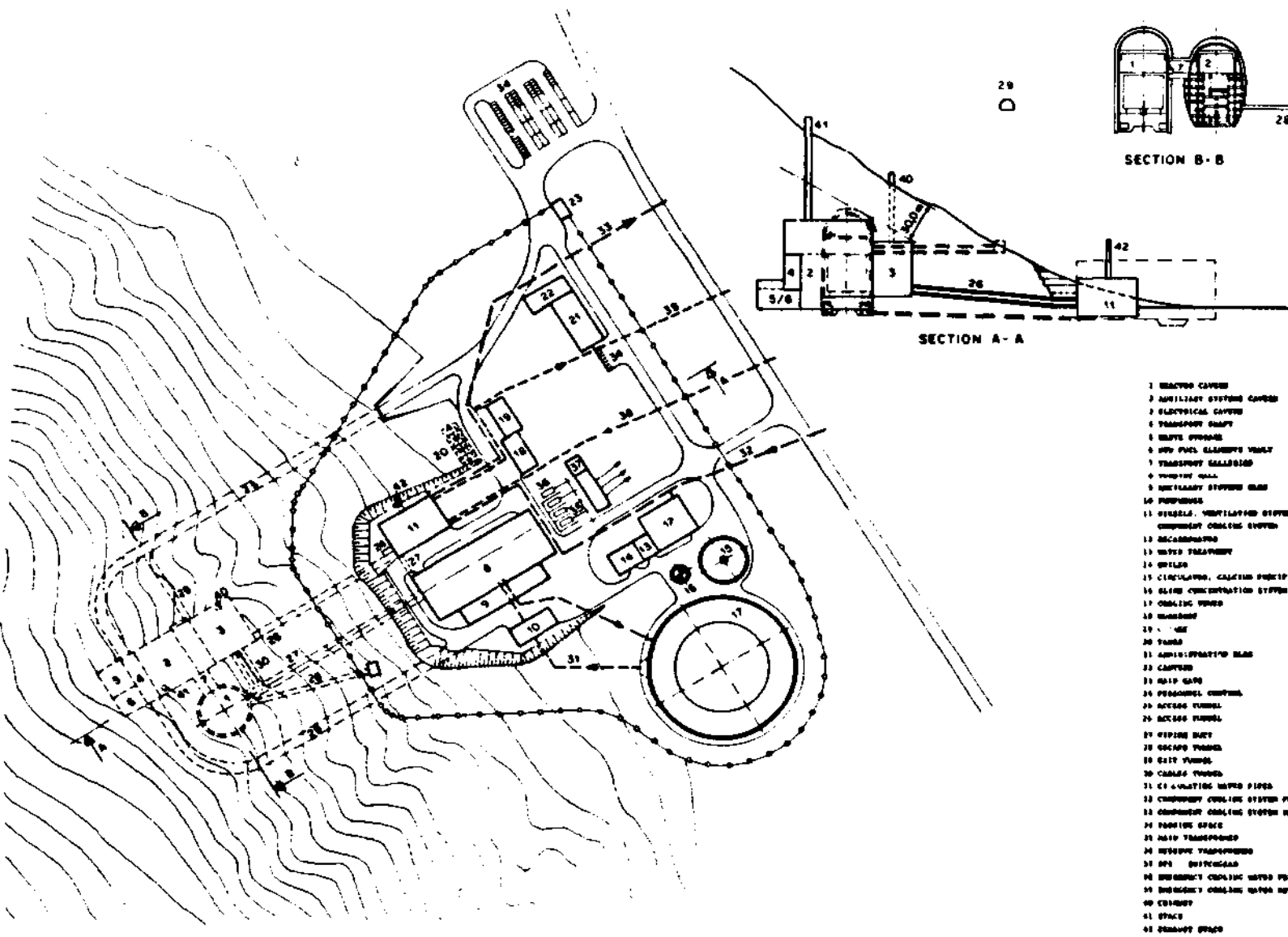

SECTION B-B

SECTION A-A

- 1 REACTOR COVER
- 2 AUXILIARY SYSTEM COVER
- 3 ELECTRICAL COVER
- 4 TRANSPORT SHAFT
- 5 SHAFT STORAGE
- 6 UPR FUEL ELEMENTS TRAY
- 7 TRANSPORT GALLERIES
- 8 WORKING HALL
- 9 AUXILIARY STORAGE BAY
- 10 REPROCESSOR
- 11 VESSEL, VENTILATED STORAGE COMPARTMENT
- 12 REPROCESSOR
- 13 WATER TREATMENT
- 14 WELLS
- 15 CIRCULAR, CALCIUM HYDROXIDE
- 16 SLURRY CONCENTRATION SYSTEM
- 17 CIRCULAR TANK
- 18 MANHOLE
- 19 - " - "
- 20 TANK
- 21 ADMIXTURE/STORAGE BAY
- 22 CAPTAIN
- 23 MAIN GATE
- 24 PROCESSING CONTROL
- 25 ACCESS TUNNEL
- 26 ACCESS TUNNEL
- 27 PIPING DUCT
- 28 ESCAPE TUNNEL
- 29 EXIT TUNNEL
- 30 CABLE TUNNEL
- 31 CIRCULATING WATER PIPES
- 32 COMPRESSOR COOLING SYSTEM
- 33 COMPRESSOR COOLING SYSTEM
- 34 PROCESSING SPACE
- 35 MAIN TRANSPORT
- 36 REPROCESSOR
- 37 UPR BURNER
- 38 EMERGENCY COOLING WATER
- 39 EMERGENCY COOLING WATER
- 40 CONTROL
- 41 SPACE
- 42 ESCAPE SHAFT

Fig. 6 - 12 HTR plant layout

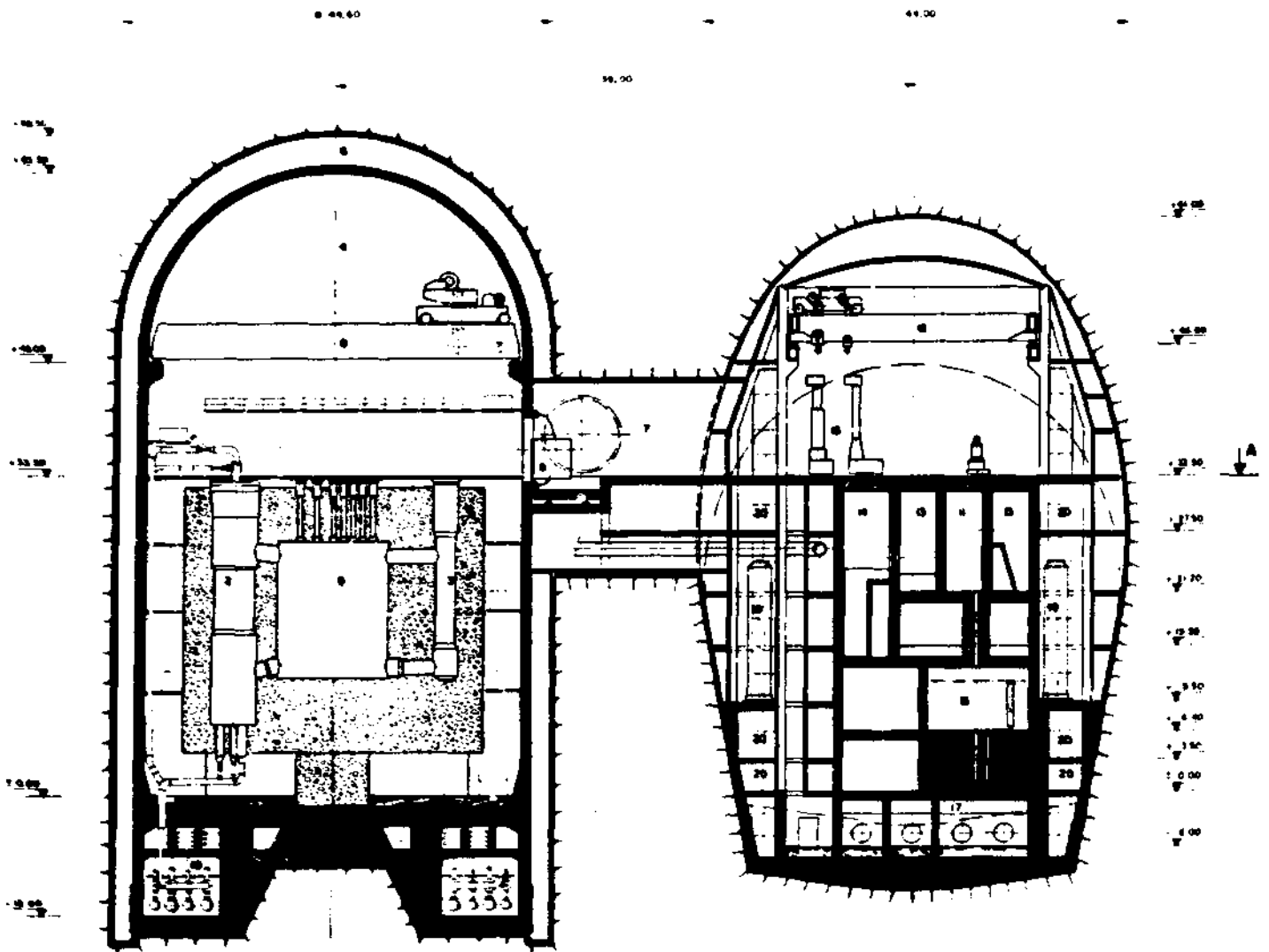

Fig. 6 - 13 HTR plant: vertical section

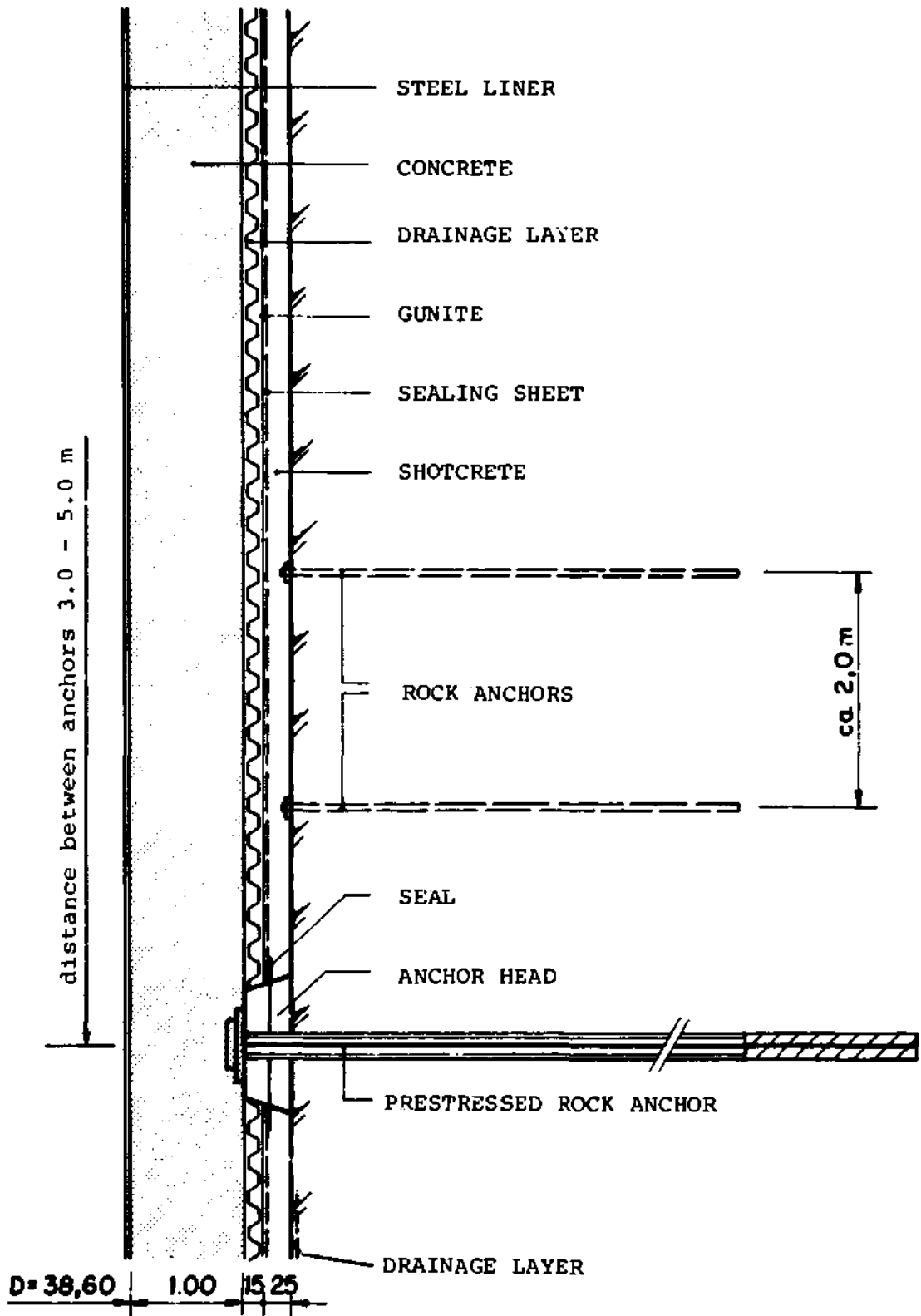

Fig. 6 - 14 HTR integrated containment system

marine Molasse (Helvétien). In spite of the relatively modest strength parameter, the undisturbed and relatively massive sandstones and marls provide acceptable conditions for cavern construction.

The site conditions are typical for the whole area of the Northern Swiss Molasse. In addition to this, the Molasse basin is a zone of low seismic activity, whereas the seismic intensities for a probability of 10^{-4} per year for the different regions of Switzerland vary between 7.6 and 9.6 (according to the MSK - scale) the corresponding seismic intensity of the site amounts to 7.8. This is typical again for wide areas of the Northern Swiss Molasse.

The complete plant is located above the maximum flooding level.

6.5.3. The plant layout is shown in Fig. 6 - 12.

The conventional part of the plant is located as close as possible to the reactor in a separate long cavern. In Fig. 6 - 13 is shown a section through the reactor cavity which is a right circular cylinder with a hemispherical dome 45 m in diameter and 85 m high. Inside the cavity is built a reactor containment 40 m in diameter to ensure as low as practical activity release and to protect the reactor against possible damage by falling rocks.

The service building is located in a rectangular cavity 44 m x 72 m with an egg - shaped cross section to provide a self - supporting cavern.

Access to the underground portion of the plant is by means of tunnels.

In Fig. 6 - 13 the containment is freestanding with room for inspection between the containment and cavern.

6.5.4. Fig. 6 - 14 shows an alternative to the freestanding annulus - type containment. The integrated containment system combines the functions of rock support, sealing, drainage and containment. Well - known construction elements of containment and cavern technique such as rock anchors, shotcrete, organic sealing materials, drainage layers (SAPE or similar products), concrete containment and a steel liner are used for this integrated containment system.

The relative positions of the caverns as well as their orientation within the hillside have been chosen to minimize connecting pipe runs and cabling. Further tunnels are provided for transport of large and heavy components, access and escape, pipelines, and cabling as well as ventilation.

In this study the emergency diesels are located in a bunkerized building outside the hill to minimize the number of tunnels required.

6.5.5. It has been estimated that an underground plant as that previously described would take about two years more to complete than a surface plant and that the cost would be about 20 % higher.

6.6. THE EIR PIT SITING STUDY (1976)

- 6.6.1. Within the scope of a more general investigation of the underground siting concepts, the Swiss Federal Institute for Reactor Research carried out in 1976 a preliminary study of the pit siting alternative (Ref. 6 - 7).

For this investigation, based on a 1000 MWe PWR, the plant has been devised completely underground since war protection has been assumed as a main task.

The main topics investigated are the depth of burial, the backfill thickness and the underground building disposition. This last point has been investigated mainly from the construction point of view.

- 6.6.2. The plant is assumed to be located on a flat site characterized by alluvial deposits of sufficient thickness to house the underground structures. Only the plant cooling system, ancillary equipment, offices and warehouses are located on the surface.

The proposed plant layout is shown in Fig. 6 - 15. The earth loadings on the underground buildings - about 50 t/m^2 in the lower section - require not only a considerable reinforcement of the structures but also a rearrangement of plant buildings. The proposed solution leads to arrange the fuel building, auxiliary building and electrical building around the reactor containment in such a way as to have a compact cylindrical structure. The turbine hall, housing also the main transformers has,

for the same structural reasons, the shape of a horizontal cylinder with domed end walls.

The same containment system of the reference plant, with a double containment, has been maintained. The containment system consists of a steel primary containment and a reinforced concrete secondary structure.

The steel primary containment has been preferred to a prestressed concrete structure to simplify the construction and to reduce the overall reactor building dimensions.

6.6.3. The depth of burial of this plant is about 30 m below the surface.

This depth has been determined in such a way as to achieve a balance between excavated material and backfill material.

To achieve protection against conventional warfare the plant must be covered by a first hard layer, capable to resist projectiles penetration and by a second softer layer of material capable of attenuating the shock of external impact and explosions.

The plant cover has a minimal thickness of 15 m and consists of 12 m of backfill material (soft layer), of a 2 m thick layer of concrete slabs or rock blocks (hard layer) and of a 1 m thick layer of humus.

6.6.4. The excavation of the large pit housing the plant is carried out in two stages: down to 17 m below grade the pit has sloped walls and terraces with space for construction facilities and roads for large excavation vehicles. From this elevation to the buildings foundations slurry walls or anchored cut - off walls will be used.

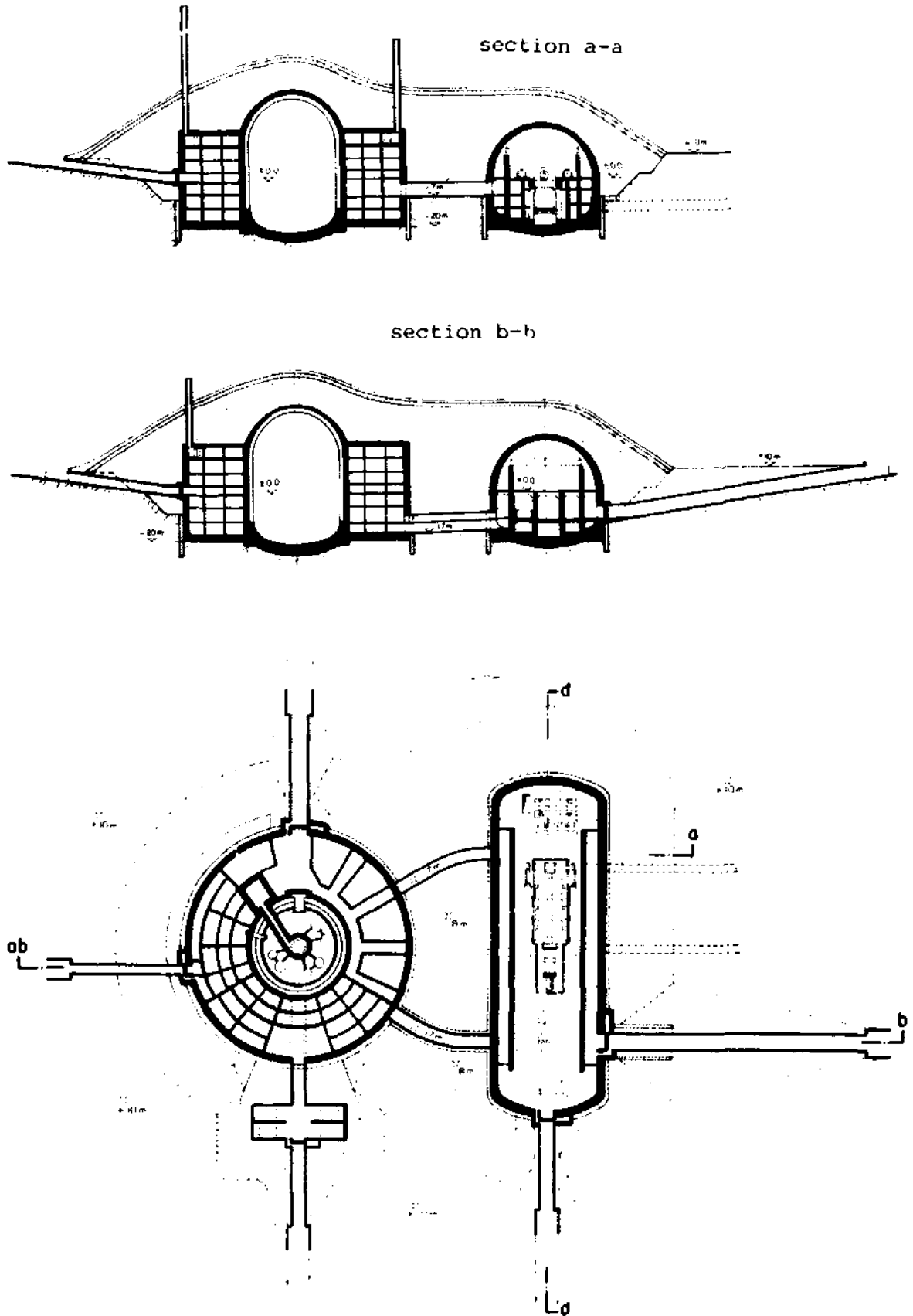

Fig. 6 - 15 EIR pit siting study 1976: plant layout

6.7. THE EIR PIT SITING STUDY (1977)

6.7.1. After the preliminary investigation of the pit siting concept (§ 6.6.), this siting alternative has been examined more in detail in a study performed in 1978, in order to evaluate its feasibility, safety potential and costs (Ref. 6 - 8; 6 - 9).

The desire for a realistic design, technical evaluation and costs estimate has led to choose a specific site for the location of the underground plant.

For this investigation, based on a three loop 3000 MWth NSSS developed by Westinghouse Europe, the following design criteria have been established:

- the underground plant should provide additional protection to the population and to the environment in case of major hypothetical accidents
- the underground plant should be better protected against external events, including aircraft crashes and sabotage
- the underground plant should fulfil the requirements of the licensing authorities

Protection against acts of war has not been required.

6.7.2. As a consequence of the criteria chosen for this study, only the nuclear island is located underground.

In particular, the reactor containment, the fuel building,

the auxiliary building, the steam and feed cells and the Notstand building are arranged around the reactor containment in such a way as to have a very compact structure (Fig. 6 - 16).

Material access is provided by means of two completely separate routes to the equipment hatch in the containment and to the cask entrance to the fuel building. The latter is also utilized for the auxiliary building.

These access routes consist of two tunnels, dimensioned for the transport of large components, running with a slight positive slope towards the underground plant. A handling area with a crane is provided at the top end of the tunnel for lowering or hoisting equipment and materials to and from the underground buildings through a vertical shaft.

The tunnels, equipped with blast resistant interlocked doors, are built at an angle to the horizontal plane to provide a shock wave pocket.

Personnel access way and cables ducts pass from the electrical building above ground to the underground auxiliary building.

Redundant ventilation inlets to the underground plant are provided at the sides of the turbine and electrical buildings. The exhaust stack is located between these two buildings.

- 6.7.4. The nuclear island, partly located in soil and partly in rock because of site characteristics, is covered, as well as the accesses, by about 12 m of backfill.

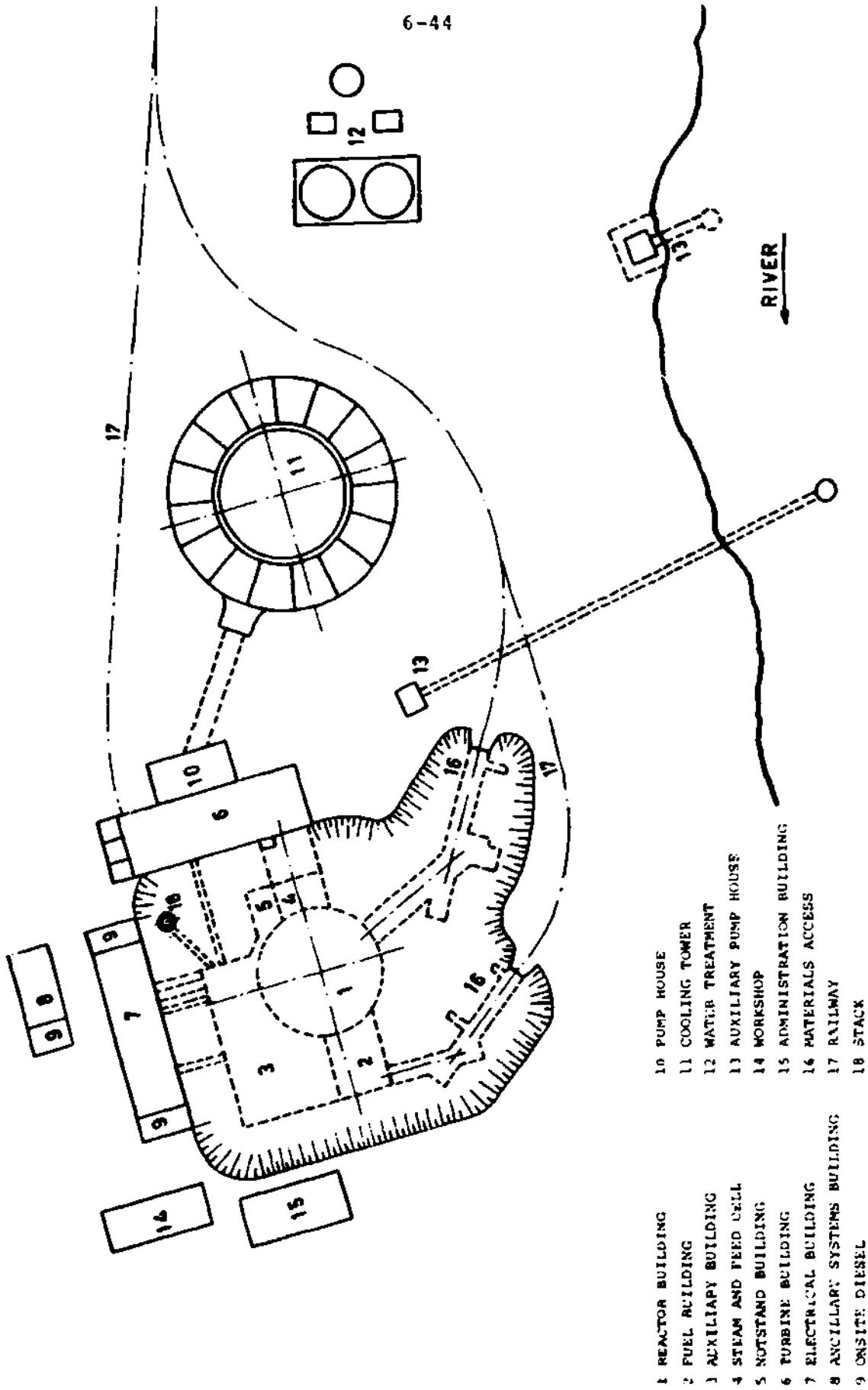

Fig. 6 - 16 Underground nuclear island plot plan

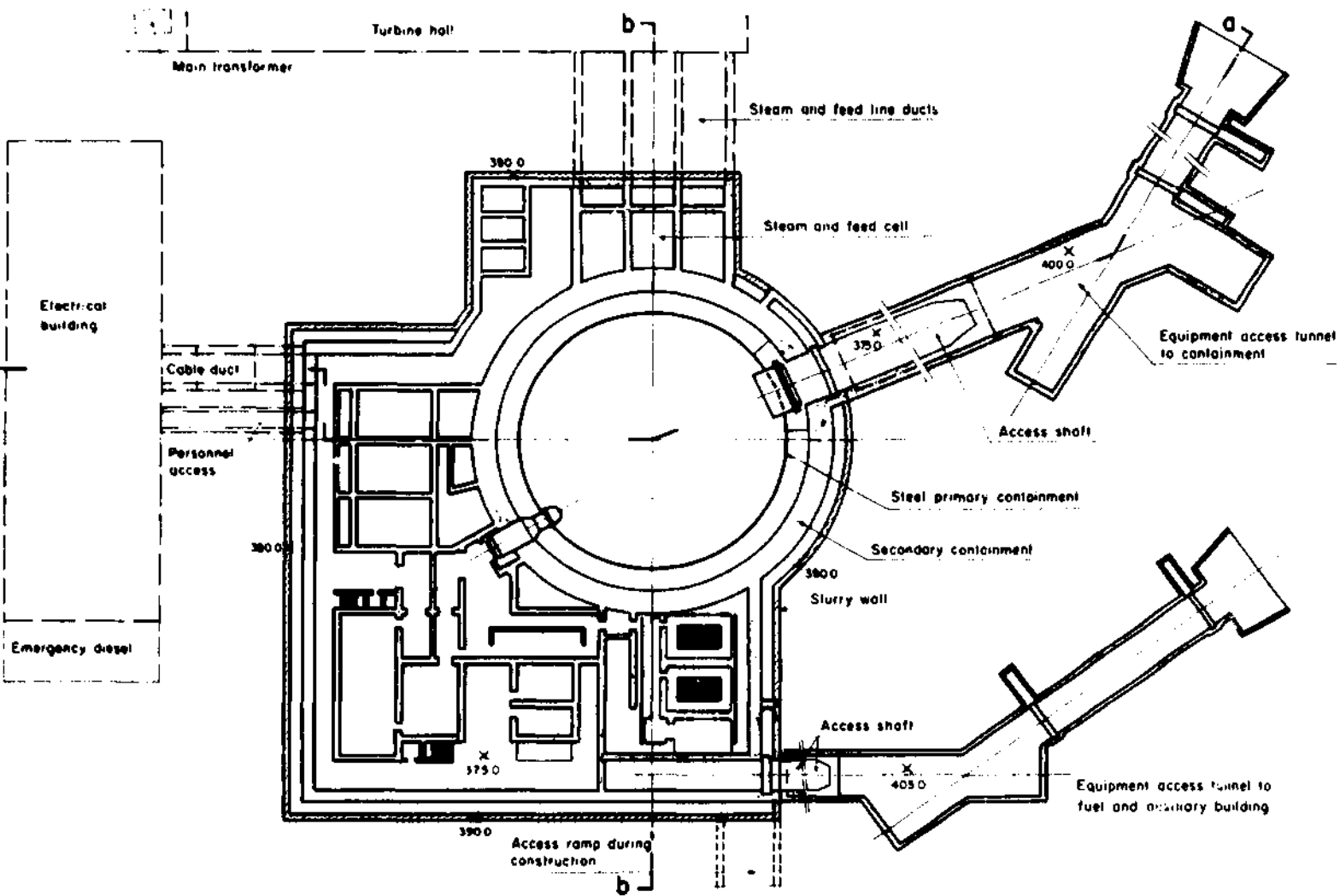

Fig. 6 - 17 Plant horizontal cross section

Section a - a

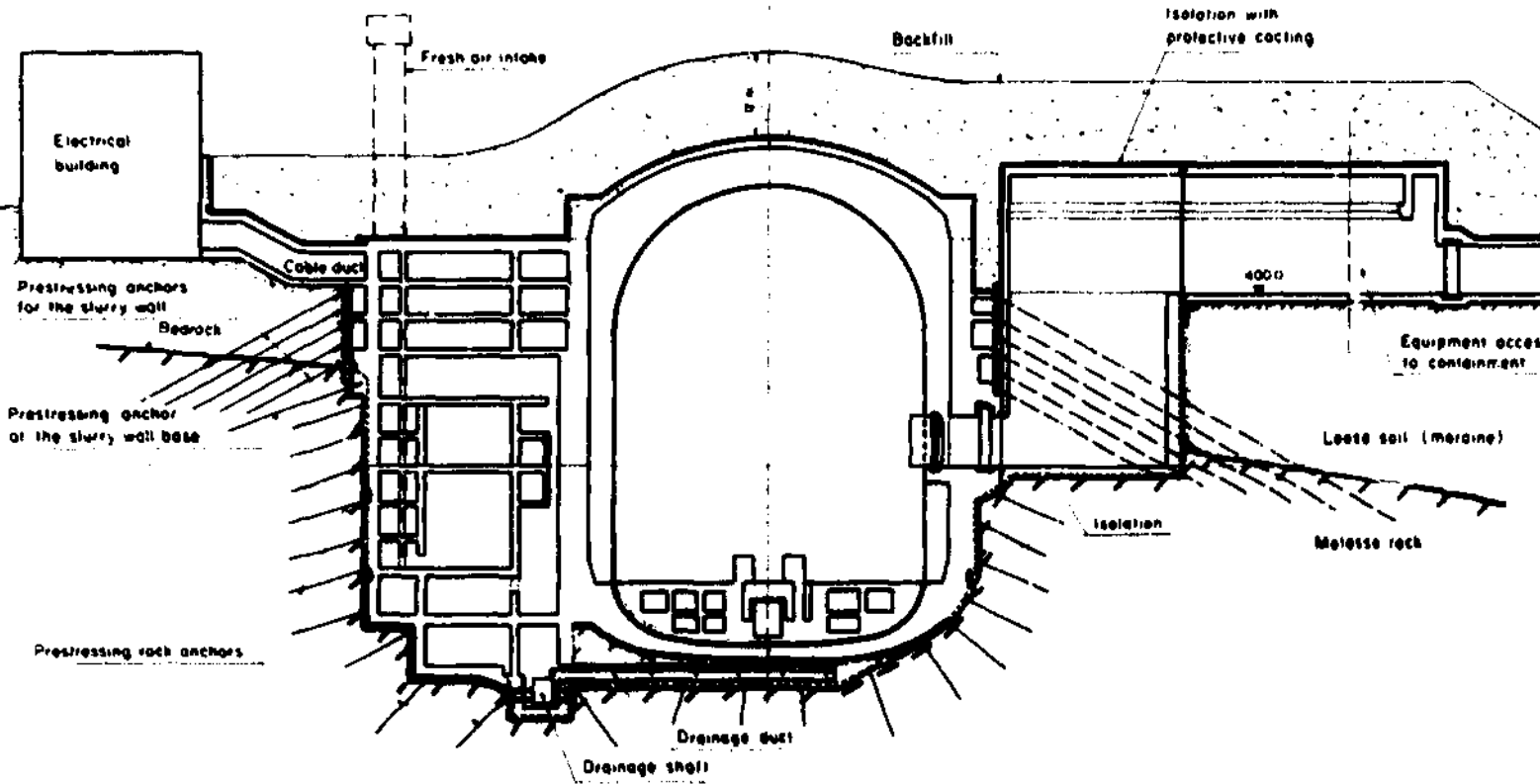

Fig. 6 - 18 Plant vertical cross section (section a-a)

Section b-b

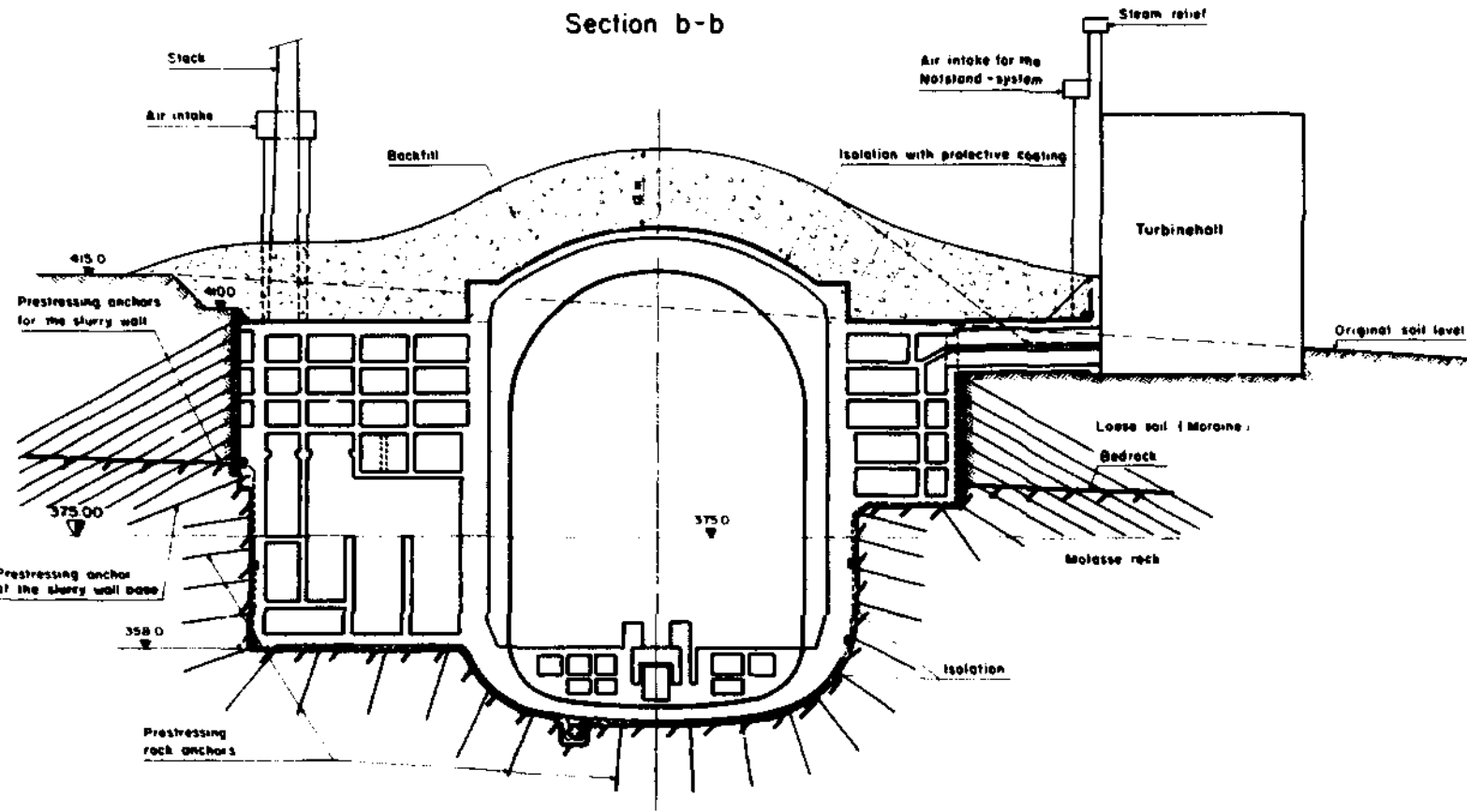

Fig. 6 - 19 Plant vertical cross section (section b-b)

This cover thickness is considered sufficient to protect the underground structures against external influences - including aircraft crashes - and to provide a complete fission products filtration in case of major accidents. The plant depth of burial is the result of a compromise between the attempt to minimize the problem of the disposal of the débris utilizing a large part of them (about 400 000 m³) for the backfill and to avoid, for structural reasons, too large earth loads on buildings with large internal openings (as, for instance, the fuel handling building) by locating them in rock.

- 6.7.5. The layout within the reactor building (a cylindrical concrete structure with a dome, 72 m max. internal height and 50 m internal diameter) is, in principle, the same as in the reference plant.

Exception is the height of the steam and feed penetrations increased by 14 m, the maximum possible without major rearrangements in the reactor building. This change has allowed a shifting of the steam and feed cells building to a higher elevation thus avoiding an excessive earth overburden on the structures. Moreover, for constructional reasons, the prestressed concrete primary containment has been replaced by a steel containment. Another difference, dictated by structural reasons, is given by the increased wall thickness of the secondary containment (about 4 m at the interface soil - rock).

The layout of the auxiliary building is also based closely to the reference design.

In the underground plant, the plant area is dictated by

the need to accommodate the safeguard pumps on the north side of the containment and the fuel building on the west. The levels of the basements are dictated by considerations such as the need for a positive suction head for pumps while the height of the building is dictated by the desire to avoid an excessive earth overburden which would impose on the structures unnecessarily high loads.

The freedom to vary the layout of the fuel building has been limited by the position of the fuel transfer duct. Relative to the reference design there has been some rearrangement of the shape and size of the storage pools and the position of the ventilation plant but the most important differences relate to the handling and decontamination arrangements for the irradiated fuel flask. These design differences have been dictated by the desire to raise the level at which the fuel flask enters the fuel building and by the fact that this same access route is also used for material access to the auxiliary building.

The exceptional emergency systems have been located in the north side of the steam and feed cells.

- 6.7.6. A system for mitigating the consequences of major hypothetical accidents, with a filtered vent system, has been proposed in this study.

Since one of the design criteria was to fulfil the requirements of the licensing authorities, an engineered charcoal filter system with redundant cooling and with independent and redundant power supply systems has been

taken into account. A passive venting system using, for instance, sand, gravel or rock beds or also water as a filter has not been proposed as a solution, mainly because of a lack of data on the efficiency and on the reliability of such beds.

In the proposed design, the underground plant has three lines of containment: the primary and secondary containment with the same functions as for above ground plants and an "earth" containment formed by the backfill and soil surrounding the plant together with the sealing sections of the access tunnels and service ducts connecting the underground structures with the surface.

The basic containment philosophy is to avoid a ground level release following primary and secondary containment failure without trying to keep the activity confined indefinitely underground.

This is achieved, after the "earth" containment has been pressurized as a consequence of an accident, by venting it through the secondary containment ventilation line to the stack, via an iodine filter, so that the pressure will not rise above the penetrations design pressure.

Leakages past seals, airlocks etc. will be collected by providing a second low pressure barrier. The interspaces will be kept below atmospheric pressure by a special exhaust system, located above ground, which passes the leakage through an iodine filter to the stack. The various seals, airlocks etc. are located in leaktight sections of ducts or tunnels at least 10 m long to ensure that at least 10 m of medium (earth or rock) filter any leakage from the underground portion of the plant before it reaches tunnel sections leading to the atmosphere.

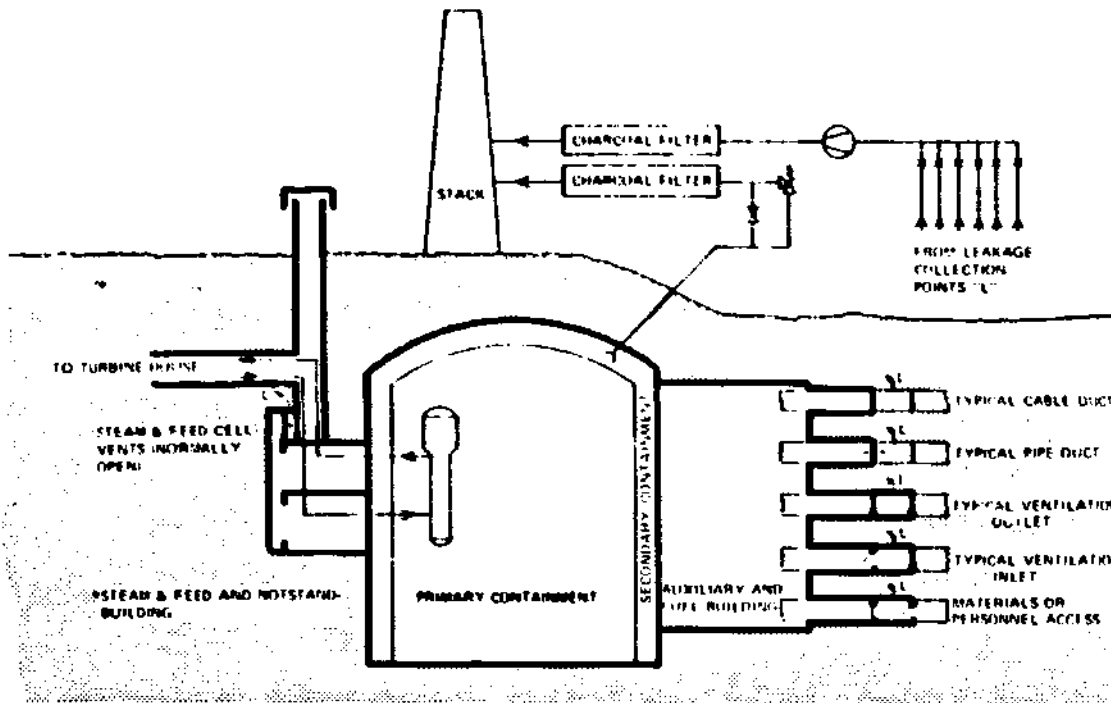

Fig. 6 - 20 Underground vented containment system

Leakages into the medium, if any, will be slow and, since the leakage has always to pass through the overburden thickness, only the noble gasses might reach the atmosphere (Ref. 6 - 10).

6.7.7. An alternative design to the one previously described has been shortly investigated. The underground plant has been located in the same site but in an area where the bedrock lies only a few meters below the surface. As a result, the plant is totally embedded in rock and covered with a layer of backfill material (Fig. 6 - 21). The plant layout is, however, the same as for the previous case.

The main advantages of this alternative are considered to be the following:

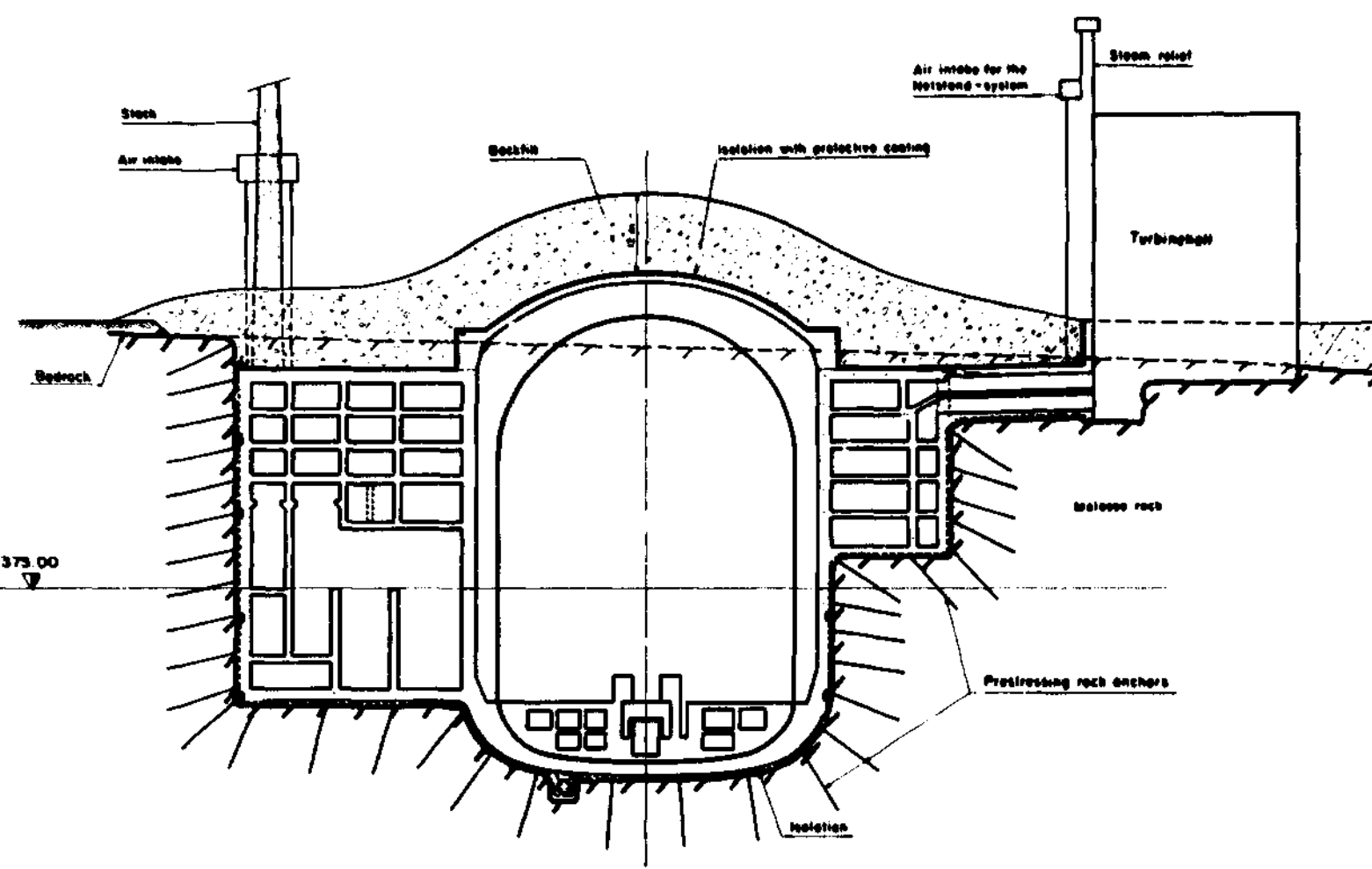

Fig. 6 - 21 Pit siting in rock: vertical section



- the construction procedure is simpler since due to the good rock quality no extensive pit securing measures (as, for instance, the anchored slurry wall of the previous alternative) are necessary
- the earth loadings on the underground buildings are reduced allowing therefore a simpler dimensioning of the structures
- the seismic behaviour of the underground structures, located in homogeneous material, is improved

Despite these potential advantages, this alternative has not been further investigated since it represents a special case adapted to the peculiar characteristics of the chosen site.

6.7.8. From the point of view of safety, the underground plant does not show any disadvantage compared with the reference plant from which it has been derived (Ref. 6 - 11). Safety during normal plant operation and the possibility of accidents occurring are not affected by the underground siting.

For what concerns accidents, up to the DBA there are no significant differences between the surface reference plant and the underground nuclear island.

Very few variations of accident scenarios have been identified. Design solutions have been devised to cope with them so that the influence of these differences on the overall plant safety is not relevant.

Events of possible concern such as flooding or fires are not more dangerous underground and can be easily handled.

The earth provides a better protection against low probability external events, natural and man related. Immunity to surface phenomena as storms, aircraft crashes, explosions etc. is achieved in the underground location while the effects of other external events as, for instance, earthquakes are mitigated.

The vented containment system proposed to mitigate the consequences of extreme hypothetical accidents, such as Class 9, appears to reduce risk for the general public. The performances of this system appear to be better not only than those of other underground containment concepts (as a full pressure containment or a containment vented to porous rock or gravel) but also than an equivalent above ground containment system (Ref. 6 - 12).

- 6.7.9. The plant can be built utilizing existing technologies and techniques. For securing the pit walls, the slurry trench technique has been chosen to reduce the amount of excavated material.

The construction time is increased by 30 months compared with a surface plant. This is mainly due to the pit excavation and slurry trench anchoring.

The cost increase is estimated to be about 11 %.

6.8. THE EIR ROCK CAVITY PLANT STUDIES (1978)

6.8.1. In order to complete the general investigation of the underground siting, started in 1975, the Swiss Federal Institute for Reactor Research examined again, taking advantage of the experience acquired with the studies of the pit siting, the rock cavity alternative.

Two studies have been completed in 1978: a first investigation has updated and completed the rock cavity study relative to a nuclear power plant completely located underground performed in 1975 while a second investigation has examined a plant partially located underground in artificial rock caverns (Ref. 6 - 13, 6 - 14).

To have a realistic base for the investigations two specific sites have been chosen. The 3000 MWth Nuclear Island developed by Westinghouse Europe has been taken as reference plant.

The design criteria followed in these investigations are the same as those fixed for the pit siting studies. In fact, a better protection for the general public and for the environment should be ensured in the case of major hypothetical accidents, protection against external events should be improved and the actual swiss licensing rules should be satisfied.

Furthermore, the plant completely underground should be protected against acts of conventional warfare to ensure power production during wartime.

6.8.2. The layout proposed for a nuclear power plant completely located underground is represented in Fig. 6 - 22 to 6 - 24. Since the plant is required to operate during wartime, all those components vital for plant operation or requiring long repair time have been located underground.

The layout consist of four main caverns, the reactor cavern, the auxiliary systems cavern (housing also the fuel building), the turbine cavern (housing also the main transformers), the electrical equipment cavern and several smaller caverns housing safety and ancillary systems. All caverns are interconnected by a large number of tunnels and galleries for personnel, cables, piping and ventilation.

6.8.3. The reactor cavern is cylindrical in shape with an excavation diameter of 46 m and a maximum height of about 70 m.

A double containment system has been maintained in the underground location. The primary containment is a free-standing steel shell while the secondary containment is constituted by the cavern walls and the concrete lining. The filtered vent system proposed for the pit siting has been adopted also for this siting concept.

The three remaining large caverns, housing the turbo-group, the auxiliary systems and the electrical equipment are horseshoe shaped, elongated caverns.

The dimensions of the turbine cavern are 140 m length, 30 m width and 40 m height. The auxiliary systems cavern is 120 m long, 26 m wide and 34.5 m high while the elec-

Electrical equipment cavern

Auxiliary systems cavern

Turbine cavern

Cooling water

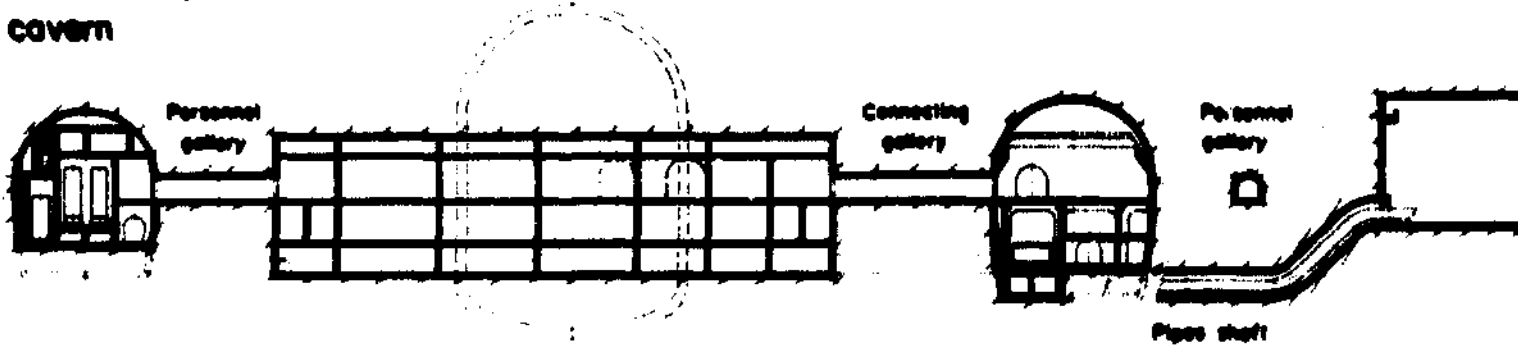

Reactor cavern

Auxiliary systems cavern

Turbine cavern

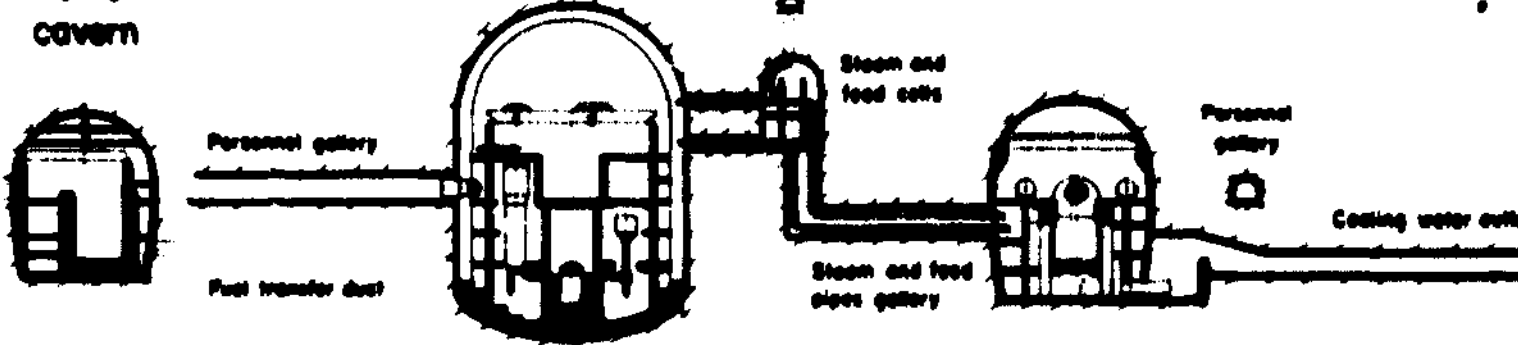

Fig. 6 - 23 Plant totally in rock cavities: sections

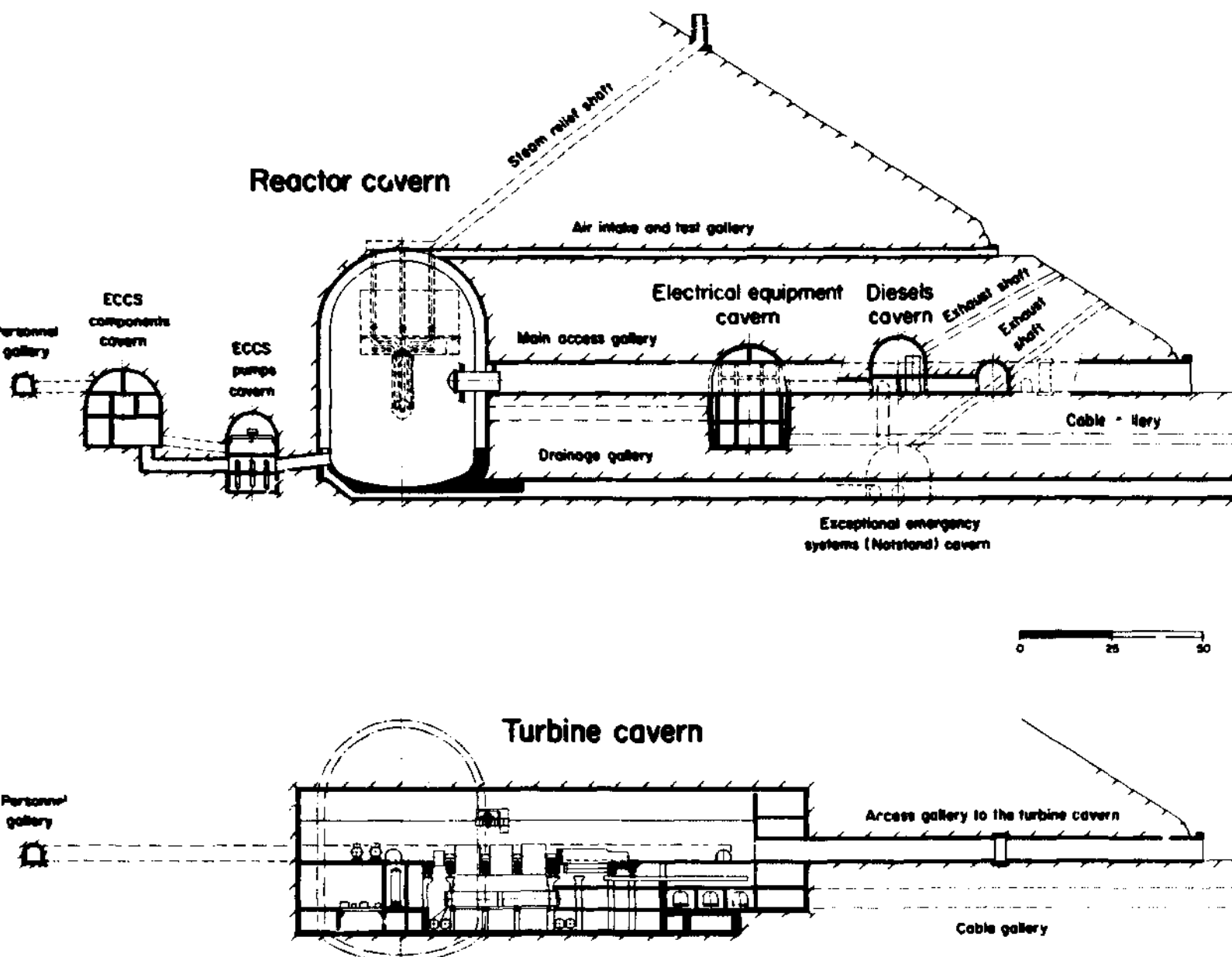

Fig. 6 - 24 Plant totally rock cavities: sections

trical equipment cavern is 110 m long, 20 m wide and 28 m high.

All these caverns are connected by a large number of tunnels and galleries for personnel, transport of components, cables, piping etc.

- 6.8.4. All main caverns are provided with an access tunnel which allows their simultaneous excavation. An exception is the reactor cavern that will be excavated from an exploration tunnel (Fig. 6 - 23) running at the top of the cavity.

The access tunnel to the reactor cavern, dimensioned for the transport of large components, has been designed with an angle to the horizontal plane to provide a shock wave pocket.

Personnel access to the underground plant is through the electrical equipment cavern access tunnel. Access to the main caverns, with the exception of the reactor cavern, is from the electrical equipment cavern through a long tunnel surrounding the whole plant. This same tunnel is used as escape route.

Personnel access to the reactor cavern is from the auxiliary systems cavern, by means of a gallery and containment personnel hatch.

All tunnels connecting the plant with the outside are equipped with interlocked blast and fire resistant doors.

6.8.5. The layout proposed for the rock cavity plant in 1975 (Fig. 6 - 6) is in principle still valid.

Some modifications have however been introduced, the most important of which are (Fig. 6 - 22)

- the location of the emergency core cooling systems in two different caverns
- the location of the steam and fuel cells in a separate cavern.

Other minor differences are given by a slightly different location of the main caverns and by a different tunnel system.

6.8.6. The plant construction technique has not been modified. However, with the new reference plant, the reactor cavern requires a larger span (46 m instead of 40.5) and therefore the rock volume to be excavated is considerably larger (95000 m³ instead of 75000 m³). This fact results in a 6 month increase in construction time as compared with the 1975 study. Therefore the plant construction time is about 30 months longer than for an equivalent surface facility.

The cost increase is about 14 %.

6.8.7. The partial underground location of a nuclear power plant in rock cavities has been investigated in a separate study (Ref. 6 - 14). In this study, only those plant components which either represent a potential risk (for instance because of their radioactive inventory) or require adequate protection from external events have

been located underground.

On the basis of a site survey, a specific site has been chosen and a detailed layout has been prepared. This layout, represented in Fig. 6 - 25, has been sensibly influenced by the study of the partial location in soil and by the updating of the previous rock cavity study.

The aboveground portion of the plant is arranged in front of the hill housing the underground facility and includes the turbine building, the electrical building, ancillary buildings and the cooling towers. The underground section includes the reactor cavern, the auxiliary systems cavern, two small caverns for the Safety Injection Systems, the steam and feed cells cavern and the Exceptional Emergency Systems (Notstand systems) cavern.

The reactor cavern is cylindrical in shape, 46 m in diameter and 70 m maximum height, while the auxiliary systems cavern is horseshoe shaped, 120 m long and 32 m wide. The fuel handling building is located in this cavern.

All the caverns are connected by a system of tunnels and galleries: access to the plant is through three main tunnels.

- 6.8.8. The site topography requires that access to the tunnels be made through ramps. One large ramp with a maximum slope of 10 % leads to the auxiliary systems cavern and to the reactor cavern access tunnel. A second smaller and steeper ramp reaches the reactor cavern exploration tunnel. This ramp is mainly used during the excavation of the reactor cavern.

Components and material access during plant construction and operation is through the main tunnels to the reactor building and the auxiliary systems cavern.

All the tunnels connecting the underground plant with the outside are equipped with interlocked blast and fire resistant doors. Furthermore the tunnels, as in the previous study, are laid out in such a way as to avoid a direct hit to the cavern entrance.

Personnel access to the underground portion of the plant is from the electrical building, which houses the plant control room, by means of a long tunnel surrounding the whole underground facility at reactor floor elevation. This tunnel is also used as escape route.

Personnel access to the reactor cavern is from the auxiliary systems cavern through a tunnel leading to the containment personnel hatch.

- 6.8.9. Since the excavation of the reactor cavern has proved to be the time determining factor and the adopted layouts allow the simultaneous excavation of all main caverns, this alternative requires practically the same construction time of the plant totally underground in rock cavities.

Therefore, also in this case, the construction time, if compared with a conventional surface siting, is extended by about 30 months.

The cost increase is instead about 11.4 %.

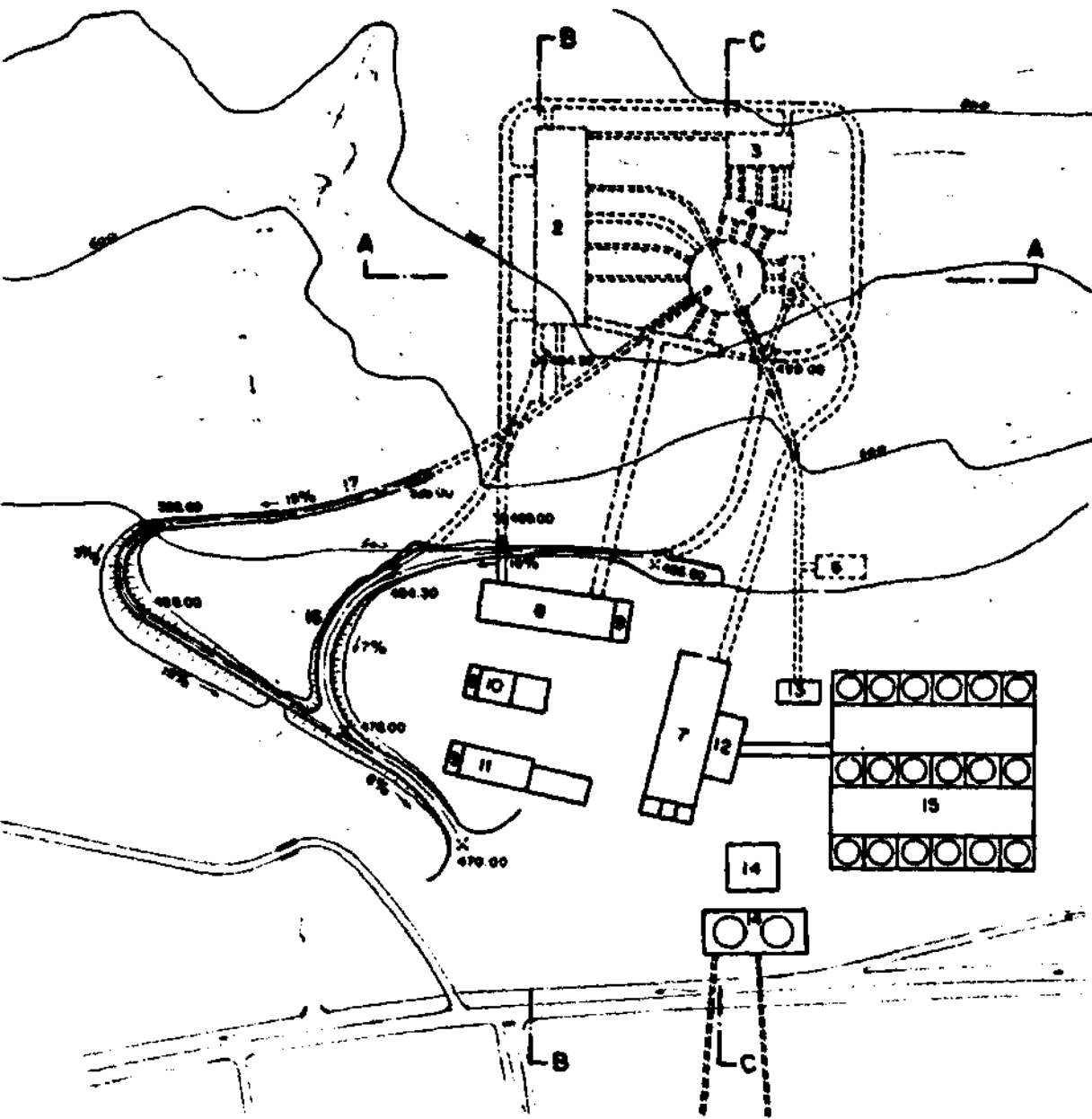

1. Reactor cavern
2. Auxiliary systems
3. SIS components cavern
4. SIS pumps cavern
5. Steam and feed cavern
6. Muti-stand systems cavern
7. Turbine house
8. Electrical building
9. Emergency diesel
10. Ancillary systems
11. Workshop
12. Pump house
13. Auxiliary pump house
14. Water treatment
15. Cooling tower
16. Access ramp
17. Construction ramp

Fig. 6 - 25 Nuclear island in rock cavities: plan

6.9. COMPARISON AMONG THE STUDIES

6.9.1. Almost all the studies previously described are detailed investigations meant to evaluate the feasibility, the safety potential, the advantages, the disadvantages and the economical penalties of the underground siting. However, it should be noted that protection against acts of war and power production during wartime has also been an important motivation for some of these studies.

Two of the main variations of the underground siting concept have been taken into account. The rock cavity plant and the pit siting have been thoroughly investigated for plants located totally or partially below grade.

All these studies, with the exception of a HTR rated 1160 MWe, are based on light water reactors rated about 1000 MWe.

The main characteristics of these investigations are summarized in table 6 - 1.

6.9.3. According to these studies the underground siting is feasible and without requiring the development of new construction techniques.

Main advantages of the underground siting are considered the potential improved protection of the public and the environment following major hypothetical accidents, the enhanced protection against external events (including acts of war) and a possible better public acceptance.

6-66

The rock cavity plant and the pit siting have been considered the most suitable underground siting alternatives for Switzerland.

STUDY	YEAR	REACTOR TYPE & RATING	PLANT CONFIGURATION	CONTAINMENT TYPE & DIMENSIONS (l x w x h) m	COST INCREASE VS A SURFACE PLANT	INCREASE IN CONSTRUCTION TIME (months)
ELEKTROWATT ENGG. LTD.	1972	PWR 1000 MWe	both hillside and deep below the surface locations have been considered	cylindrical cavern lined with concrete $\phi_i = 35 \text{ m}$ $h = 63 \text{ m}$	45 - 50 %	
		BWR 1000 MWe		cylindrical cavern lined with concrete $\phi_i = 48 \text{ m}$ $h = 72 \text{ m}$		
EIR	1975	PWR (Westinghouse) 1000 MWe	hillside plant totally underground in various caverns	conventional containment in a cylindrical cavern $\phi = 42 \text{ m}$ $h = 63 \text{ m}$	11 %	24
MOTOR COLUMBUS	1975	BWR (GE. BWR6 Mark II) 1000 MWe	hillside plant totally underground in two main caverns	rectangular cavern containing also the auxiliary systems 197 x 33 x 70.7	25 - 30 %	18 - 24
MOTOR COLUMBUS	1975-1976	HTGR (G.A.) 1160 MWe	hillside plant partially underground	free-standing containment in a cylindrical cavern $\phi = 45 \text{ m}$ $h = 85 \text{ m}$	20 %	24
EIR	1976-1977	PWR (Westinghouse) 1000 MWe	pit sited plant (semi embedded) partially and totally underground layouts	cylindrical double containment $\phi_i = 43 \text{ m}$ $h_i = 67 \text{ m}$	11 %	30
EIR	1978	PWR (Westinghouse) 1000 MWe	hillside plant partially underground	double containment in a cylindrical cavern $\phi = 46 \text{ m}$ $h = 70 \text{ m}$	11.4 %	30
			hillside plant totally underground		14 %	30

Table 6 - 1 Some characteristics of the main swiss studies

6.10. CONCLUDING REMARKS

6.10.1. Some of the main studies performed in Switzerland on the underground siting of nuclear power plants in the last years have been examined in this chapter.

Common motivation to these studies is the evaluation of the feasibility of the underground siting in Switzerland and the assessment of advantages and disadvantages of the siting, of its safety potential and of the cost penalty associated with it. Another motivation common to some of the studies is the protection against acts of conventional warfare.

6.10.2. The pit siting and the rock cavity alternative have been investigated and detailed plant layouts have been proposed, taking LWRs as reference plants. Furthermore, to allow a realistic comparison with above ground plants, specific sites have been chosen.

A study (Ref. 6 - 12) has dealt with a quantitative evaluation of the risk reduction afforded by the underground siting following a major hypothetical accident. The results of this investigation confirm the safety potential of the siting.

The cost of undergrounding a nuclear power plant rated about 1000 MWe appears to be between 25 - 30 % (Ref. 6 - 5) and 11 % (Ref. 6 - 10). The construction time is estimated to be 2 to 2 1/2 years longer than for an equivalent surface plant.

References

- 6-1 A. Wanner. W. Winkler
Underground nuclear power stations
Nuclex 72, 16 - 21 Oct. 1972, Basel.
- 6-2 EIR
Kernkraftwerk in Kavernen
Studie 1975
TM-ST-438, Nov. 1976
- 6-3 A. Plancherel
Réfrigération des centrales nucléaires en caverne
Memo-ST-177, Aug. 1976
- 6-4 ETHZ Institut für Strassen- und Untertagbau
Studie über die Stabilität grosser Kavernen
zylindrischer Form
Dezember 1975
- 6-5 Motor-Columbus
Kernkraftwerk in Kavernen
Phase I, 1975
- 6-6 Motor-Columbus
- 6-7 EIR
Kernkraftwerk in Lockergestein
Studie 1976

- 6-8 EIR
Kernkraftwerk in Lockergestein
Studie 1977
Dezember 1977
- 6-9 EIR
Layout study for an earth covered PWR nuclear
power station
December 1977
- 6-10 S. Pinto, P. Gibbs, P. Telleschi
Layout and containment concept for an underground
nuclear power plant
ANS 1978 Annual Meeting, S. Diego, Calif.
- 6-11 S. Pinto
A safety assessment of a nuclear power plant in
an open cut excavation
TM-ST-572, November 1978
- 6-12 EIR
Alternative Containment Systems. A quantitative
comparison
December 1978
- 6-13 EIR
Kernkraftwerk in Kavernen
Weiterbearbeitung der Studie 1975
Dezember 1978
- 6-14 EIR
Kernkraftwerk in Kavernen
Teilweise Unterirdische Anordnung
Studie 1978
Dezember 1978